

Powered by



# HRL 12540W ▶ 12V 540W

HRL 12540W is specially designed for high efficient discharge application. Its characteristics are high energy density, small footprint and high discharge efficiency. It can be used for more than 260 cycles at 100% discharge in cycle service, up to 10 years in standby service.



## Specification

Cells per unit	6
Voltage per unit	12
Capacity	540W @ 15min-rate to 1.67V per cell @25 °C(77°F)
Weight	Approx.43.9 kg(96.7 lbs)
Maximum Discharge Current	800A(5sec)
Internal Resistance	Approx. 4 mΩ
Operating Temperature Range	Discharge: -15°C~50°C ( 5°F~122°F) Charge: -15 °C~40°C ( 5°F~104°F) Storage: -15°C~40°C ( 5°F~104°F)
Nominal Operating Temperature Range	25°C±3°C (77°F±5°F)
Float Charging Voltage	13.5 to 13.8 VDC/unit Average at 25°C (77°F)
Recommended Maximum Charging Current Limit	54A
Equalization and Cycle Service	14.4 to 15.0 VDC/unit Average at 25°C (77°F)
Self Discharge	CSB Batteries can be stored for more than 6 months at 25°C (77°F). Please charge batteries before using. For higher temperatures the time interval will be shorter.
Terminal	I2-Thread lead alloy recessed terminal to accept M6 bolt (M8 bolt also available upon request)
Container Material	Polypropylene(UL94-V0)*Flammability resistance can be available upon request.



CSB-manufactured **VRLA** (Absorbent Glass Mat type) batteries are UL-recognized components under UL1989.

CSB is also certified by ISO 9001 and ISO 14001.

## Dimensions :

Overall Height (H)	Container height (h)	Length (L)	Width (W)
Unit: mm (inch)	275.7±2.5(10.85±0.1)	273.2±2.5 (10.76±0.1)	343±2.5 (13.5±0.1)
			170±2 (6.69±0.08)

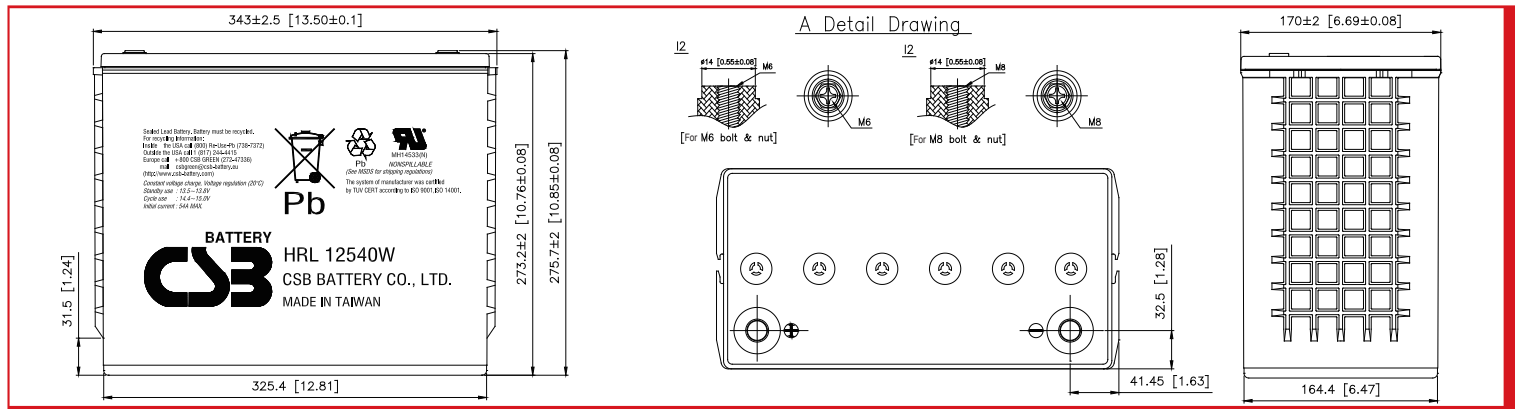

## Constant Current Discharge Characteristics Unit:A (25°C, 77°F)

F.V/Time	2MIN	4MIN	6MIN	8MIN	10MIN	15MIN	20MIN	30MIN	60MIN	90MIN
1.60V	720	572	498	436	394	308	256	187	106	75.5
1.67V	608	517	452	406	370	294	245	181	105	74.3
1.70V	564	493	430	392	354	286	240	178	103	73.8
1.75V	501	440	398	365	327	270	228	172	101	72.0
1.80V	430	391	362	323	296	252	209	161	97.9	70.3
1.85V	379	340	304	282	265	222	187	147	90.3	66.2

## Constant Power Discharge Characteristics Unit:W (25°C, 77°F)

F.V/Time	2MIN	4MIN	6MIN	8MIN	10MIN	15MIN	20MIN	30MIN	60MIN	90MIN
1.60V	6874	5883	5176	4688	4186	3421	2716	2057	1224	885
1.67V	6207	5325	4794	4282	3885	3250	2630	2006	1210	865
1.70V	5768	4937	4544	4016	3661	3097	2564	1988	1201	863
1.75V	5225	4639	4196	3766	3472	2951	2454	1925	1174	849
1.80V	4561	4310	3818	3442	3233	2723	2306	1846	1129	824
1.85V	4227	3643	3356	3146	3010	2443	2104	1715	1061	784

Ratings presented herein are subject to revision without notice. Please refer to [www.csb-battery.com](http://www.csb-battery.com) to confirm the latest version.

### Trickle (or Float) Service Life

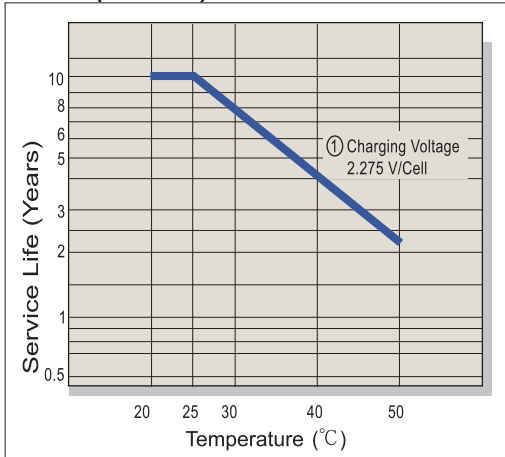

### Capacity Retention Characteristic

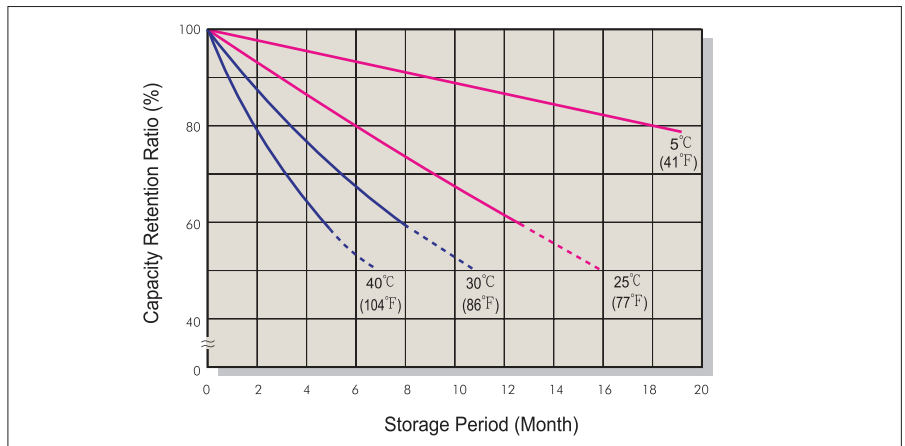

### Battery Voltage and Charge Time for Standby Use

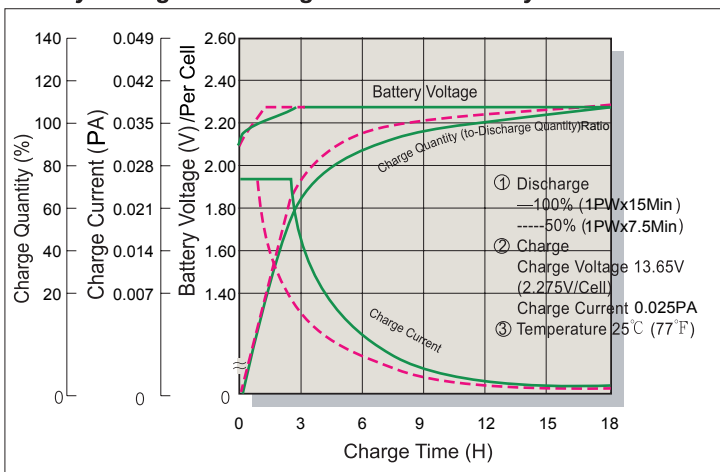

### Cycle Service Life

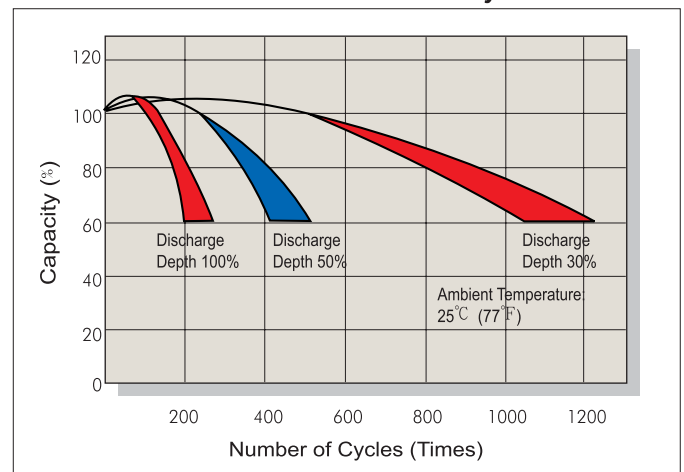

### Battery Voltage and Charge Time for Cycle Use

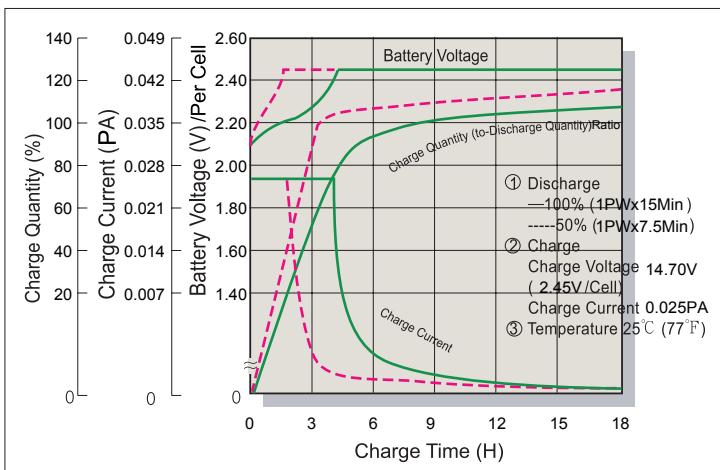

### Terminal Voltage (V) and Discharge Time

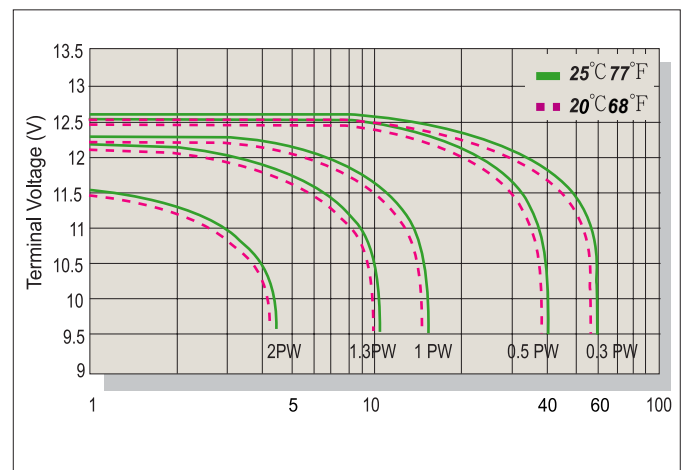

### Charging Procedures

Application	Charge Voltage(V/Cell)			Max.Charge Current
	Temperature	Set Point	Allowable Range	
Cycle Use	25°C(77°F)	2.45	2.40~2.50	0.1PA
Standby	25°C(77°F)	2.275	2.25~2.30	

### Discharge Current VS. Discharge Voltage

Final Discharge Voltage V/Cell	1.75	1.70	1.60	1.30
Discharge Power(W)	0.1P>(W)	0.1P≤(W)<0.25P	0.25P≤(W)<1.0P	(W)≥1.0P

Sales Office URL: [WWW.CSB-BATTERY.COM](http://WWW.CSB-BATTERY.COM)

**GLOBAL HQ**  
**CSB BATTERY CO., LTD. (TAIWAN)**  
 Tel : +886-2-2880-5600  
 Fax : +886-2-2888-3300  
 mail : service@csb-battery.com.tw

**BEIJING OFFICE. (CHINA)**  
**CSB BATTERY TECHNOLOGIES (BEIJING) CO., LTD.**  
 Tel : +86-10-5820-5336/5338  
 Fax : +86-10-58203053  
 mail : chinasisl@csb-battery.com

**AMERICA HQ**  
**CSB BATTERY TECHNOLOGIES INC. (U.S.A)**  
 Tel : +1-817-244-7777/1-(800)3-CSB-USA(272872)  
 Fax : +1-817-244-4445  
 mail : csb@csb-battery.com

**SHANGHAI OFFICE. (CHINA)**  
**CSB BATTERY LOGISTIC (SHANGHAI) CO., LTD.**  
 Tel : +86-21-5046-1622/5046-0833  
 Fax : +86-21-5064-1046  
 mail : chinasisl@csb-battery.com

**EUROPE HQ**  
**CSB Battery Europe BV.**  
 Tel : +31(0)-180-418-140  
 Fax : +31(0)-180-418-327  
 mail : eurosales@csb-battery.eu

**SHENZHEN OFFICE.( CHINA )**  
**CSB BATTERY LOGISTIC ( SHANGHAI ) CO., LTD.**  
 Tel : +86-755-8831-6488/6396/6356  
 Fax : +86-755-8831-6548  
 mail : she@csb-battery.com.cn