

HC 1225W

12V 25W

HC 1225W is specially designed for high efficient discharge application. Its invisible terminal can be inserted PC board directly. HC series battery can serve more than 260 cycles at 100% discharge in cycle service, or three to five years in standby service.



Specification

Cells Per Unit	6
Voltage Per Unit	12
Capacity	25W @ 15minute-rate to 1.67V per cell @25 °C (77°F)
Weight	Approx. 2.25kg(5.0 lbs)
Maximum Discharge Current	60A(5sec)
Internal Resistance	Approx. 30mΩ
Operating Temperature Range	Discharge: -15°C~50°C (5°F~122°F) Charge: -15~40°C (5°F~104°F) Storage: -15°C~40°C (5°F~104°F)
Nominal Operating Temperature Range	25°C±3°C(77°F±5°F)
Float Charging Voltage	13.5 to 13.8 VDC/unit Average at 25°C(77°F)
Recommended Maximum Charging	2.5A
Current Limit	
Equalization and Cycle Service	14.4 to 15.0 VDC/unit Average at 25°C(77°F)
Self Discharge	CSB Batteries can be stored for more than 6 months at 25°C(77°F). Please charge batteries before using. For higher temperatures the time interval will be shorter.
Terminal	Faston Tab 187/250
Container Material	-ABS (UL94-HB)*Flammability resistance of UL94-V2 can be available upon request.

CSB-manufactured batteries are UL-recognized components under UL924 as well as certified by ISO 9001 and ISO 14001.

Dimensions

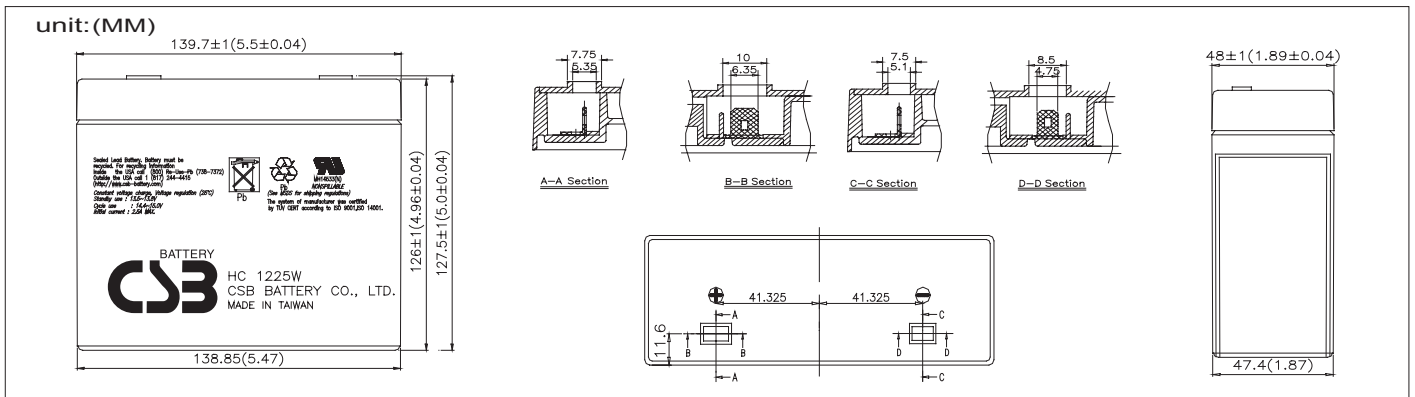

Constant Current Discharge Characteristics Unit:A (25°C,77°F)

F.V/Time	2MIN	4MIN	6MIN	8MIN	10MIN	15MIN	20MIN	30MIN	60MIN	90MIN
1.60V	47.83	35.25	28.25	23.00	18.08	13.33	11.92	9.08	5.28	3.21
1.67V	44.10	33.27	26.62	21.66	17.32	13.04	11.68	8.91	5.12	3.06
1.70V	42.50	32.42	25.92	21.08	17.00	12.92	11.58	8.83	5.05	2.99
1.75V	40.04	30.59	24.46	20.00	16.21	12.59	11.29	8.67	5.03	2.84
1.80V	37.58	28.75	23.00	18.92	15.42	12.25	11.00	8.50	5.00	2.68
1.85V	35.12	26.92	21.54	17.84	14.63	11.92	10.71	8.34	4.98	2.53

Constant Power Discharge Characteristics Unit:W (25°C,77°F)

F.V/Time	2MIN	4MIN	6MIN	8MIN	10MIN	15MIN	20MIN	30MIN	60MIN	90MIN
1.60V	574.00	423.00	339.00	276.00	217.00	160.00	143.00	109.00	63.40	38.50
1.67V	529.20	399.20	319.40	259.90	207.90	156.50	140.20	106.90	61.44	36.68
1.70V	510.00	389.00	311.00	253.00	204.00	155.00	139.00	106.00	60.60	35.90
1.75V	480.50	367.00	293.50	240.00	194.50	151.00	135.50	104.00	60.30	34.00
1.80V	451.00	345.00	276.00	227.00	185.00	147.00	132.00	102.00	60.00	32.10
1.85V	421.50	323.00	258.50	214.00	175.50	143.00	128.50	100.00	59.70	30.20

● All mentioned values are average values.

Trickle (or Float) Service Life

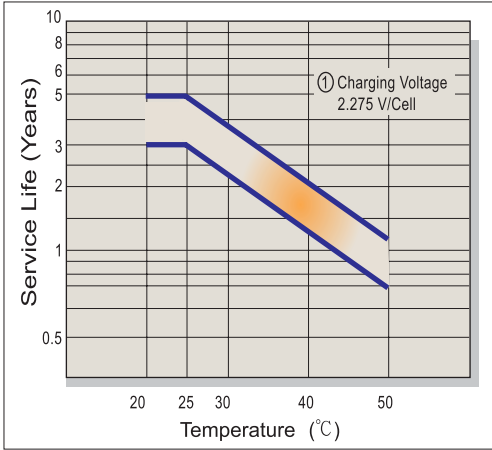

Capacity Retention Characteristic

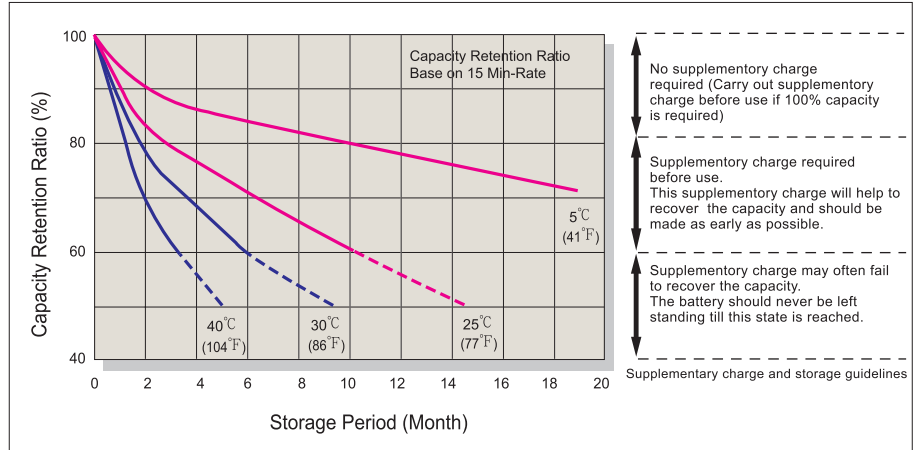

Battery Voltage and Charge Time for Standby Use

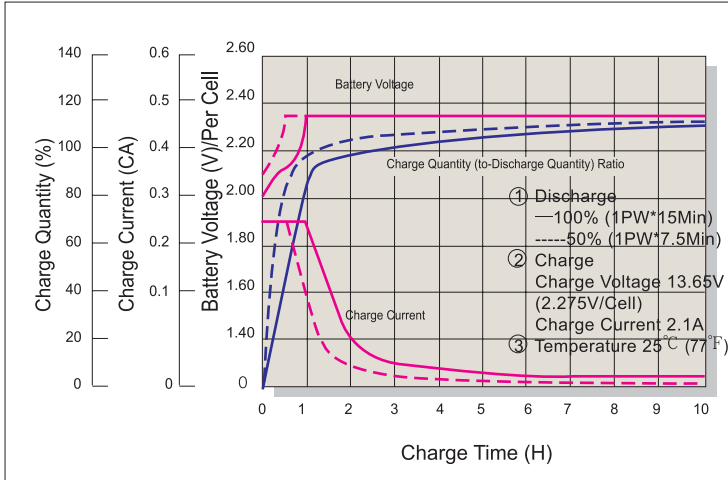

Cycle Service Life

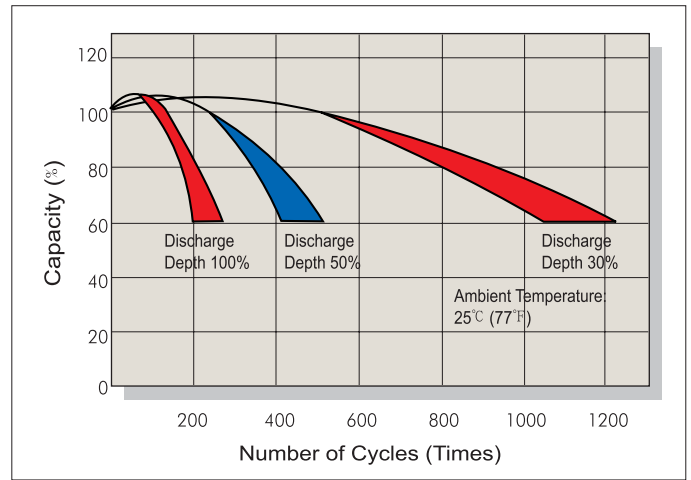

Battery Voltage and Charge Time for Cycle Use

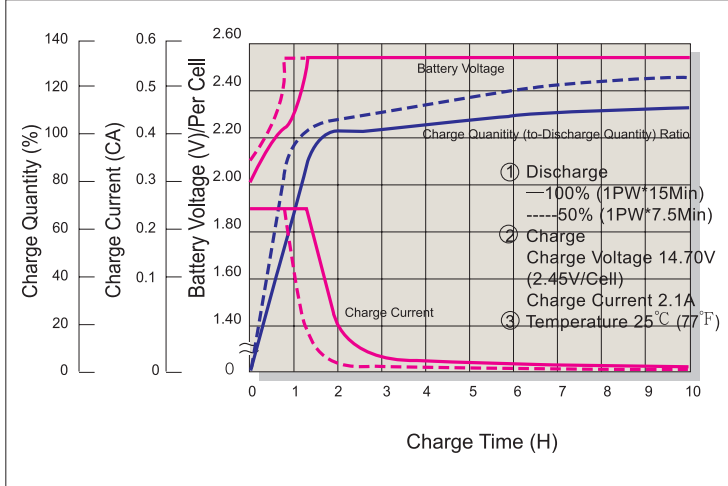

Terminal Voltage (V) and Discharge Time (25°C 77°F)

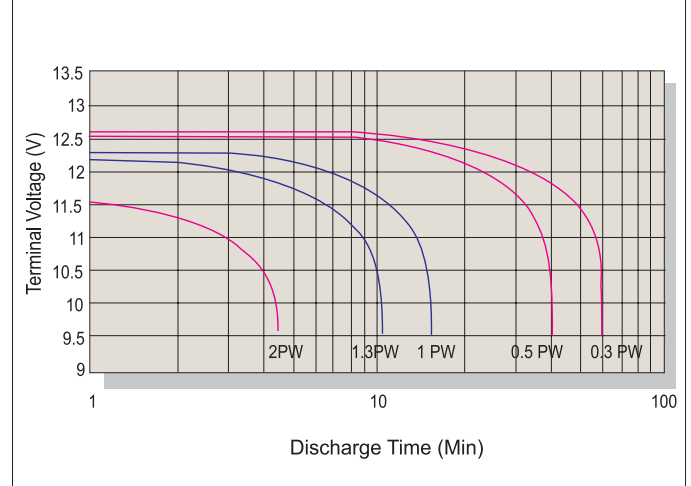

Charging Procedures

Application	Charge Voltage (V/Cell)			Max. Charge Current
	Temperature	Set Point	Allowable Range	
Cycle Use	25°C (77°F)	2.45	2.40~2.50	0.3C
Standby	25°C (77°F)	2.275	2.25~2.30	

Discharge Current VS. Discharge Voltage

Final Discharge Voltage V/Cell	1.75	1.70	1.55	1.30
Discharge Current (A)	0.2C>(A)	0.2C<(A)<0.5C	0.5C<(A)<1.0C	(A)>1.0C

Sales Office URL: WWW.CSB-BATTERY.COM

CSB BATTERY CO., LTD.
TAIWAN OFFICE
Tel: +886-2-8751-5000
Fax: +886-2-8751-6161
E-mail: service@csb-battery.com.tw

CSB BATTERY LOGISTICS (SHANGHAI) CO., LTD.
SHANGHAI OFFICE
Tel: +86-21-5046-1622, 5046-0833
Fax: +86-21-5064-3314

CSB BATTERY TECHNOLOGIES, INC
USA OFFICE
Tel: +1-817-244-7777/1-8003 CSBUSA(272872)
Fax: +1-817-244-4445
E-mail: csb@csb-battery.com

CSB BATTERY LOGISTICS (SHANGHAI) CO., LTD.
BEIJING OFFICE
Tel: +86-10-6597-8060, 6597-8070
Fax: +86-10-6597-8050
E-mail: chinastls@csb-battery.com

CSB BATTERY OF NETHERLANDS B.V
NETHERLANDS OFFICE
Tel: +31(0) 180 418 140
Fax: +31(0) 180 418 327
E-mail: eurosales@csb-battery.com

CSB BATTERY LOGISTICS (SHANGHAI) CO., LTD.
SHENZHEN OFFICE
Tel: +86-755-88316356 88316488 88316396
Fax: +86-755-88316548
E-mail: she@csb-battery.com