



# HC 1221W

## 12V 21W

HC 1221W is specially designed for high efficient discharge application. Its invisible terminal can be inserted PC board directly. HC series battery can serve more than 260 cycles at 100% discharge in cycle service, or three to five years in standby service.



### Specification

<b>Cells Per Unit</b>	6
<b>Voltage Per Unit</b>	12
<b>Capacity</b>	21W @ 15 minute-rate to 1.67V per cell @25 °C (77°F)
<b>Weight</b>	Approx. 1.90kg(4.2 lbs)
<b>Maximum Discharge Current</b>	60A(5sec)
<b>Internal Resistance</b>	Approx. 21mΩ
<b>Operating Temperature Range</b>	Discharge: -15°C~50°C (5°F~122°F) Charge: -15~40°C (5°F~104°F) Storage: -15°C~40°C (5°F~104°F)
<b>Nominal Operating Temperature Range</b>	25°C±3°C (77°F±5°F)
<b>Float Charging Voltage</b>	13.5 to 13.8 VDC/unit Average at 25°C (77°F)
<b>Recommended Maximum Charging</b>	2.1A
<b>Current Limit</b>	
<b>Equalization and Cycle Service</b>	14.4 to 15.0 VDC/unit Average at 25°C (77°F)
<b>Self Discharge</b>	CSB Batteries can be stored for more than 6 months at 25°C (77°F). Please charge batteries before using. For higher temperatures the time interval will be shorter.
<b>Terminal</b>	Faston Tab 187/250
<b>Container Material</b>	-ABS (UL94-HB)*Flammability resistance of UL94-V2 can be available upon request.



CSB-manufactured batteries are UL-recognized components under UL924 as well as ISO 9001 and ISO 14001 certified.

### Dimensions

unit: (MM)

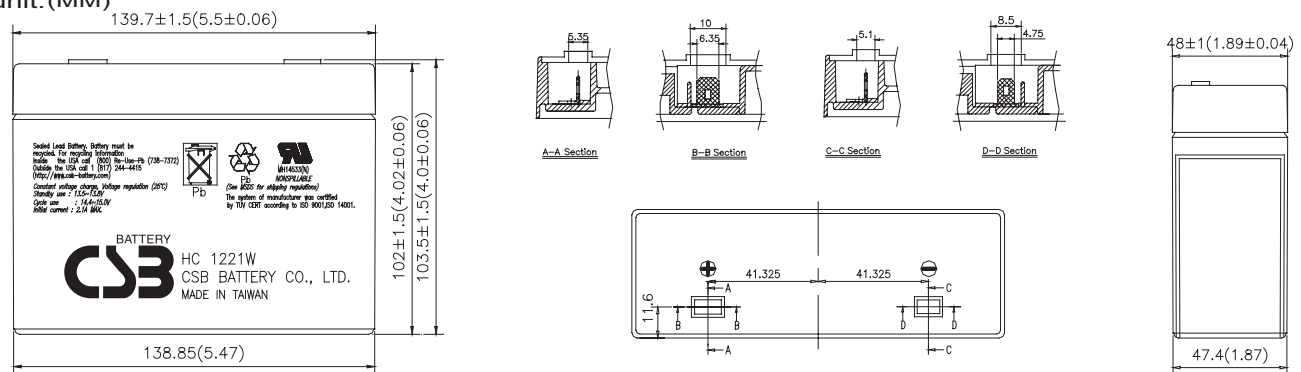

### Constant Current Discharge Characteristics Unit:A(25°C, 77°F)

F.V/Time	2MIN	4MIN	6MIN	8MIN	10MIN	15MIN	20MIN	30MIN	60MIN	90MIN
1.60V	46.42	31.17	24.42	20.33	16.42	12.33	10.67	7.18	4.02	2.83
1.67V	43.38	30.12	23.78	19.98	16.30	12.27	10.61	7.15	4.00	2.71
1.70V	42.08	29.67	23.50	19.83	16.25	12.25	10.58	7.13	3.99	2.66
1.75V	37.58	27.42	22.17	19.00	15.75	12.00	10.42	7.13	3.99	2.56
1.80V	33.08	25.17	20.83	18.17	15.25	11.75	10.25	7.12	3.98	2.46
1.85V	28.58	22.92	19.50	17.34	14.75	11.50	10.09	7.12	3.98	2.36

### Constant Power Discharge Characteristics Unit:W (25°C, 77°F)

F.V/Time	2MIN	4MIN	6MIN	8MIN	10MIN	15MIN	20MIN	30MIN	60MIN	90MIN
1.60V	557.00	374.00	293.00	244.00	197.00	148.00	128.00	86.10	48.20	33.90
1.67V	520.60	361.40	285.30	239.80	195.60	147.30	127.30	85.75	47.99	32.50
1.70V	505.00	356.00	282.00	238.00	195.00	147.00	127.00	85.60	47.90	31.90
1.75V	451.00	329.00	266.00	228.00	189.00	144.00	125.00	85.50	47.85	30.70
1.80V	397.00	302.00	250.00	218.00	183.00	141.00	123.00	85.40	47.80	29.50
1.85V	343.00	275.00	234.00	208.00	177.00	138.00	121.00	85.30	47.75	28.30

• All mentioned values are average values.

## Trickle (or Float) Service Life

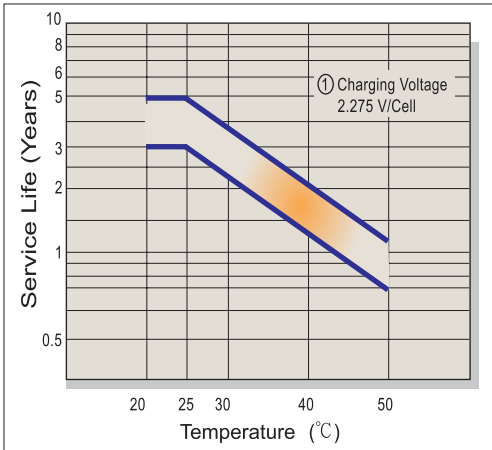

## Capacity Retention Characteristic

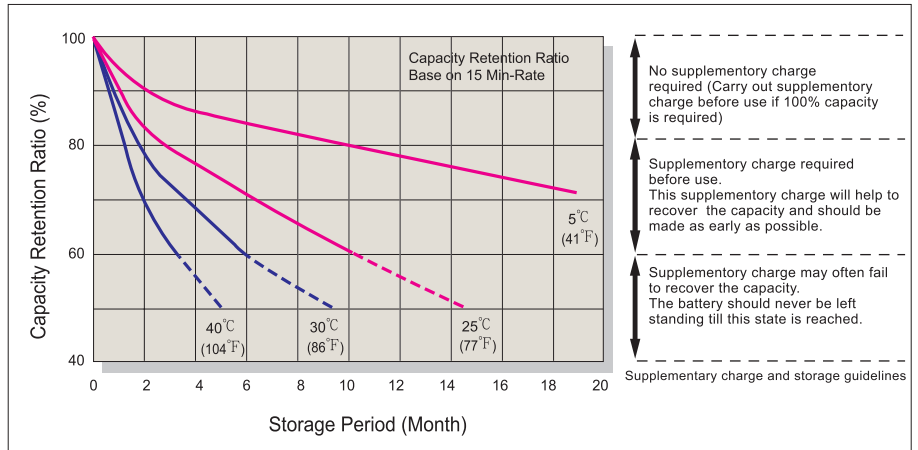

## Battery Voltage and Charge Time for Standby Use

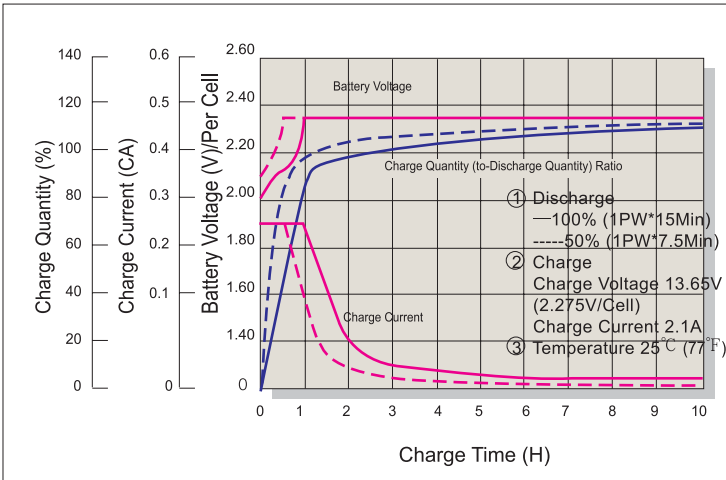

## Cycle Service Life

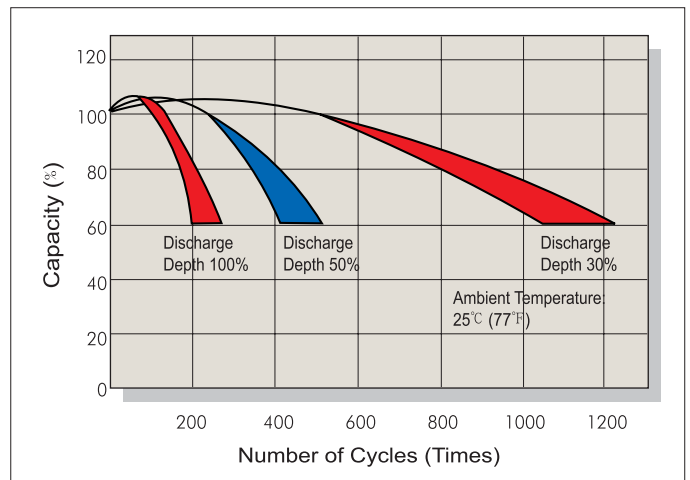

## Battery Voltage and Charge Time for Cycle Use

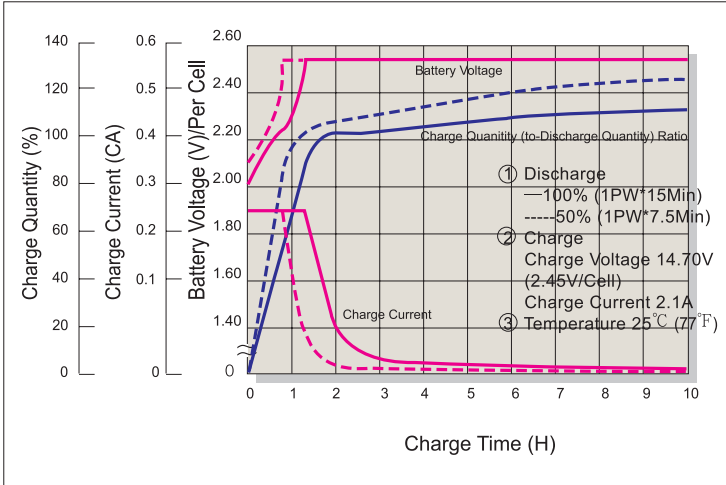

## Terminal Voltage (V) and Discharge Time (25°C 77°F)

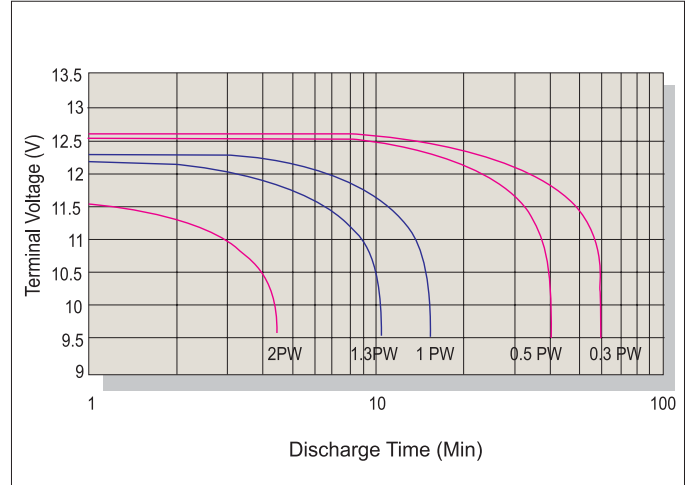

## Charging Procedures

Application	Charge Voltage (V/Cell)			Max. Charge Current
	Temperature	Set Point	Allowable Range	
Cycle Use	25°C (77°F)	2.45	2.40-2.50	0.3C
Standby	25°C (77°F)	2.275	2.25-2.30	

## Discharge Current VS. Discharge Voltage

Final Discharge Voltage V/Cell	1.75	1.70	1.55	1.30
Discharge Current (A)	0.2C > (A)	0.2C < (A) < 0.5C	0.5C < (A) < 1.0C	(A) > 1.0C

Sales Office URL: [WWW.CSB-BATTERY.COM](http://WWW.CSB-BATTERY.COM)

**CSB BATTERY CO., LTD.**  
TAIWAN OFFICE  
Tel: +886-2-8751-5000  
Fax: +886-2-8751-6161  
E-mail: [service@csb-battery.com.tw](mailto:service@csb-battery.com.tw)

**CSB BATTERY LOGISTICS (SHANGHAI) CO., LTD.**  
SHANGHAI OFFICE  
Tel: +86-21-5046-1622, 5046-0833  
Fax: +86-21-5064-3314

**CSB BATTERY TECHNOLOGIES, INC**  
USA OFFICE  
Tel: +1-817-244-7777/1-8003 CSBUSA(272872)  
Fax: +1-817-244-4445  
E-mail: [csb@csb-battery.com](mailto:csb@csb-battery.com)

**CSB BATTERY LOGISTICS (SHANGHAI) CO., LTD.**  
BEIJING OFFICE  
Tel: +86-10-6597-8060, 6597-8070  
Fax: +86-10-6597-8050  
E-mail: [chinastls@csb-battery.com](mailto:chinastls@csb-battery.com)

**CSB BATTERY OF NETHERLANDS B.V**  
NETHERLANDS OFFICE  
Tel: +31(0) 180 418 140  
Fax: +31(0) 180 418 327  
E-mail: [eurosales@csb-battery.com](mailto:eurosales@csb-battery.com)

**CSB BATTERY LOGISTICS (SHANGHAI) CO., LTD.**  
SHENZHEN OFFICE  
Tel: +86-755-88316356 88316488 88316396  
Fax: +86-755-88316548  
E-mail: [she@csb-battery.com](mailto:she@csb-battery.com)