



# GP 121000

## 12V 100.0Ah

GP 121000 is a general purpose battery with 3-5 years in standby service or more than 260 cycles at 100% discharge in cycle service. As with all CSB batteries, all are rechargeable, highly efficient, leak proof and maintenance free.



### Specification

<b>Cells Per Unit</b>	6
<b>Voltage Per Unit</b>	12
<b>Capacity</b>	100Ah @ 20hr-rate to 1.75V per cell @25 °C(77°F)
<b>Weight</b>	Approx. 31.2kg(68.6 lbs)
<b>Maximum Discharge Current</b>	500A(5sec)
<b>Internal Resistance</b>	Approx. 4mΩ
<b>Operating Temperature Range</b>	Discharge: -15°C~50°C (5°F~122°F) Charge: -15~40°C (5°F~104°F) Storage: -15°C~40°C (5°F~104°F)
<b>Nominal Operating Temperature Range</b>	25°C±3°C(77°F±5°F)
<b>Float Charging Voltage</b>	13.5 to 13.8 VDC/unit Average at 25°C(77°F)
<b>Recommended Maximum Charging Current Limit</b>	30A
<b>Equalization and Cycle Service</b>	14.4 to 15.0 VDC/unit Average at 25°C(77°F)
<b>Self Discharge</b>	CSB Batteries can be stored for more than 6 months at 25°C(77°F). Please charge batteries before using. For higher temperatures the time interval will be shorter.
<b>Terminal</b>	Bolt & Nut
<b>Container Material</b>	-Polypropylene (94-HB)



CSB-manufactured batteries are UL-recognized components under UL924 and UL1989. CSB is also certified by ISO 9001 and ISO 14001.

### Dimensions

unit: (MM)

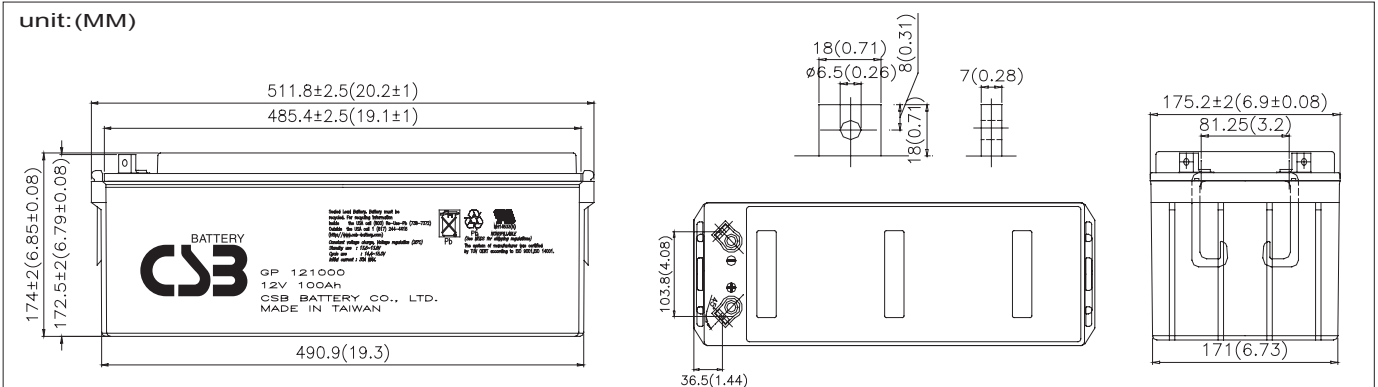

### Constant Current Discharge Characteristics Unit:A (25°C,77°F)

F.V/Time	5MIN	10MIN	15MIN	30MIN	1HR	2HR	3HR	4HR	5HR	8HR	10HR	20HR
1.60V	374	268	195	121	70.1	39.9	29.0	22.7	18.6	12.3	10.1	5.40
1.67V	364	255	191	119	69.8	39.6	28.9	22.6	18.5	12.2	10.0	5.30
1.70V	343	246	188	118	69.2	39.3	28.7	22.5	18.4	12.1	9.90	5.20
1.75V	308	227	179	115	68.5	39.0	28.5	22.3	18.2	12.0	9.80	5.10
1.80V	278	207	165	110	66.9	38.3	27.8	21.8	17.9	11.8	9.70	5.00
1.85V	242	185	148	103	63.5	36.6	26.5	20.7	17.1	11.3	9.40	4.80

### Constant Power Discharge Characteristics Unit:W (25°C,77°F)

F.V/Time	5MIN	10MIN	15MIN	30MIN	1HR	2HR	3HR	4HR	5HR	8HR	10HR	20HR
1.60V	4023	2942	2166	1366	802	459	335	263	216	143	117	61.1
1.67V	3941	2810	2121	1349	798	457	334	262	215	142	116	60.5
1.70V	3720	2716	2092	1333	792	453	332	261	214	141	115	60.0
1.75V	3350	2510	1995	1303	784	449	330	259	212	140	114	59.5
1.80V	3013	2279	1833	1244	765	442	322	252	208	137	113	58.9
1.85V	2601	2024	1637	1165	725	422	306	240	198	132	109	56.6

• All mentioned values are average values.

### Trickle (or Float) Service Life

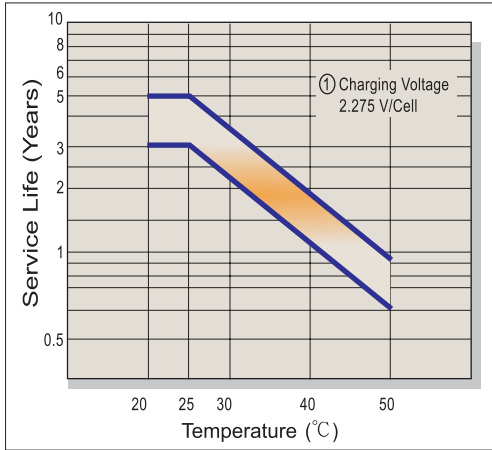

### Capacity Retention Characteristic

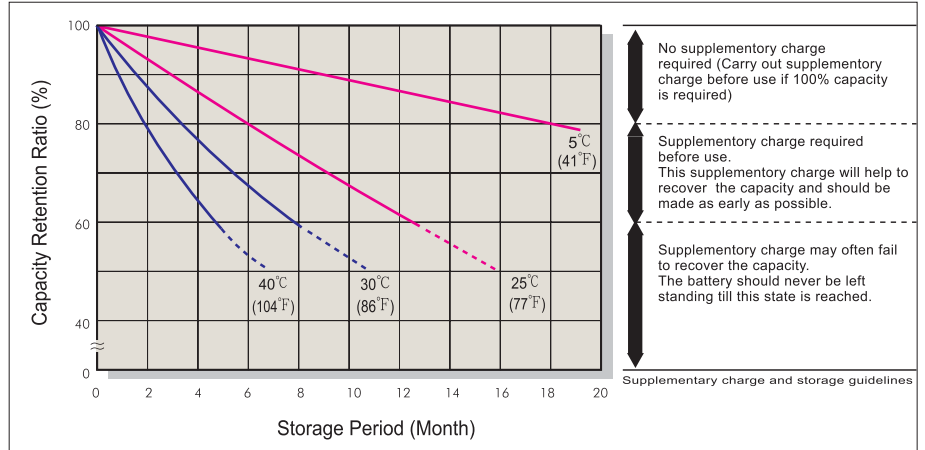

### Battery Voltage and Charge Time for Standby Use

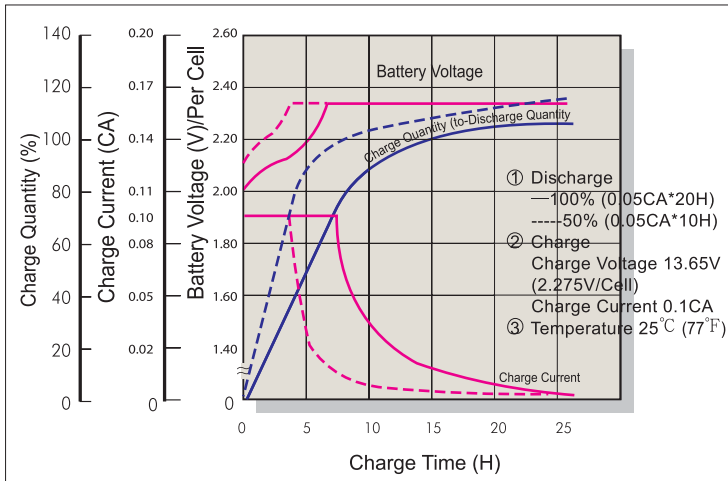

### Cycle Service Life

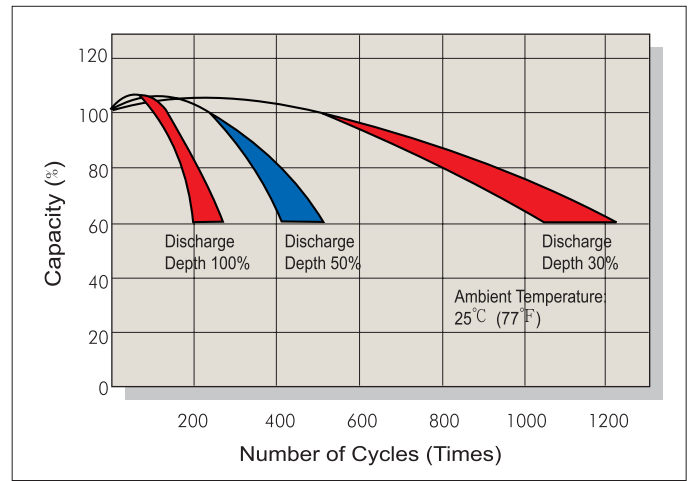

### Battery Voltage and Charge Time for Cycle Use

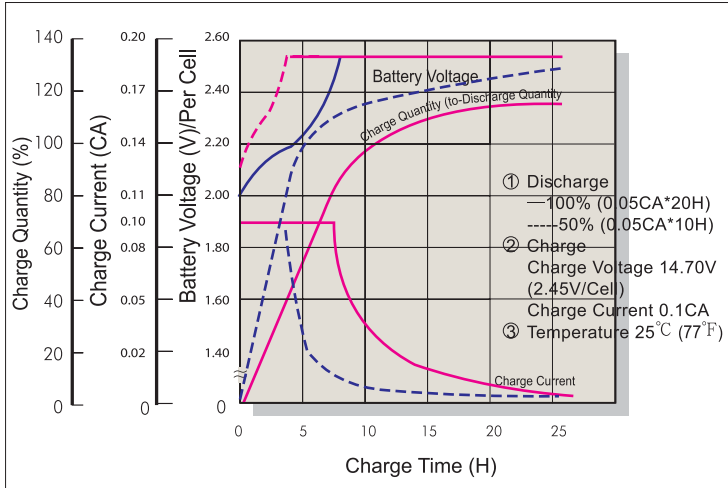

### Terminal Voltage (V) and Discharge Time (25°C 77°F)

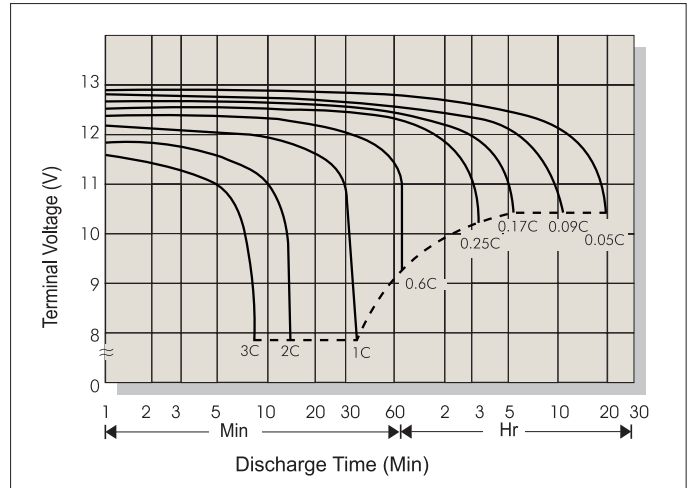

### Charging Procedures

Application	Charge Voltage (V/Cell)			Max. Charge Current
	Temperature	Set Point	Allowable Range	
Cycle Use	25°C (77°F)	2.45	2.40~2.50	0.3C
Standby	25°C (77°F)	2.275	2.25~2.30	

### Discharge Current VS. Discharge Voltage

Final Discharge Voltage V/Cell	1.75	1.70	1.55	1.30
Discharge Current (A)	0.2C > (A)	0.2C < (A) < 0.5C	0.5C < (A) < 1.0C	(A) > 1.0C

Sales Office URL: [WWW.CSB-BATTERY.COM](http://WWW.CSB-BATTERY.COM)

**CSB BATTERY CO., LTD.**  
TAIWAN OFFICE  
Tel: +886-2-8751-5000  
Fax: +886-2-8751-6161  
E-mail: [service@csb-battery.com.tw](mailto:service@csb-battery.com.tw)

**CSB BATTERY LOGISTICS (SHANGHAI) CO., LTD.**  
SHANGHAI OFFICE  
Tel: +86-21-5046-1622, 5046-0833  
Fax: +86-21-5064-3314

**CSB BATTERY TECHNOLOGIES, INC**  
USA OFFICE  
Tel: +1-817-244-7777/1-8003 CSBUSA(272872)  
Tel: +1-817-244-4445  
E-mail: [csb@csb-battery.com](mailto:csb@csb-battery.com)

**CSB BATTERY LOGISTICS (SHANGHAI) CO., LTD.**  
BEIJING OFFICE  
Tel: +86-10-6597-8060, 6597-8070  
Fax: +86-10-6597-8050  
E-mail: [chinastls@csb-battery.com](mailto:chinastls@csb-battery.com)

**CSB BATTERY OF NETHERLANDS B.V**  
NETHERLANDS OFFICE  
Tel: +31(0) 180 418 140  
Fax: +31(0) 180 418 327  
E-mail: [eurosales@csb-battery.com](mailto:eurosales@csb-battery.com)

**CSB BATTERY LOGISTICS (SHANGHAI) CO., LTD.**  
SHENZHEN OFFICE  
Tel: +86-755-88316356 88316488 88316396  
Fax: +86-755-88316548  
E-mail: [she@csb-battery.com](mailto:she@csb-battery.com)