

EVX 12750

12V 75.0Ah

EVX 12750 is designed specially for electric vehicles, such as electric golf cart, electric wheelchair, mower, dust collector...etc. It has high cycling life, high efficiency and long service life.



Specification

Cells Per Unit	6
Voltage Per Unit	12
Capacity	75Ah @ 20hr-rate to 1.75V per cell @25 °C (77°F)
Weight	Approx. 26.8kg(58.96 lbs)
Maximum Discharge Current	500A(5sec)
Internal Resistance	Approx. 8mΩ
Operating Temperature Range	Discharge: -15°C~50°C (5°F~122°F) Charge: -15~40°C (5°F~104°F) Storage: -15°C~40°C (5°F~104°F)
Nominal Operating Temperature Range	25°C±3°C(77°F±5°F)
Float Charging Voltage	13.5 to 13.8 VDC/unit Average at 25°C(77°F)
Recommended Maximum Charging	21.0A
Current Limit	
Equalization and Cycle Service	14.4 to 15.0 VDC/unit Average at 25°C(77°F)
Self Discharge	CSB Batteries can be stored for more than 6 months at 25°C(77°F). Please charge batteries before using. For higher temperatures the time interval will be shorter.
Terminal	Bolt & Nut
Container Material	-ABS (UL94-HB)*Flammability resistance of UL94-V0 can be available upon request.

MH14533(N)

TÜV CERT
ISO9001
No :041005117

RWTV
ISO 14001
NO.UM 1-12-0045

CSB-manufactured batteries are UL-recognized components under UL924 and UL1989. CSB is also certified by ISO 9001 and ISO 14001.

Dimensions

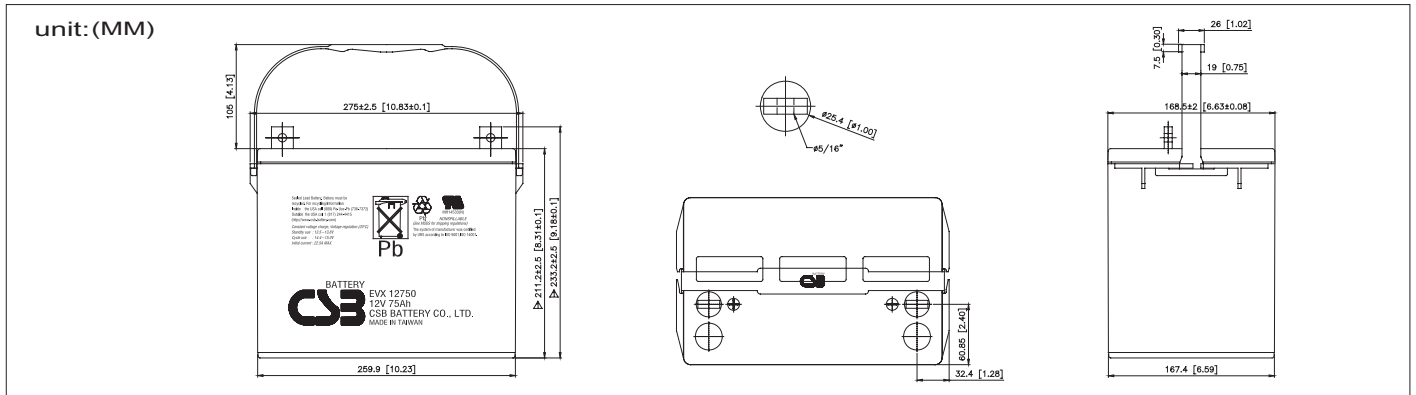

Constant Current Discharge Characteristics Unit:A (25°C ,77°F)

F.V/Time	30MIN	60MIN	90MIN	2HR	3HR	4HR	5HR	8HR	10HR	20HR
1.60V	83.20	49.30	35.70	28.10	19.90	15.60	12.80	8.35	6.82	3.84
1.67V	82.50	48.90	35.30	27.70	19.70	15.40	12.70	8.23	6.72	3.79
1.70V	82.00	48.50	35.00	27.50	19.60	15.30	12.60	8.20	6.69	3.77
1.75V	80.80	48.20	34.60	27.30	19.40	15.20	12.50	8.16	6.66	3.75
1.80V	78.00	47.00	33.90	26.80	19.20	15.00	12.30	8.05	6.57	3.72
1.85V	73.30	44.40	32.50	25.70	18.60	14.60	12.00	7.89	6.47	3.68

Constant Power Discharge Characteristics Unit:W (25°C ,77°F)

F.V/Time	30MIN	60MIN	90MIN	2HR	3HR	4HR	5HR	8HR	10HR	20HR
1.60V	924.00	538.00	392.00	313.00	226.00	177.00	146.00	95.20	77.50	41.40
1.67V	915.00	531.00	387.00	308.00	221.00	174.00	143.00	94.10	76.90	41.20
1.70V	914.00	527.00	383.00	304.00	219.00	172.00	142.00	93.70	76.70	41.00
1.75V	903.00	520.00	378.00	300.00	216.00	170.00	140.00	92.80	76.00	40.70
1.80V	875.00	510.00	372.00	297.00	214.00	168.00	139.00	92.00	75.50	40.60
1.85V	813.00	484.00	359.00	288.00	210.00	165.00	137.00	90.30	74.20	39.80

• All mentioned values are average values.

Trickle (or Float) Service Life

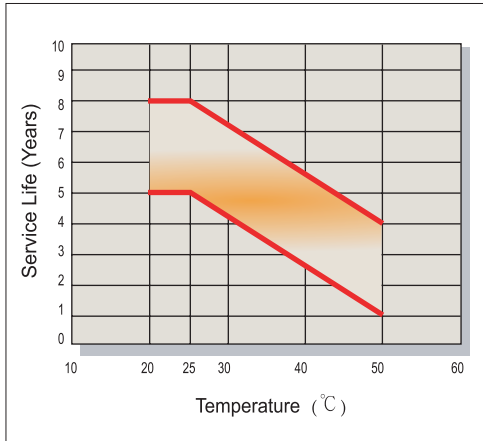

Capacity Retention Characteristic

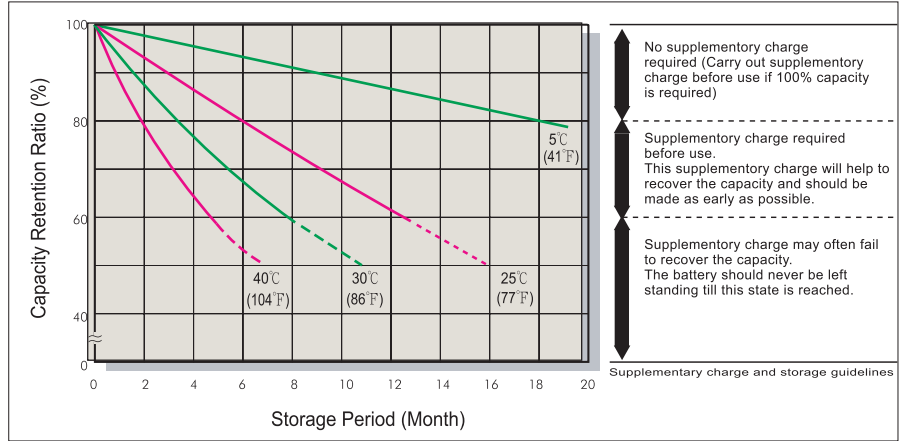

No supplementary charge required (Carry out supplementary charge before use if 100% capacity is required)

Supplementary charge required before use. This supplementary charge will help to recover the capacity and should be made as early as possible.

Supplementary charge may often fail to recover the capacity. The battery should never be left standing till this state is reached.

Supplementary charge and storage guidelines

Battery Voltage and Charge Time for Standby Use

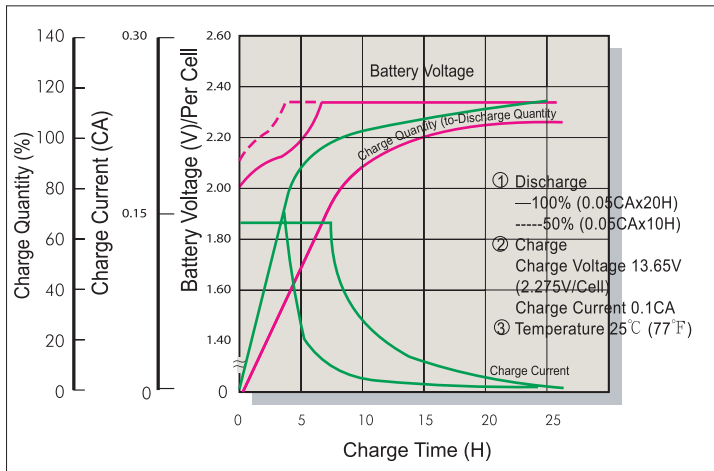

GP & EVX Series Cycle Service Life

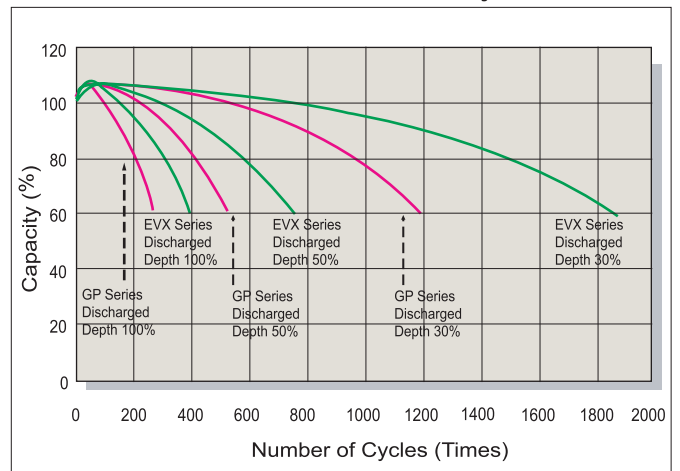

Battery Voltage and Charge Time for Cycle Use

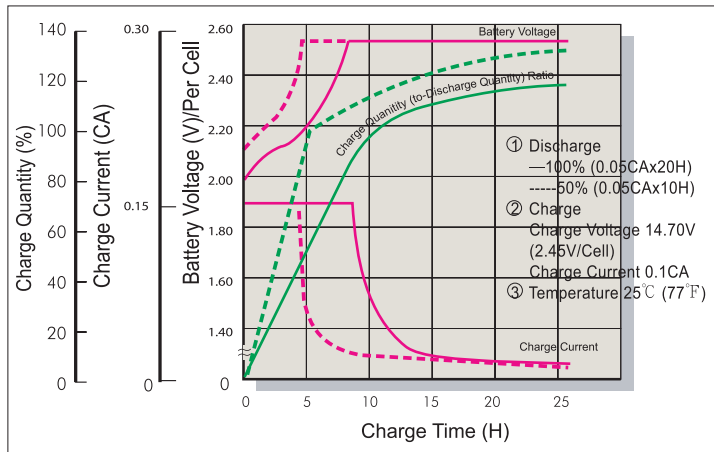

Terminal Voltage (V) and Discharge Time (25°C 77°F)

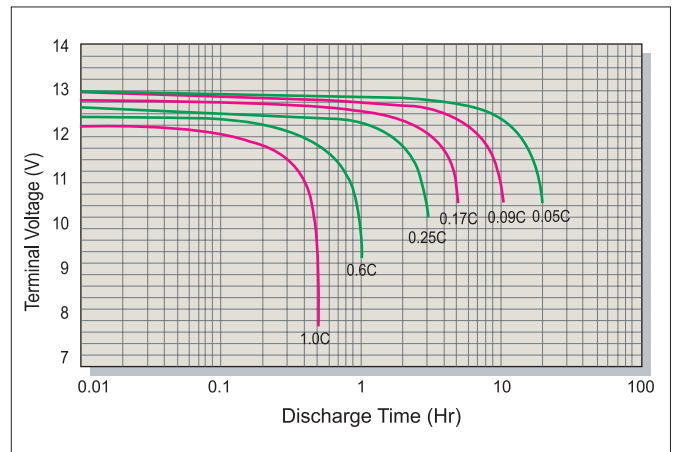

Charging Procedures

Application	Charge Voltage (V/Cell)			Max. Charge Current
	Temperature	Set Point	Allowable Range	
Cycle Use	25°C (77°F)	2.45	2.40~2.50	0.3C
Standby	25°C (77°F)	2.275	2.25~2.30	

Discharge Current VS. Discharge Voltage

Final Discharge Voltage V/Cell	1.75	1.70	1.55	1.30
Discharge Current (A)	0.2C>(A)	0.2C<(A)<0.5C	0.5C<(A)<1.0C	(A)>1.0C

Sales Office URL: WWW.CSB-BATTERY.COM

CSB BATTERY CO., LTD.
TAIWAN OFFICE
Tel: +886-2-8751-5000
Fax: +886-2-8751-6161
E-mail: service@csb-battery.com.tw

CSB BATTERY LOGISTICS (SHANGHAI) CO., LTD.
SHANGHAI OFFICE
Tel: +86-21-5046-1622, 5046-0833
Fax: +86-21-5064-3314

CSB BATTERY TECHNOLOGIES, INC
USA OFFICE
Tel: +1-817-244-7777/1-8003 CSBUSA(272872)
Tel: +1-817-244-4445
E-mail: csb@csb-battery.com

CSB BATTERY LOGISTICS (SHANGHAI) CO., LTD.
BEIJING OFFICE
Tel: +86-10-6597-8060, 6597-8070
Fax: +86-10-6597-8050
E-mail: chinastls@csb-battery.com

CSB BATTERY OF NETHERLANDS B.V
NETHERLANDS OFFICE
Tel: +31(0) 180 418 140
Fax: +31(0) 180 418 327
E-mail: eurosales@csb-battery.com

CSB BATTERY LOGISTICS (SHANGHAI) CO., LTD.
SHENZHEN OFFICE
Tel: +86-755-88316356 88316488 88316396
Fax: +86-755-88316548
E-mail: she@csb-battery.com