



EVX 12340

12V 34.0Ah

EVX 12340 is designed specially for electric vehicles, such as electric golf cart, electric wheelchair, mower, dust collector...etc. It has high cycling life, high efficiency and long service life.

Specification

Cells Per Unit	6
Voltage Per Unit	12
Capacity	34Ah @ 20hr-rate to 1.75V per cell @25 °C (77°F)
Weight	Approx. 11.74kg(25.8 lbs)
Maximum Discharge Current	400A(5sec)
Internal Resistance	Approx. 8.5mΩ
Operating Temperature Range	Discharge: -15°C~50°C (5°F~122°F) Charge: -15~40°C (5°F~104°F) Storage: -15°C~40°C (5°F~104°F)
Nominal Operating Temperature Range	25°C±3°C(77°F±5°F)
Float Charging Voltage	13.5 to 13.8 VDC/unit Average at 25°C(77°F)
Recommended Maximum Charging Current Limit	10.2A
Equalization and Cycle Service	14.4 to 15.0 VDC/unit Average at 25°C(77°F)
Self Discharge	CSB Batteries can be stored for more than 6 months at 25°C(77°F). Please charge batteries before using. For higher temperatures the time interval will be shorter.
Terminal	Bolt & Nut
Container Material	-ABS (UL94-HB)*Flammability resistance of UL94-V0 can be available upon request.

MH14533(N)

TÜV CERT
ISO9001
No.:041005117

RWTV
ISO 14001
NO.UM 1-12-0045

CSB-manufactured batteries are UL-recognized components under UL924 and UL1989. CSB is also certified by ISO 9001 and ISO 14001.

Dimensions

unit: (MM)

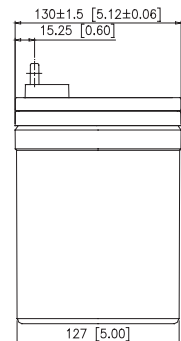
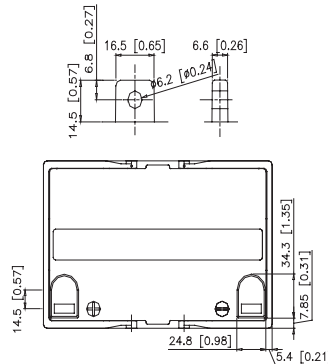
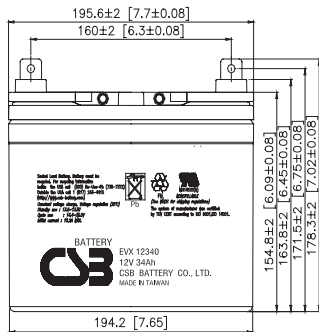

Constant Current Discharge Characteristics Unit:A (25°C,77°F)

F.V/Time	30MIN	60MIN	90MIN	2HR	3HR	4HR	5HR	8HR	10HR	20HR
1.60V	34.50	20.17	14.58	12.25	8.25	6.53	5.39	3.63	3.00	1.63
1.67V	33.28	19.70	14.41	12.08	8.19	6.52	5.34	3.55	2.91	1.54
1.70V	32.75	19.50	14.33	12.00	8.17	6.51	5.32	3.51	2.87	1.50
1.75V	31.79	19.09	14.04	11.79	8.05	6.40	5.24	3.46	2.83	1.48
1.80V	30.83	18.67	13.75	11.58	7.93	6.29	5.15	3.41	2.78	1.45
1.85V	29.87	18.26	13.46	11.37	7.81	6.18	5.07	3.36	2.74	1.43

Constant Power Discharge Characteristics Unit:W (25°C,77°F)

F.V/Time	30MIN	60MIN	90MIN	2HR	3HR	4HR	5HR	8HR	10HR	20HR
1.60V	414.00	242.00	175.00	147.00	99.00	78.40	64.70	43.60	36.00	19.50
1.67V	399.30	236.40	172.90	144.90	98.30	78.19	64.07	42.55	34.88	18.45
1.70V	393.00	234.00	172.00	144.00	98.00	78.10	63.80	42.10	34.40	18.00
1.75V	381.50	229.00	168.50	141.50	96.55	76.80	62.80	41.50	33.90	17.70
1.80V	370.00	224.00	165.00	139.00	95.10	75.50	61.80	40.90	33.40	17.40
1.85V	358.50	219.00	161.50	136.50	93.65	74.20	60.80	40.30	32.90	17.10

• All mentioned values are average values.

Trickle (or Float) Service Life

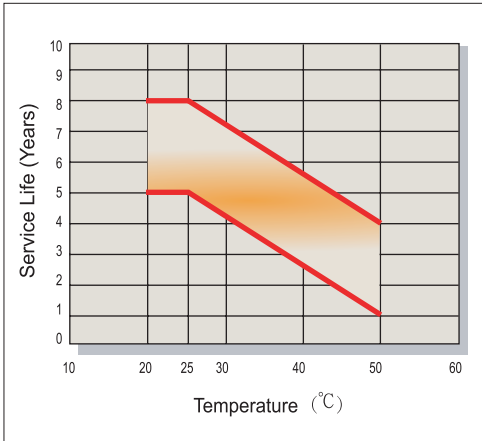

Capacity Retention Characteristic

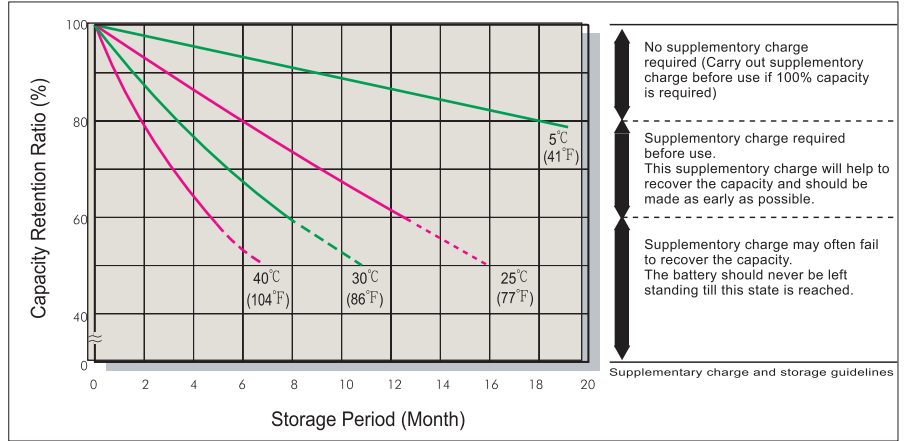

No supplementary charge required (Carry out supplementary charge before use if 100% capacity is required)

Supplementary charge required before use. This supplementary charge will help to recover the capacity and should be made as early as possible.

Supplementary charge may often fail to recover the capacity. The battery should never be left standing till this state is reached.

Supplementary charge and storage guidelines

Battery Voltage and Charge Time for Standby Use

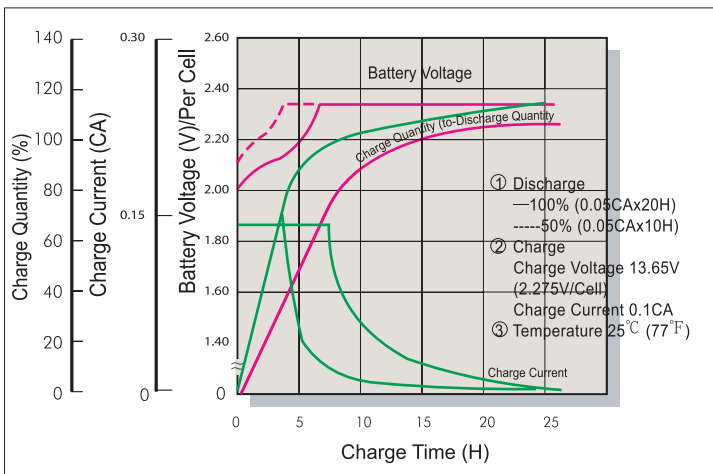

GP & EVX Series Cycle Service Life

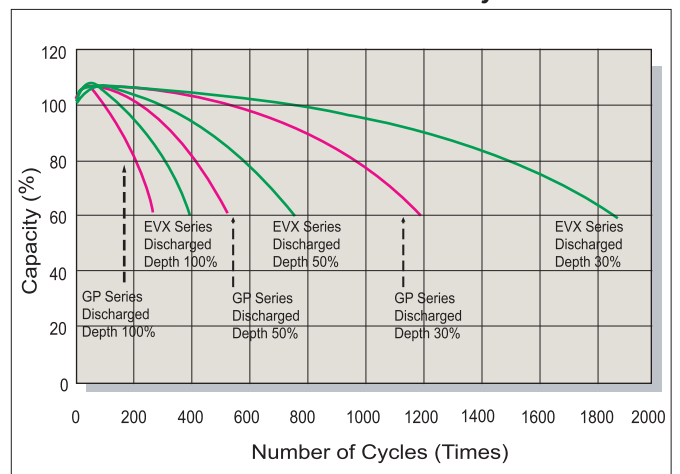

Battery Voltage and Charge Time for Cycle Use

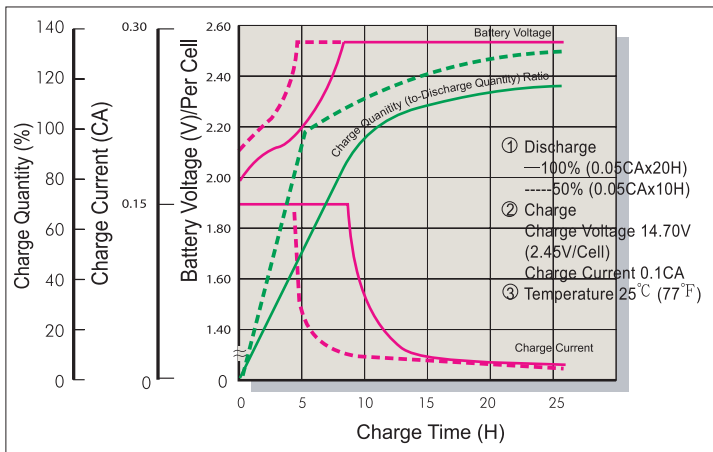

Terminal Voltage (V) and Discharge Time (25°C 77°F)

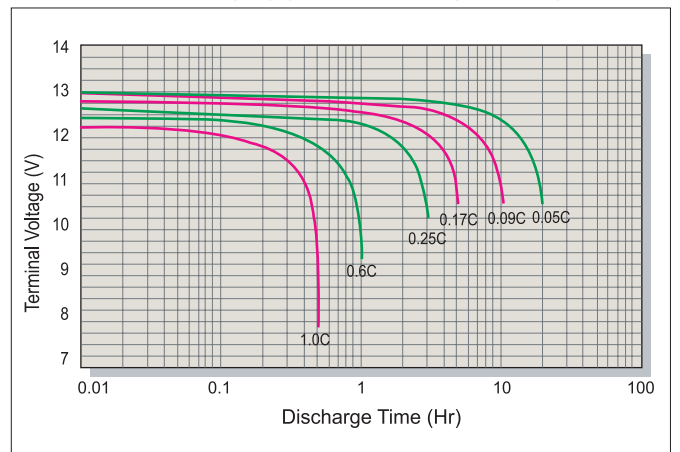

Charging Procedures

Application	Charge Voltage (V/Cell)			Max. Charge Current
	Temperature	Set Point	Allowable Range	
Cycle Use	25°C (77°F)	2.45	2.40~2.50	0.3C
Standby	25°C (77°F)	2.275	2.25~2.30	

Discharge Current VS. Discharge Voltage

Final Discharge Voltage V/Cell	1.75	1.70	1.55	1.30
Discharge Current (A)	0.2C>(A)	0.2C<(A)<0.5C	0.5C<(A)<1.0C	(A)>1.0C

Sales Office URL: WWW.CSB-BATTERY.COM

CSB BATTERY CO., LTD.
 TAIWAN OFFICE
 Tel: +886-2-8751-5000
 Fax: +886-2-8751-6161
 E-mail: service@csb-battery.com.tw

CSB BATTERY LOGISTICS (SHANGHAI) CO., LTD.
 SHANGHAI OFFICE
 Tel: +86-21-5046-1622, 5046-0833
 Fax: +86-21-5064-3314

CSB BATTERY TECHNOLOGIES, INC
 USA OFFICE
 Tel: +1-817-244-7777/1-8003 CSBUSA(272872)
 Fax: +1-817-244-4445
 E-mail: csb@csb-battery.com

CSB BATTERY LOGISTICS (SHANGHAI) CO., LTD.
 BEIJING OFFICE
 Tel: +86-10-6597-8060, 6597-8070
 Fax: +86-10-6597-8050
 E-mail: chinasl@csb-battery.com

CSB BATTERY OF NETHERLANDS B.V
 NETHERLANDS OFFICE
 Tel: +31(0) 180 418 140
 Fax: +31(0) 180 418 327
 E-mail: eurosales@csb-battery.com

CSB BATTERY LOGISTICS (SHANGHAI) CO., LTD.
 SHENZHEN OFFICE
 Tel: +86-755-88316356 88316488 88316396
 Fax: +86-755-88316548
 E-mail: she@csb-battery.com.tw