



# EVX 121000

## 12V 100.0Ah

EVX 121000 is designed specially for electric vehicles, such as electric golf cart, electric wheelchair, mower, dust collector...etc. It has high cycling life, high efficiency and long service life.



### Specification

<b>Cells Per Unit</b>	6
<b>Voltage Per Unit</b>	12
<b>Capacity</b>	100Ah @ 20hr-rate to 1.75V per cell @25 °C (77°F)
<b>Weight</b>	Approx. 35.5kg(78.1 lbs)
<b>Maximum Discharge Current</b>	500A(5sec)
<b>Internal Resistance</b>	Approx. 8mΩ
<b>Operating Temperature Range</b>	Discharge: -15°C~50°C (5°F~122°F) Charge: -15~40°C (5°F~104°F) Storage: -15°C~40°C (5°F~104°F)
<b>Nominal Operating Temperature Range</b>	25°C±3°C(77°F±5°F)
<b>Float Charging Voltage</b>	13.5 to 13.8 VDC/unit Average at 25°C(77°F)
<b>Recommended Maximum Charging</b>	30.0A
<b>Current Limit</b>	
<b>Equalization and Cycle Service</b>	14.4 to 15.0 VDC/unit Average at 25°C(77°F)
<b>Self Discharge</b>	CSB Batteries can be stored for more than 6 months at 25°C(77°F). Please charge batteries before using. For higher temperatures the time interval will be shorter.
<b>Terminal</b>	Bolt & Nut
<b>Container Material</b>	Polypropylene



CSB-manufactured batteries are UL-recognized components under UL924 and UL1989. CSB is also certified by ISO 9001 and ISO 14001.

### Dimensions

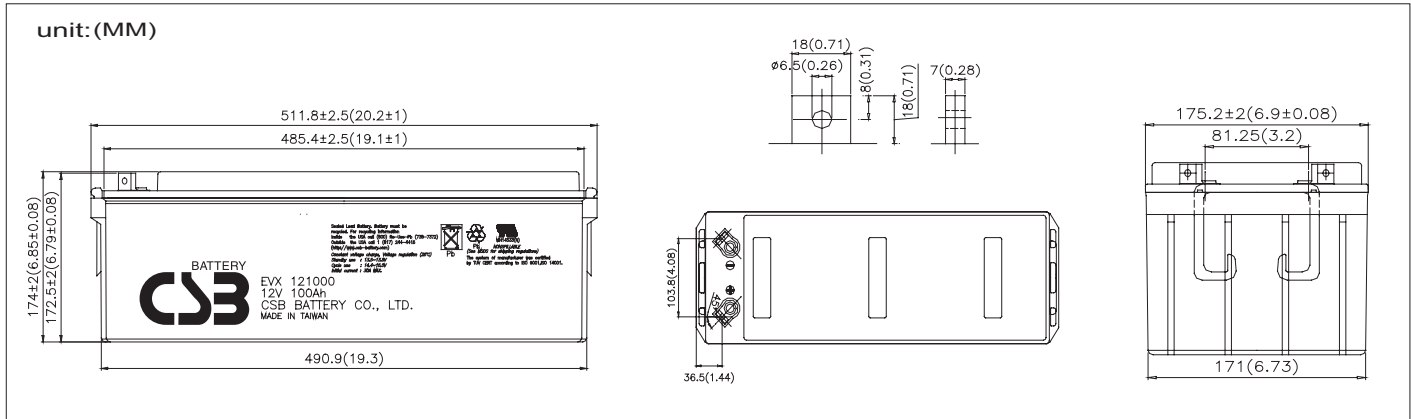

### Constant Current Discharge Characteristics Unit:A (25°C , 77°F)

F.V/Time	30MIN	60MIN	90MIN	2HR	3HR	4HR	5HR	8HR	10HR	20HR
1.60V	75.67	52.25	38.90	32.80	22.42	19.00	16.92	11.42	9.67	5.45
1.67V	73.40	50.44	37.43	31.47	21.55	18.23	16.22	10.95	9.32	5.23
1.70V	72.42	49.67	36.80	30.90	21.17	17.90	15.92	10.75	9.17	5.13
1.75V	70.38	48.21	35.85	30.10	20.55	17.33	15.46	10.42	8.88	4.97
1.80V	68.33	46.75	34.90	29.30	19.92	16.75	15.00	10.08	8.58	4.81
1.85V	66.29	45.29	33.95	28.50	19.30	16.18	14.54	9.75	8.29	4.65

### Constant Power Discharge Characteristics Unit:W (25°C , 77°F)

F.V/Time	30MIN	60MIN	90MIN	2HR	3HR	4HR	5HR	8HR	10HR	20HR
1.60V	908.00	627.00	467.00	393.00	269.00	228.00	203.00	137.00	116.00	65.40
1.67V	880.70	605.30	449.50	377.60	258.50	218.90	194.60	131.40	111.80	62.67
1.70V	869.00	596.00	442.00	371.00	254.00	215.00	191.00	129.00	110.00	61.50
1.75V	844.50	578.50	430.50	361.50	246.50	208.00	185.50	125.00	106.50	59.60
1.80V	820.00	561.00	419.00	352.00	239.00	201.00	180.00	121.00	103.00	57.70
1.85V	795.50	543.50	407.50	342.50	231.50	194.00	174.50	117.00	99.50	55.80

• All mentioned values are average values.

# EVX 121000 12V 100.0Ah



## Trickle (or Float) Service Life

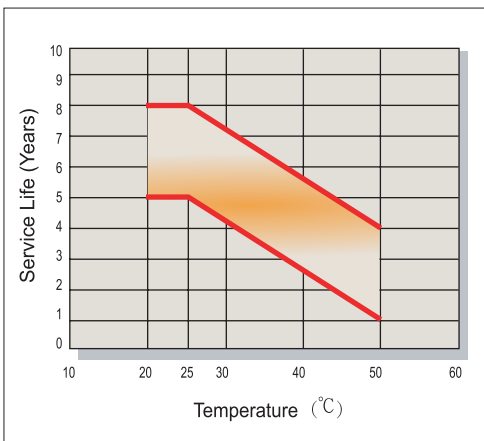

## Capacity Retention Characteristic

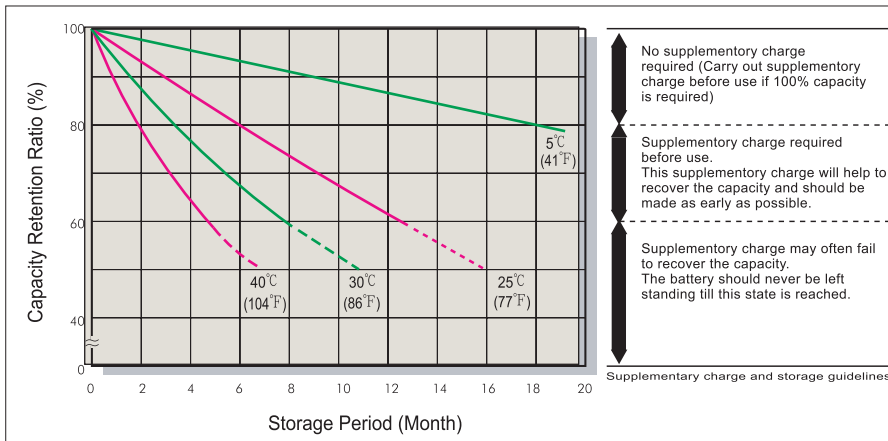

No supplementary charge required (Carry out supplementary charge before use if 100% capacity is required)

Supplementary charge required before use. This supplementary charge will help to recover the capacity and should be made as early as possible.

Supplementary charge may often fail to recover the capacity. The battery should never be left standing till this state is reached.

Supplementary charge and storage guidelines

## Battery Voltage and Charge Time for Standby Use

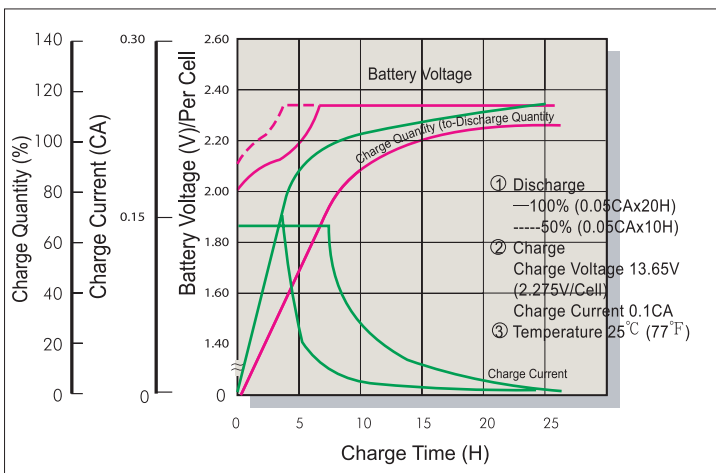

## GP & EVX Series Cycle Service Life

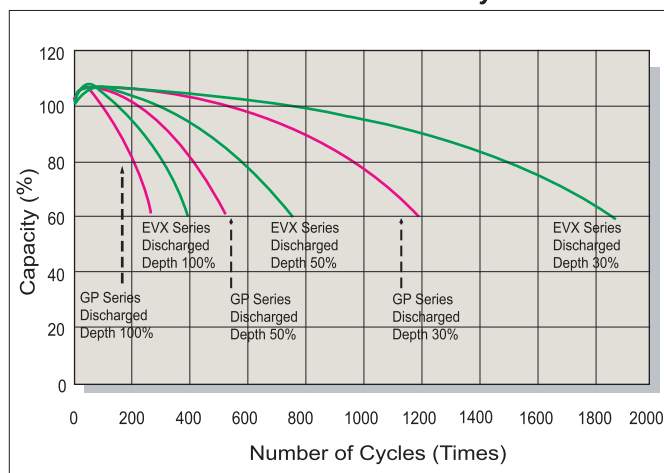

## Battery Voltage and Charge Time for Cycle Use

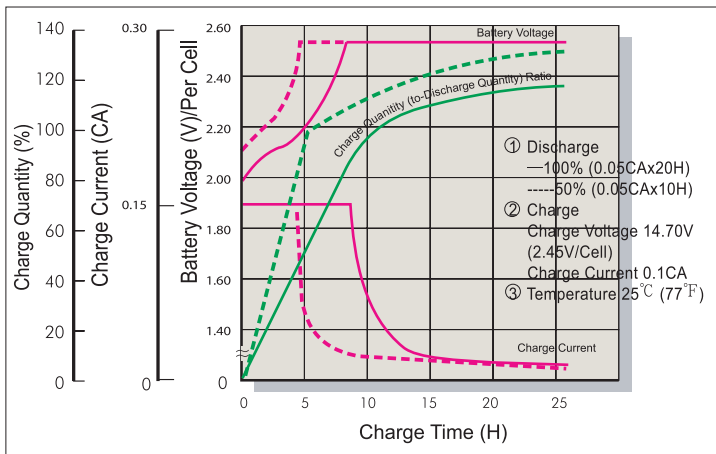

## Terminal Voltage (V) and Discharge Time (25°C 77°F)

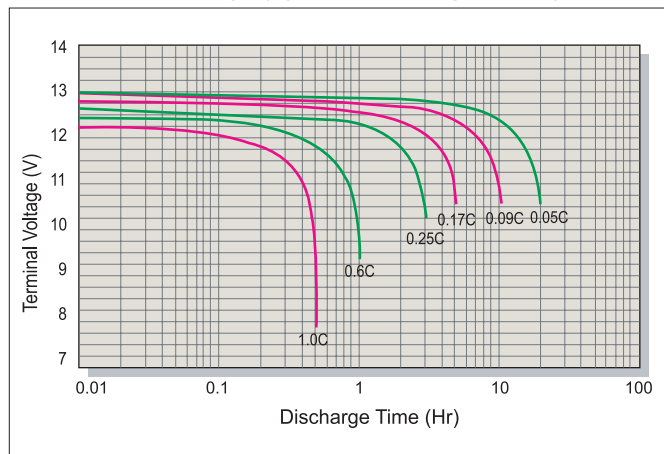

## Charging Procedures

Application	Charge Voltage (V/Cell)			Max. Charge Current
	Temperature	Set Point	Allowable Range	
Cycle Use	25°C (77°F)	2.45	2.40~2.50	0.3C
Standby	25°C (77°F)	2.275	2.25~2.30	

## Discharge Current VS. Discharge Voltage

Final Discharge Voltage V/Cell	1.75	1.70	1.55	1.30
Discharge Current (A)	0.2C>(A)	0.2C<(A)<0.5C	0.5C<(A)<1.0C	(A)>1.0C

Sales Office URL: [WWW.CSB-BATTERY.COM](http://WWW.CSB-BATTERY.COM)

CSB BATTERY CO., LTD.  
 TAIWAN OFFICE  
 Tel: +886-2-8751-5000  
 Fax: +886-2-8751-6161  
 E-mail: service@csb-battery.com.tw

CSB BATTERY LOGISTICS (SHANGHAI) CO., LTD.  
 SHANGHAI OFFICE  
 Tel: +86-21-5046-1622, 5046-0833  
 Fax: +86-21-5064-3314

CSB BATTERY TECHNOLOGIES, INC  
 USA OFFICE  
 Tel: +1-817-244-7777/1-8003 CSBUSA(272872)  
 Fax: +1-817-244-4445  
 E-mail: csb@csb-battery.com

CSB BATTERY LOGISTICS (SHANGHAI) CO., LTD.  
 BEIJING OFFICE  
 Tel: +86-10-6597-8060, 6597-8070  
 Fax: +86-10-6597-8050  
 E-mail: chinastls@csb-battery.com

CSB BATTERY OF NETHERLANDS B.V  
 NETHERLANDS OFFICE  
 Tel: +31(0) 180 418 140  
 Fax: +31(0) 180 418 327  
 E-mail: eurosales@csb-battery.com

CSB BATTERY LOGISTICS (SHANGHAI) CO., LTD.  
 SHENZHEN OFFICE  
 Tel: +86-755-88316356 88316488 88316396  
 Fax: +86-755-88316548  
 E-mail: she@csb-battery.com.tw