



TX90 Isolated Online UPS

1000VA, 2000VA, 3000VA, 5000VA Models

User & Installation Manual

Table of Contents

Important Safety Warning.....	4
Transportation.....	4
Preparation.....	4
Installation.....	4
Operation.....	4
Installation And Setup.....	6
Rear Panel View.....	6
Setup the UPS.....	8
Operations.....	10
Button Operation.....	10
LCD Panel.....	11
Audible Alarm.....	12
LCD Display Wordings Index.....	12
UPS Setting.....	13
Operating Mode Description.....	17
Faults Reference Code.....	18
Warning Indicator.....	18
Troubleshooting.....	19
Storage And Maintenance Operation.....	21
Specifications.....	22
Obtaining Service.....	23
Xtreme Power Conversion Limited Warranty.....	24
Xtreme Power Conversion Load Protection Policy.....	25

Important Safety Warning

Please comply with all warnings and operating instructions in this manual strictly. Save this manual properly and read carefully the following instructions before installing the unit. Do not operate this unit before reading through all safety information and operating instructions carefully.

Transportation

- Please transport the UPS system only in the original package to protect against shock and impact.

Preparation

- Condensation may occur if the UPS system is moved directly from cold to warm environment. The UPS system must be absolutely dry before being installed. Please allow at least two hours for the UPS system to acclimate the environment.
 - Do not install the UPS system near water or in moist environments.
- Do not install the UPS system where it would be exposed to direct sunlight or near heater.
- Do not block ventilation holes in the UPS housing.

Installation

- Do not connect appliances or devices which would overload the UPS system to the UPS output sockets.
 - Place cables in such a way that no one can step on or trip over them.
 - The UPS can be operated by any individuals with no previous experience.
- Connect the UPS system only to an earthed shockproof outlet which must be easily accessible and close to the UPS system.
- Please use only VDE-tested, CE-marked mains cable (e.g. the mains cable of your computer) to connect the UPS system to the building wiring outlet (shockproof outlet).
- Please use only VDE-tested, CE-marked power cables to connect the loads to the UPS system.
- When installing the equipment, it should ensure that the sum of the leakage current of the UPS and the connected devices does not exceed 3.5mA.

Operation

- Do not disconnect the mains cable on the UPS system or the building wiring outlet (shockproof socket outlet) during operations since this would cancel the protective earthing of the UPS system and of all connected loads.
- The UPS system features its own, internal current source (batteries). The UPS output sockets or output terminals block may be electrically live even if the UPS system is not connected to the building wiring outlet.
 - In order to fully disconnect the UPS system, first press the OFF/Enter button to disconnect the mains.
 - Prevent no fluids or other foreign objects from inside of the UPS system.

Maintenance, Service, and Faults

- The UPS system operates with hazardous voltages. Repairs may be carried out only by qualified maintenance personnel.
- **Caution** - risk of electric shock. Even after the unit is disconnected from the mains (building wiring outlet), components inside the UPS system are still connected to the battery and electrically live and dangerous.
- Before carrying out any kind of service and/or maintenance, disconnect the batteries and verify that no

current is present and no hazardous voltage exists in the terminals of high capability capacitor such as BUS-capacitors.

- Only persons are adequately familiar with batteries and with the required precautionary measures may replace batteries and supervise operations. Unauthorized persons must be kept well away from the batteries.
- **Caution** - risk of electric shock. The battery circuit is not isolated from the input voltage. Hazardous voltages may occur between the battery terminals and the ground. Before touching, please verify that no voltage is present!
- Batteries may cause electric shock and have a high short-circuit current. Please take the precautionary measures specified below and any other measures necessary when working with batteries:
 - o Remove wristwatches, rings and other metal objects
 - o Use only tools with insulated grips and handles.
- When changing batteries, install the same number and same type of batteries.
- Do not attempt to dispose of batteries by burning them. This could cause battery explosion.
- Do not open or destroy batteries. Escaping electrolyte can cause injury to the skin and eyes. It may be toxic.
- Please replace the fuse only with the same type and amperage in order to avoid fire hazards.
- Do not dismantle the UPS system.

Installation And Setup

Note: Before installation, please inspect the unit. Be sure that nothing inside the package is damaged. Please keep the original package in a safe place for future use.

Rear Panel View



TX90-1000



TX90i-1000



TX90-2000



TX90i-2000



TX90-3000



TX90i-3000



TX90i-5000

Setup the UPS

Step 1: UPS input connection

Plug the UPS into a two-pole, three-wire, grounded receptacle only. Avoid using extension cords (The long run model should be connected well the proper capacity of battery with the ups).

Step 2: UPS output connection

Simply plug devices to output sockets. During power failure, UPS will provide power to connected devices.

Step 3: Communication connection



To allow for unattended UPS shutdown/start-up and status monitoring, connect the communication cable one end to the RS-232 port and the other to the communication port of your PC. With the monitoring software installed, you can schedule UPS shutdown/start-up and monitor UPS status through PC.

1kVA, 2kVA, 3kVA, 5kVA models are equipped with intelligent slot perfect for SNMP, RS-232, USB or Relay/AS400 card. When installing with these communication card in the UPS, it will provide advanced communication and monitoring options.

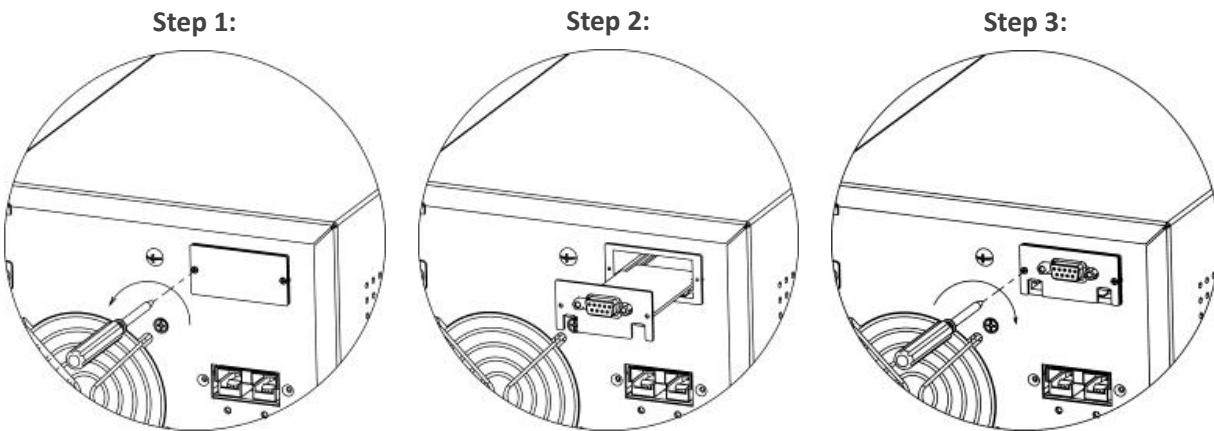

Remove cover of intelligent slot.
Insert communication card into the slot
Screw card tightly and complete installation.

Step 4: Network connection

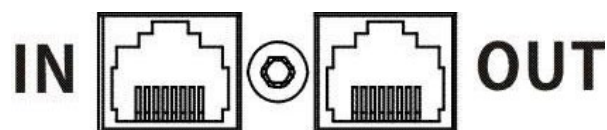

Connect a single modem/phone/fax line into surge-protected "IN" outlet on the back panel of the UPS unit. Connect from "OUT" outlet to the equipment with another modem/fax/phone line cable.

Step 5: Turn on the UPS

Press the ON/Mute button on the front panel for two seconds to power on the UPS.

Note: The battery charges fully during the first five hours of normal operation. Do not expect full battery run capability during this initial charge period.

Step 6: Install software

For optimal computer system protection, install UPS monitoring software to fully configure UPS shutdown. You may insert provided CD into CD-ROM to install the monitoring software. If not, please follow steps below to download and install monitoring software from the internet:

1. Go to the website <http://www.power-software-download.com>
2. Click ViewPower software icon and then choose your required OS to download the software.
3. Follow the on-screen instructions to install the software.
4. When your computer restarts, the monitoring software will appear as an orange plug icon located in the system tray, near the clock.

Step 7: External battery connection

Follow the below chart to make external battery connection.

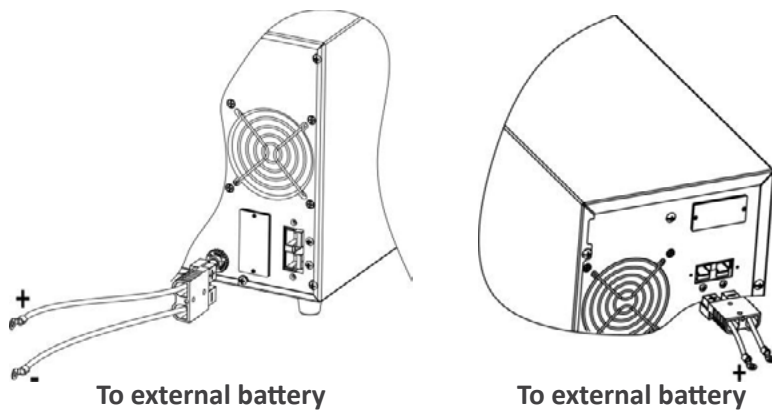

Step 8: External battery capacity configuration in software

To calculate accurate backup time of external batteries, it's necessary to configure battery numbers in software. The standard calculated capacity for one battery is 9Ah. If connecting to 100Ah batteries, then it's equal to 11 in parallel ($100\text{Ah} / 9\text{Ah} \approx 11$ sets).

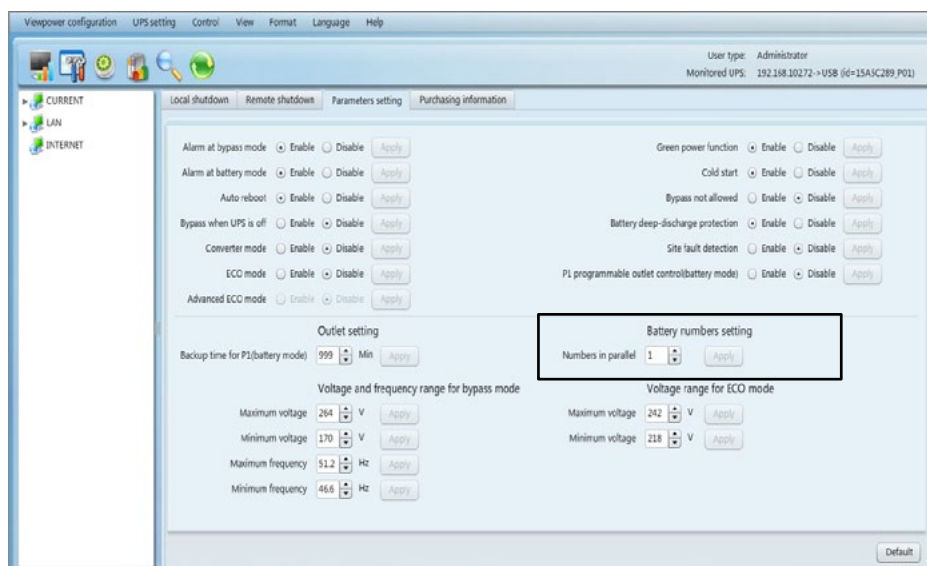

Operations



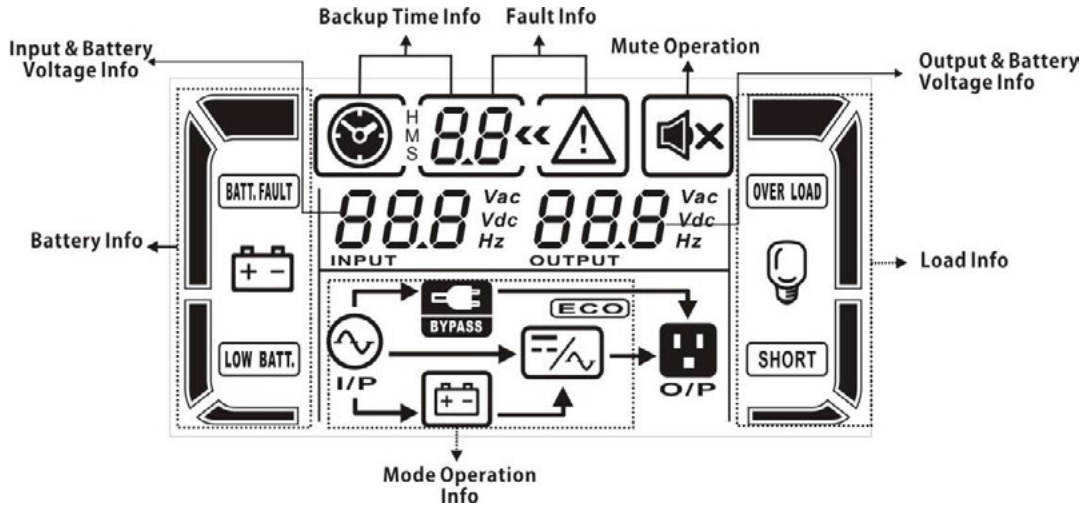

Button Operation

Button	Function
ON/Mute Button	<ul style="list-style-type: none"> • Turn on the UPS: Press and hold ON/Mute button for at least 2 seconds to turn on the UPS. • Mute the alarm: After the UPS is turned on in battery mode, press and hold this button for at least 5 seconds to disable or enable the alarm system. But it's not applied to the situations when warnings or errors occur. • Up key: Press this button to display previous selection in UPS setting mode. • Switch to UPS self-test mode: Press ON/Mute buttons simultaneously for 5 seconds to enter UPS self-testing while in AC mode or converter mode.
OFF/Enter Button	<ul style="list-style-type: none"> • Turn off the UPS: Press and hold this button at least 2 seconds to turn off the UPS in battery mode. UPS will be in standby mode under power normal or transfer to Bypass mode if the Bypass enable setting by pressing this button. • Confirm selection key: Press this button to confirm selection in UPS setting mode.
Select Button	<ul style="list-style-type: none"> • Switch LCD message: Press this button to change the LCD message for input voltage, input frequency, battery voltage, output voltage and output frequency. It will return back to default display when pausing for 10 seconds. • Setting mode: Press and hold this button for 5 seconds to enter UPS setting mode when UPS is in standby mode or bypass mode. • Down key: Press this button to display next selection in UPS setting mode.
ON/Mute + Select Button	<ul style="list-style-type: none"> • Switch to bypass mode: When the main power is normal, press ON/Mute and Select buttons simultaneously for 5 seconds. Then UPS will enter to bypass mode. This action will be ineffective when the input voltage is out of acceptable range.
ON/Mute + Select Button	<ul style="list-style-type: none"> • Switch to UPS self-test mode: Press ON/Mute and OFF/Enter buttons Simultaneously for 5 seconds to enter UPS self-testing while in AC mode or converter mode

LCD Panel



Display	Function
Backup time information	
	Indicates the backup time in pie chart.
H M S 8.8	Indicates the backup time in numbers. H: hours, M: minute, S: second
Fault information	
	Indicates that the warning and fault occurs.
8.8	Indicates the warning and fault codes, and the codes are listed in details in 3-5 section.
Mute operation	
	Indicates that the UPS alarm is disabled.
Output & Battery voltage information	
888 Vac Vdc Hz OUTPUT	Indicates the output voltage, frequency or battery voltage. Vac: output voltage, Vdc: battery voltage, Hz: frequency
Load information	
	Indicates the load level by 0-25%, 26-50%, 51-75%, and 76-100%.
	Indicates overload.
	Indicates the load or the UPS output is short circuit.
Mode operation information	
	Indicates the UPS connects to the mains.

	Indicates the battery is working.
	Indicates the bypass circuit is working.
	Indicates the Inverter circuit is working.
	Indicates the output is working.

Audible Alarm

Battery Mode	Sounding every 4 seconds
Low Battery	Sounding every second
Overload	Sounding twice every second
Fault	Continuously sounding
Bypass Mode	Sounding every 10 seconds

LCD Display Wordings Index

Abbreviation	Display content	Meaning
ENA	<i>ENA</i>	Enable
DIS	<i>DIS</i>	Disable
ESC	<i>ESC</i>	Escape
HLS	<i>HLS</i>	High loss
LLS	<i>LLS</i>	Low loss
BAT	<i>BAT</i>	Battery
CF	<i>CF</i>	Converter
TP	<i>TP</i>	Temperature
CH	<i>CH</i>	Charger

UPS Setting

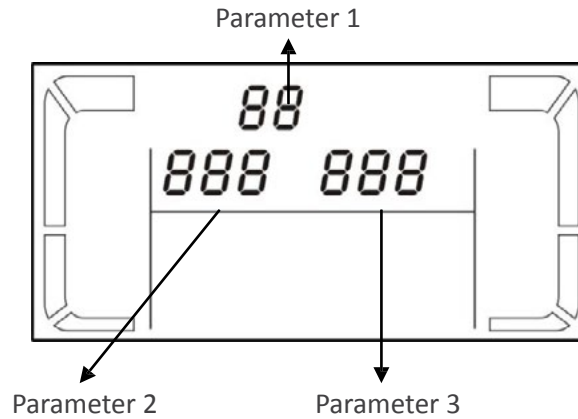

There are three parameters to set up the UPS.

Parameter 1: It's for program alternatives. There are 6 programs to set up. Refer to below table.
 Parameter 2 and Parameter 3 are the setting options or values for each program.

01: Output voltage setting

Interface	Setting
	<p>For 208/220/230/240 VAC models, you may choose the following output voltage:(Default 230Vac/120Vac)</p> <ul style="list-style-type: none"> 208: presents output voltage is 208Vac 220: presents output voltage is 220Vac 230: presents output voltage is 230Vac 240: presents output voltage is 240Vac <p>For 110/115/120/127 VAC models, you may choose the following output voltage:</p> <ul style="list-style-type: none"> 110: presents output voltage is 110Vac 115: presents output voltage is 115Vac 120: presents output voltage is 120Vac 127: presents output voltage is 127Vac

02: Input voltage acceptable range setting

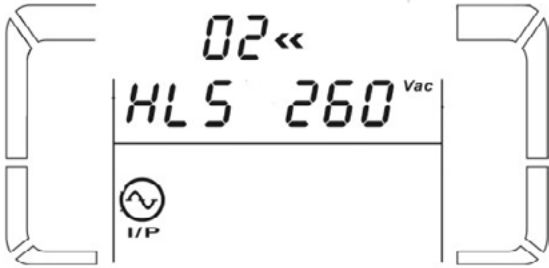
Interface	Setting
	<p>Press the Down key or Up key to set the acceptable high voltage point and acceptable low voltage point of the input: (DefaultHLS:144V/288V;LLS:88V/176V) HLS: High loss voltage in Line mode For Vout 208/220/230/240 VAC models, the setting range is from 260V to 288V(half of the setting voltage in LV mains) For Vout 110/115/120/127 VAC models, the setting range is from 130V to 144V (twice of the setting voltage in HV mains) LLS: Low loss voltage in Line mode For Vout 208/220/230/240 VAC models, the setting range is from 176V to 190V(half of the setting voltage in LV mains) For Vout 110/115/120/127 VAC models, the setting range is from 88V to 95V(twice of the setting voltage in HV mains)</p>

03: ECO enable/disable

Interface	Setting
	<p>ENA: ECO mode enable (DefaultDIS) DIS: ECO mode disable</p>

04: ECO voltage range setting

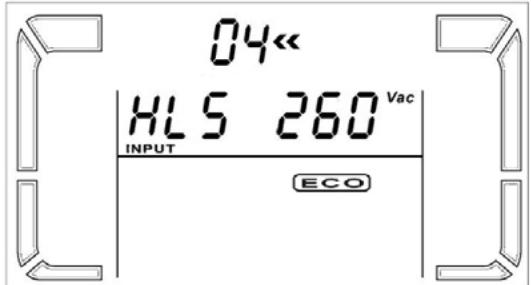
Interface	Setting
	<p>Press the Down key or Up key to set the acceptable high voltage point and acceptable low voltage point: HLS: High loss voltage in ECO mode For 208/220/230/240 VAC models, the setting range is from 7V to 24V of the nominal output voltage For 110/115/120/127 VAC models, the setting range is from 3V to 12V of the nominal output voltage. LLS: Low loss voltage in ECO mode For 208/220/230/240 VAC models, the setting range is from -7V to -24V of the nominal output voltage For 110/115/120/127 VAC models, the setting range is from -3V to -12V of the nominal output voltage.</p>

05: Bypass mode enable/disable

Interface	Setting
	<p>ENA: Bypass mode enable (DefaultDIS) DIS: Bypass mode disable</p>

06: Bypass voltage range setting

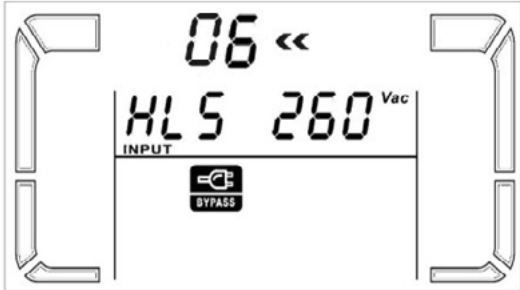
Interface	Setting
	<p>Press the Down key or Up key to set the acceptable high voltage point and acceptable low voltage point: For 208/220/230/240 VAC models (Default HLS:132V/264V;LLS:88V/176V) HLS: Bypass high voltage point setting the high voltage point from 230Vac to 264Vac LLS: Bypass low voltage point setting the high voltage point from 176Vac to 220Vac For 110/150/120/127 VAC models HLS: Bypass high voltage point setting the high voltage point from 120Vac to 132Vac LLS: Bypass low voltage point setting the high voltage point from 88Vac to 115Vac</p>

Note: When the bypass voltage range setting, the ups can not return to bypass mode again.

07: Bypass frequency range setting

Interface	Setting
	<p>Press the Down key or Up key to set the acceptable high frequency point and acceptable low frequency point:For 50Hz models: (Default HLS:63.0Hz/53.0Hz;LLS:57.0Hz/47.0Hz) 51.0-55.0:setting high frequency point from 51.0Hz to 55.0Hz; 45.0-49.0:setting high frequency point from 45.0Hz to49.0Hz; For 60Hz models: 61.0-65.0:setting high frequency point from 61.0Hz to 65.0Hz; 55.0-59.0:setting high frequency point from 55.0Hz to 59.0Hz;</p>

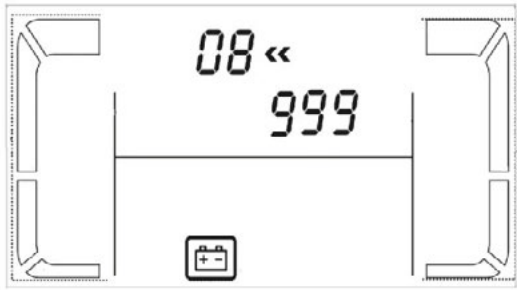

08: Autonomy limitation

Interface	Setting
	<p>DISCHARGETIME= SETTING NUMBER*60 SECOND Default (999) 0: DISCHARGE AT LEAST 10 SECOND 999: DISABLE THIS FUNCTION</p>

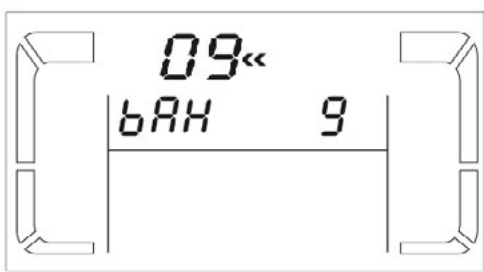

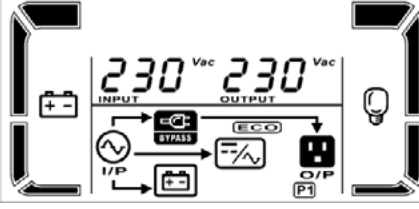
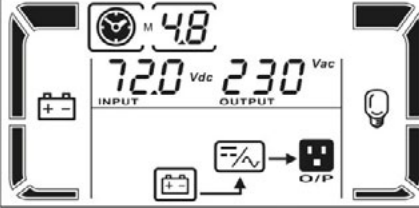

09: Battery AH setting

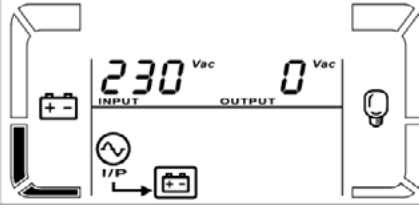
Interface	Setting
	<p>Press the function key to set the Battery AH of UPS. 0-999: if you change the battery AH of UPS, please set the correct AH for the ups. Unit (AH)</p>







Operating Mode Description

Operating mode	Description	LCD display
Online mode	When the input voltage is within acceptable range, UPS will provide pure and stable AC power to output. The UPS will also charge the battery at online mode.	
ECO mode	Energy saving mode: When the input voltage is within voltage regulation range, UPS will bypass voltage to output for energy saving.	
Battery mode	When the input voltage is beyond the acceptable range or power failure and alarm is sounding every 4 second, UPS will backup power from battery.	
Bypass mode	When input voltage is within acceptable range but UPS is overload, UPS will enter bypass mode or bypass mode can be set by front panel. Alarm is sounding every 10 second.	
Standby mode	UPS is powered off and no output supply power, but still can charge batteries.	

Faults Reference Code

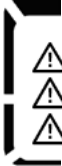







Fault event	Fault code	Icon	Fault event	Fault code	Icon
Bus start fail	01	x	Inverter voltage Low	13	x
Bus over	02	x	Inverter output short	14	
Bus under	03	x	Battery voltage too high	27	
Bus unbalance	04	x	Battery voltage too low	28	
Inverter soft start fail	11	x	Over temperature	41	x
Inverter voltage high	12	x	Over load	43	

Warning Indicator

Warning	Icon (flashing)	Alarm
Low Battery		Sounding every second
Overload		Sounding twice every second
Battery is not connected		Sounding every second
Over Charge		Sounding every second
Over temperature		Sounding every second
Charger failure		Sounding every second
Out of bypass voltage range		Sounding every second

Troubleshooting

If the UPS system does not operate correctly, please solve the problem by using the table below.

Symptom	Possible cause	Remedy
No indication and alarm even though the mains is normal.	The AC input power is not connected well.	Check if input power cord firmly connected to the mains.
	The AC input is connected to the UPS output.	Plug AC input power cord to AC input correctly.
The icon  and  flashing on LCD display and alarm is sounding every second.	The external or internal battery is incorrectly connected.	Check if all batteries are connected well.
Fault code is shown as 27 and the icon  is lighting on LCD display and alarm is continuously sounding.	Battery voltage is too high or the charger is fault.	Contact your dealer.
Fault code is shown as 28 and the icon  is lighting on LCD display and alarm is continuously sounding.	Battery voltage is too high or the charger is fault.	Contact your dealer.
The icon  and  is flashing on LCD display and alarm is sounding twice every second.	UPS is overload	Remove excess loads from UPS output.
	UPS is overloaded. Devices connected to the UPS are fed directly by the electrical network via the Bypass.	Remove excess loads from UPS output.
	After repetitive overloads, the UPS is locked in the Bypass mode. Connected devices are fed directly by the mains.	Remove excess loads from UPS output first. Then shut down the UPS and restart it.
Fault code is shown as 43 and The icon  is lighting on LCD display and alarm is continuously sounding.	The UPS shut down automatically because of overload at the UPS output.	Remove excess loads from UPS output and restart it.
Fault code is shown as 14 and the icon  is lighting on LCD display and alarm is continuously sounding.	The UPS shut down automatically because short circuit occurs on the UPS output.	Check output wiring and if connected devices are in short circuit status.
Fault code is shown as 1, 2, 3, 4, 11, 12, 13 and 41 on LCD display and alarm is continuously sounding.	A UPS internal fault has occurred. There are two possible results: 1. The load is still supplied, but directly from AC power via bypass. 2. The load is no longer supplied by power.	Contact your dealer

Battery backup time is shorter than nominal value	Batteries are not fully charged	Charge the batteries for at least 5 hours and then check capacity. If the problem still persists, consult your dealer.
	Batteries defect	Contact your dealer to replace the battery.

Storage And Maintenance Operation

The UPS system contains no user-serviceable parts. If the battery service life (3-5 years at 25°C ambient temperature) has been exceeded, the batteries must be replaced. In this case, please contact your dealer.



Be sure to deliver the spent battery to a recycling facility or ship it to your dealer in the replacement battery packing material.

Storage

Before storing, charge the UPS 5 hours. Store the UPS covered and upright in a cool, dry location. During storage, recharge the battery in accordance with the following table:

Storage Temperature	Recharge Frequency	Charging Duration
-20°C - 40°C	Every 3 months	1-2 hours
40°C - 45°C	Every 2 months	1-2 hours

Specifications

MODEL NUMBER		TX90-1000	TX90-2000	TX90-3000	TX90i-5000
CAPACITY	Power rating	1000VA (800W)	2000VA (1600W)	3000VA (2400W)	5000VA (4000W)
INPUT	Voltage	88–144VAC and 176–288VAC (auto sensing)*			160–300VAC*
	Frequency	40–70Hz			
	Surge rating	> 600J line to neutral			
	Input current 230V/120V	4.6A / 9.7A	9.2A / 19.4A	13.9A / 29.1A	22.3A
OUTPUT	Voltage	100/110/115/120/127VAC (TX90) user selectable** 200/208/220/230/240VAC (TX90i) user selectable***			200/208/220/230/ 240VAC****
	Waveform	Sine wave			
	Frequency	50Hz ± 3Hz or 60Hz ± 3Hz synchronized with input			
	Transfer time	AC mode to Battery mode = 0 ms; AC mode to Bypass/ECO = 4 ms; Bypass/ECO to AC mode = 4 ms; ECO to Battery mode = 10 ms			
	Harmonic distortion	≤ 3% THD (linear load); ≤ 7% THD (non-linear mode)			
	Overload capacity	> 100% for 30 sec, > 130% for 1.5 sec			
BATTERY	Charge current	1.0A			
	Battery type	(2) 12V 9AH	(4) 12V 9AH	(6) 12V 9AH	(8) 12V 10AH
	Battery runtime	Half load = 11 min; full load = 5 min			
	Recharge	5 hours to 90% capacity			
PHYSICAL	UPS dimensions (W x D x H)	5.7 x 16.6 x 13.1 in (145 x 421 x 332 mm)	7.5 x 16.8 x 17.6 in (190 x 426 x 448 mm)		
	UPS weight	58.5 lbs (26.5 kg)	89 lbs (40.5 kg)	136 lbs (61.7 kg)	156 lbs (70.8 kg)
	Input connection	IEC C14 inlet	Terminal block w/ IEC C20	Terminal block or input cord (optional)	
	Receptacles (TX90)	(4) 5–15R	(8) 5–15/20R	(6) 5–15/20R + HW	N/A
	Receptacles (TX90i)	(4) IEC C13	(8) IEC C13	(6) IEC C13 + terminal block	
	LCD display	UPS status, load level, battery level, input/output/battery status, discharge timer, fault conditions			
APPROVALS	CE, RoHS				
WARRANTY	3 years electronics, 3 year battery warranty (USA and Canada)				
COMMUNICATIONS INTERFACE	Standard RS-232, optional USB, Web/SNMP, Relay/dry contact, and Modbus card				
INCLUDED IN BOX	Local monitoring CD, RS-232 cable, user manual				
AVAILABLE OPTIONS	Caster base, input cord sets, output receptacles (including NEMA L6–20R, L6–30R, or 6–15/20R), power distribution (XPDU)				

*Depending on load level

**TX90 capacity derates 20% at 100V output

***TX90i 1000-3000 capacity derates 20% at 200V and 208VAC output voltage

****TX90i-5000 capacity derates 20% at 200/208VAC output voltage

Obtaining Service

If the UPS requires Service:

1. Use the TROUBLESHOOTING section in this manual to eliminate obvious causes.
2. Verify there are no circuit breakers tripped.
3. Call your dealer for assistance. If you cannot reach your dealer, or if they cannot resolve the problem, call Xtreme Power Conversion Corp Technical Support at 800.582.4524. Technical support inquiries can also be made at support@xpcc.com. Please have the following information available BEFORE calling the Technical Support Department:
 - Your name and address.
 - The serial number of the unit.
 - Where and when the unit was purchased.
 - All of the model information about your UPS.
 - Any information on the failure, including LED's that may or may not be illuminated.
 - A description of the protected equipment, including model numbers if possible.
 - A technician will ask you for the above information and, if possible, help solve your problem over the phone. In the event that the unit requires factory service, the technician will issue you a Return Material Authorization number (RMA).

If you are returning the UPS to Xtreme Power for service, please follow these procedures:

1. Pack the UPS in its original packaging. If the original packaging is no longer available, ask the Technical Support Technician about obtaining a replacement set of packaging material. It is important to pack the UPS properly in order to avoid damage in transit. Never use Styrofoam beads for a packing material.
2. Include a letter with your name, address, daytime phone number, RMA number, a copy of your original sales receipt, and a brief description of the problem.
3. Mark the RMA number on the outside of all packages. Xtreme Power cannot accept any package without the RMA number marked on the outside of the boxes.
4. Return the UPS by insured, prepaid carrier to the address provided by the Technician.
5. Refer to the Warranty statements in this manual for additional details on what is covered.

Xtreme Power Conversion Limited Warranty

Xtreme Power Conversion (XPC) Corporation warrants Xtreme Power Conversion equipment, when properly applied and operated within specified conditions, against faulty materials or workmanship for a period of **three years for TX90-Series products** from the date of purchase. XPC Corporation warrants **internal batteries for a period of three years** from the date of purchase. For equipment sites within the United States and Canada, this warranty covers repair or replacement, at the sole discretion of XPC Corporation. The customer is responsible for the costs of shipping the defective product to XPC Corporation. XPC Corporation will pay for ground shipment of the repaired or replacement product. This warranty applies only to the original purchaser.

If equipment provided by XPC Corporation is found to be **Dead-on-Arrival (DOA)**, XPC Corporation will be responsible for the costs of shipping product to and returning equipment from the customer in a timely manner as agreed to with the customer, once the customer has requested and received a **Return Material Authorization (RMA)** number. DOA equipment is defined as equipment that does not properly function according to user documentation when initially received and connected in conjunction with proper procedures as shown in the user documentation or via support provided by XPC Corporation personnel or authorized agents.

This warranty shall be void if (a) the equipment is repaired or modified by anyone other than XPC Corporation or a XPC Corporation approved third party; (b) the equipment is damaged by the customer, is improperly used or stored, is subjected to an adverse operating environment, or is operated outside the limits of its electrical specifications; or (c) the equipment has been used or stored in a manner contrary to the equipment's operating manual, intended use or other written instructions. Any technical advice furnished by XPC Corporation or a XPC Corporation authorized representative before or after delivery with regard to the use or application of Xtreme Power Conversion equipment is furnished on the basis that it represents XPC Corporations best judgment under the situation and circumstances, but it is used at the recipient's sole risk.

EXCEPT AS STATED ABOVE, XPC Corporation DISCLAIMS ALL WARRANTIES, EXPRESSED OR IMPLIED, INCLUDING WARRANTIES OF MERCHANTABILITY AND FITNESS FOR A PARTICULAR PURPOSE.

EXCEPT AS STATED ABOVE, IN NO EVENT WILL XPC Corporation BE LIABLE FOR DIRECT, INDIRECT, SPECIAL, INCIDENTAL, OR CONSEQUENTIAL DAMAGES ARISING OUT OF THE USE OF Xtreme Power Conversion EQUIPMENT, including but not limited to, any costs, lost profits or revenue, loss of equipment, loss of use of equipment, loss of software, loss of data, cost of substitutes, or claims by third parties. Purchaser's sole and exclusive remedy for breach of any warranty, expressed or implied, concerning Xtreme Power Conversion equipment, and the only obligation of XPC Corporation under this warranty, shall be the repair or replacement of defective equipment, components, or parts; or, at XPC Corporations sole discretion, refund of the purchase price or substitution of an equivalent replacement product.

Xtreme Power Conversion Load Protection Policy

THIS POLICY IS NOT A WARRANTY. REFER TO **THE XPC CORPORATION, INC. LIMITED WARRANTY** FOR INFORMATION CONCERNING THE WARRANTY FOR YOUR XPC PRODUCT. THE LIMITATIONS AND CONDITIONS CONTAINED IN THIS POLICY DO NOT AFFECT **THE TERMS OF THE XPC LIMITED WARRANTY**.

Definitions:

1. "Product" means a Standard 120, 208, or 240 Volt power protection device that is used in the United States and Canada. This policy does not include custom manufactured products.
2. "Power Disturbance" means an AC power line transient (telephone line or Local Area Network, if applicable), spike or surge.
3. "Connected Equipment" properly connected electronic equipment
4. "Fair Market Value" of damaged Connected Equipment as determined by XPC shall be the lower of (a) the average price the same or similar items are being sold for on eBay, (b) the price list of Orion Blue Book (or if such price list is no longer published, a published or announced price list reasonably selected by XPC), (c) the lowest price the same or similar items can be purchased for in the United States or (d) the total amount of all payment(s) you have or are entitled to receive from insurance, other warranties, extended warranties, a legal liability claim or from other sources or persons for the damaged Connected Equipment.
5. "Purchaser" means the person or entity that originally purchased the Product from an authorized reseller or distributor of XPC Products.

The Purchaser of this Product is protected, for the term of the XPC Limited Warranty, against certain losses caused by a Power Disturbance for properly connected electronic equipment (referred to as the "Connected Equipment") subject to certain terms and conditions provided below.

This policy applies only to the original purchaser of the Product. If the Product is transferred or sold to another person or entity, this policy is void.

Load Protection Policy Dollar and Period Limits

For purchasers that meet the qualifications and conditions set forth in this policy, XPC will provide reimbursement (cost of repair or fair market value as determined by XPC) during the period limits and up to the dollar limits stated as follows:

PRODUCT	DOLLAR LIMIT	PERIOD OF COVERAGE
XVT	25,000	Term of XPC Limited Warranty
XST	25,000	Term of XPC Limited Warranty
S70	25,000	Term of XPC Limited Warranty
XPRT 6kVA & 10kVA	50,000	Term of XPC Limited Warranty
NXRT	50,000	Term of XPC Limited Warranty
P90, P90L, P90g, P90Lg	50,000	Term of XPC Limited Warranty
T90	50,000	Term of XPC Limited Warranty
TX90, TX90i	50,000	Term of XPC Limited Warranty

This Load Protection Policy is not deemed "first dollar" coverage. XPC's obligation is reduced by any amounts that the Purchaser is entitled to recover, from other sources regarding the Connected Equipment, including, but not limited to, insurance, other warranty, extended warranty, or legal liability, regardless of whether or not the Purchaser makes a claim for recovery.

Eligibility for Coverage Under the Load Protection Policy

1. The Product must be registered on the XPC website, www.xpcc.com, within 10 days of purchase. All required information must be provided, and Purchaser should retain a copy for Purchaser's records. When registering on the website, Purchaser must list all connected equipment that is directly connected to the

product. Only those devices registered in that manner will be covered.

2. All Connected Equipment must be UL or CSA approved.
3. The Product must be plugged into a properly wired and grounded outlet. Use of input surge devices, extension cords, adapters, ground wires, or electrical connections not manufactured by XPC voids the XPC Load Protection Policy. No other surge protection device may be connected to the output sockets of the Product. The installation must comply with all applicable electrical and safety codes set forth pursuant to the NEC.
4. The Product must have undeniable physical evidence of a Power Disturbance that directly and proximately caused the damage;
5. The Connected Equipment must have been damaged by a Power Disturbance on a properly installed, grounded, and National Electric Code, ("NEC"), code-compliant 120, 208, 240 Volt AC power line in the United States or Canada, by a Power Disturbance on standard telephone land line or PBX telephone equipment line that is properly installed and connected to an RJ11 port on the Product; or by a Power Disturbance on a standard Local Area Network connection that is properly installed and connected to an RJ45 port on the Product and (d) is directly plugged into, and properly connected to, the Product in its original condition which was properly operated when a Power Disturbance passed through the Product and (i) exhausts the protection capacity of the Product or (ii) damages the Product.
6. The Load Protection Policy does not apply if the Product has been operated in a failure mode or not in compliance with XPC operating instructions in the Product user's manual, or if the Connected Equipment has not been operated in compliance with the instructions and manuals of its manufacturer/vendor.
7. This policy is null and void if, XPC determines, in its sole discretion, that the Product has been tampered with or altered in any way.

What is Not Covered Under the Load Protection Policy:

The following damage is not covered by this Policy:

1. Restoration of lost data and reinstallation of software.
2. Damage from a cause other than AC power-line transients, except for damage due to telephone line, Local Area Network, or CATV transients, which is covered only if the Product offers such protection.
3. DAMAGE CAUSED BY FAILURE TO PROVIDE A SUITABLE INSTALLATION ENVIRONMENT FOR THE PRODUCT (INCLUDING, BUT NOT LIMITED TO, LACK OF A PROPER SAFETY GROUND).
4. Damage caused by the use of the Product for purposes other than those for which it was designed.
5. Damage caused by accidents, or natural disasters, including but not limited to, fire, flood, and wind.
6. Damage caused by abuse, misuse, alteration, modification, or negligence.
7. Any labor costs or travel, room and board expenses associated with the repair and/or restoration of lost or damaged hardware, software or data.

EXCEPT AS EXPRESSLY PROVIDED IN THIS POLICY, XPC SHALL NOT BE LIABLE FOR ANY DAMAGES WHATSOEVER, INCLUDING, BUT NOT LIMITED TO, DIRECT, INDIRECT, SPECIAL, INCIDENTAL, CONSEQUENTIAL, OR MULTIPLE DAMAGES ARISING OUT OF THE USE OF THE PRODUCT OR DAMAGE TO THE CONNECTED EQUIPMENT, REGARDLESS OF THE LEGAL THEORY ON WHICH SUCH CLAIM IS BASED, EVEN IF ADVISED OF THE POSSIBILITY OF SUCH DAMAGE. SUCH DAMAGES INCLUDE, BUT ARE NOT LIMITED TO, LOSS OF PROFITS, LOSS OF SAVINGS OR REVENUE, LOSS OF USE OF THE PRODUCT OR THE CONNECTED EQUIPMENT OR ANY ASSOCIATED EQUIPMENT, LOSS OF SOFTWARE, COST OF CAPITAL, COST OF ANY SUBSTITUTE EQUIPMENT, FACILITIES OR SERVICES, DOWNTIME, THE CLAIMS OF THIRD PARTIES, INCLUDING CUSTOMERS, AND INJURY TO PROPERTY.

Submitting a Load Protection Policy Claim:

1. Any claim under the Load Protection Policy must be made within 10 days of the date of alleged damage to the Connected Equipment.
2. Call the XPC technical support department at 1-800- 582-4524 and obtain a Load Protection Policy Returned Material Authorization (RMA) number. Have information on all applicable insurance or other resources of recovery/payment that is available to the Purchaser and the name of the power utility supplier for the location of the Connected Equipment. XPC will forward to the Purchaser a Load Protection Policy claims form, which

must be completed and filed with XPC within 30 days.

- Mark the Load Protection Policy RMA number on the Product the Purchaser is returning.
- Pack the Product in its original packaging or similar packing materials if the original packaging has been discarded. Enclose the completed Load Protection Policy claim form and a copy of the Purchaser's original sales receipt for the Product in the box.
- Mark the RMA number clearly on the outside of the box.
- Ship the Product (one-way shipping charges paid by the Purchaser) to:

XPC Corporation
230 Yuma Street
Denver, CO 80223
Attn: LPP RMA#

3. XPC will evaluate the Product to determine its level of functionality, and will examine the Product for evidence of damage from a Power Disturbance.
 - If XPCs' evaluation provides no evidence of damage from a Power Disturbance, XPC will send to the Purchaser (i) a report summarizing the tests performed and (ii) a rejection of claim notice.
 - If the Product shows evidence of damage from a Power Disturbance, XPC will request that all Connected Equipment for which a Load Protection Policy claim has been submitted, be sent for evaluation to either XPC or an authorized service center. If it is determined that the Connected Equipment has been damaged by a Power Disturbance, XPC will, in its sole discretion, issue payment to the Purchaser for either the cost of repair of the Connected Equipment or the Fair Market Value of the damaged Connected Equipment, up to the dollar limits stated above. XPC reserves the right to require the Purchaser to transfer title and deliver the Connected Equipment to XPC if it chooses to reimburse the Purchaser for the fair market value of the Connected Equipment. XPCs' maximum liability shall be reduced to reflect all such other payments or sources of recovery, whether applied for or not.
4. If XPC issues payment to the Purchaser to have the Connected Equipment repaired, the repair must be performed at a service center that is authorized by the manufacturer of the Connected Equipment. XPC reserves the right to contact the authorized service center directly to discuss repair costs and damage to the Connected Equipment to determine if it was caused by a Power Disturbance and the right to request that the service center forward the Connected Equipment or components of the Connected Equipment to XPC for inspection
5. Unless modified in writing signed by an officer of XPC and the Purchaser, the terms of this policy are the complete and exclusive agreement between the parties, superseding all prior agreements, oral or written, and all other communications between the parties relating to the subject matter of this agreement. No employee of XPC or any other party is authorized to make any representations beyond those made in this agreement concerning the Load Protection Policy.

XPC Corporation
230 Yuma Street
Denver, CO 80223
1.800.582.4524