



T90 Online UPS

700VA, 1000VA, 1500VA, 2000VA, 3000VA Models

User & Installation Manual

Table of Contents

EMC Statements - FCC Part 15	4
ICES-003.....	4
Declaration of Conformity Request.....	4
Special Symbols.....	6
Introduction	7
Product Description	7
Double Conversion Online Technology.....	7
Efficiency Optimizer Function.....	8
Free Run Mode.....	8
Diagnostic Tests.....	8
System Configuration.....	8
System Configuration	9
Storage	10
Installation	10
Environment.....	10
Rear Panel Views.....	10
Connection To Mains and Loads.....	13
Computer and Alarm Connections	14
Connecting the UPS to a Computer.....	14
RS-232 Standard Interface Port.....	14
USB Port (option).....	14
EPO Port (Emergency Power Off).....	15
Network Transient Protector.....	15
Load Segments.....	15
User's Guide To Operations	15
Starting and Shutting Down the UPS.....	15
Button Operation.....	15
Control Panel Functions.....	16

Troubleshooting.....19

Maintenance.....20

 Replacing Batteries.....20

Technical Specifications.....21

Terminal Block..... 22

Obtaining Service.....23

Xtreme Power Conversion Limited Warranty.....24

Xtreme Power Conversion Load Protection Policy.....25

EMC Statements - FCC Part 15

Notice: Pursuant to section 15 of the FCC rules, this product has been tested and thereby complies to the conditions of a Class B (700-1500VA) and Class A (2000-3000VA) digital device, which have been established for offering sufficient protection against dangerous interference for installation in a residential area. Installation and use of the equipment should comply with the instructions provided in order to avoid such interference due to the amount of radio frequency energy that is radiated and generated by the equipment. In spite of this, we cannot assure that a certain amount of interference may not occur in some installations. If, by turning on and off, it can be deduced that your radio or television reception is found to be influenced by harmful interference from the equipment, it is recommended to use one of the following preventive measures:

- Place the receiving antenna in a separate location or orientation.
- Ensure a greater distance is achieved between the receiver and the equipment.
- Ensure that your equipment is connected to an outlet on a separate circuit than the receiver.
- Contact a technician experienced with radio and TV or a dealer for further assistance.

ICES-003

This Class B Interference Causing Equipment meets all requirements of the Canadian Interference Causing Equipment Regulations ICES-003.

Declaration of Conformity Request

Units labeled with a CE mark comply with the following standards and directives:

- Harmonic Standards: EN 50091-1-1, EN 62040-1-1 1st / IEC 62040-1-1 1st and EN 50091-2 / EN62040-2 1st / IEC 62040-2 1st.
- EU Directives:73/23/EEC, Council Directive on equipment designed for use within certain voltage limits: 2006/95/EC, Amending Directive 93/68/EEC and 73/23/EEC
89/336/EEC, Council Directive relating to electromagnetic compatibility
2004/108/EC, Amending Directive 92/31/EEC and 89/336/EEC relating to EMC

The EC Declaration of Conformity is available upon request for products with a CE mark.

IMPORTANT SAFETY INSTRUCTIONS: (SAVE THESE INSTRUCTIONS)

- This Manual Contains Important Instructions that should be Followed during Installation and Maintenance of the UPS and Batteries.
- **WARNING:** Intended for installation in a controlled environment. Maximum ambient temperature 40°C.
- **CAUTION:** Risk of electric shock. Refer to top or rear or bottom of UPS for cautionary markings.
- **CAUTION:** Risk of electric shock. Heat sinks are live. Disconnect unit before servicing.
- **CAUTION (UPS Having Internal Batteries):** Risk of electric shock - Hazardous live parts inside this unit are energized from the battery supply even when the input AC power is disconnected.
- **CAUTION (No User serviceable Parts):** Risk of electric shock, do not remove cover. No user serviceable parts inside. Refer servicing to qualified service personnel.

- **CAUTION (Non-isolated Battery supply):** Risk of electric shock, battery circuit is not isolated from AC input, hazardous voltage may exist between battery terminals and ground. Test before touching.
- **WARNING (Fuses):** To reduce the risk of fire, replace only with the same type and rating of fuse.
- **CAUTION:** Do not disconnect battery connector under load.
- **ATTENTION:** Risk of electrical shock. With disconnection of this unit from the mains, hazardous voltage still may be accessible through supply from the batteries. The battery supply should therefore be disconnected in the plus and the minus pole when maintenance or service work inside the battery cabinet or UPS is considered.
- **CAUTION (For any pluggable only):** With the installation of this equipment the sum of the leakage current of the UPS and connected consumer should not exceed 3.5 mA.
- **CAUTION (For permanent connection only):** HIGH LEAKAGE CURRENT, Earth connection essential before supply connection.
- **CAUTION:** Do not dispose of batteries in a fire, the battery may explode.
- **CAUTION:** Do not open or mutilate the battery, released electrolyte is harmful to the skin and eyes.
- **CAUTION:** A battery can present a risk of electric shock and high short circuit current. The following precaution should be observed when working on batteries:
 - A. Remove watches, rings or other metal objects.
 - B. Use only tools with insulated handles.
 - C. Wear rubber gloves and boots.
 - D. Do not lay tools or metal parts on top of batteries.
 - E. Disconnect charging source prior to connecting or disconnecting battery terminals.
- **CAUTION:** Servicing of batteries should be performed or supervised by personnel knowledge of batteries and the required precautions. Keep unauthorized personnel away from batteries.
- **CAUTION:** When replacing batteries, replace with the same type and number of batteries: One Sealed lead acid battery, rated 12 V, 8.5 Ah max.
- **CAUTION:** To reduce the risk of fire, use only No. 26 AWG or larger telecommunication line cord.
- **CAUTION (FOR 1500VA HV Only):** To reduce the risk of fire. Connect only to a circuit provided with 20 amperes maximum branch circuit overcurrent protection in accordance with the National Electric Code, ANSI/NFPA 70".
- **CAUTION (FOR 3000VA Only):** To reduce the risk of fire. Connect only to a circuit provided with 30 amperes maximum branch circuit overcurrent protection in accordance with the National Electric Code, ANSI/NFPA 70".
- **CAUTION (FOR 700-2000VA Only):** To reduce the risk of fire. Connect only to a circuit provided with 20 amperes maximum branch circuit overcurrent protection in accordance with the National Electric Code, ANSI/NFPA 70".

The instructions contained within this safety manual are deemed important and should be closely followed at all times during installation and follow-up maintenance of the UPS and batteries.



CAUTION

The unit has a dangerous amount of voltage. If the UPS indicator is on, the unit's outlets may have a dangerous amount of voltage even when not plugged into the wall outlet because the battery may continue to supply power.

Care should be taken to undertake installation indoors, free from electrically-conductive particles which are under temperature and humidity control, in order to reduce the risk of electric shock.

It is best to disconnect the device using the power supply cord. Ensure that the equipment is placed in a position near the outlet where easily accessible.

Except for replacing the batteries, all servicing on this equipment must be carried out by qualified service personnel.

Before conducting any maintenance, repair, or shipment, first ensure that everything is turned off completely and disconnected.

For additional safety instructions, please use the Safety Manual as a reference.

Special Symbols

The following symbols used on the UPS warn you of precautions:



RISK OF ELECTRIC SHOCK - Please observe the warning that a risk of electric shock is present



CAUTION: REFER TO OPERATOR'S MANUAL - Refer to the operator's manual for additional information, such as important operating and maintenance instructions.



SAFE GROUNDING TERMINAL - Indicates primary safe ground



LOAD ON/OFF – Pressing the button turns on/off the output receptacles and the indicator light.



RJ45 RECEPTACLE – The receptacle provides network interface connections and telephone or telecommunications equipment should not be plugged into it.



Please do not discard the UPS or the UPS batteries as the UPS may have valve-regulated lead-acid batteries. Please recycle batteries appropriately.

Introduction

The information provided in this manual covers single phase T90 700–3000VA UPS, their basic functions, operating procedures, and emergency situations, also including information on how to ship, store, handle and install the equipment. Only detailed requirements of the UPS units are described herein, and installation must be carried out in accordance with this manual. Electrical installations must also carefully follow local legislation and regulations. Only qualified personnel should conduct these installations as failure to acknowledge electrical hazards could prove to be fatal.

Product Description

Several different kinds of sensitive electrical equipment stay protected by a UPS (Uninterruptible Power Supply) including computers, workstations, process control systems, telecommunications systems, sales terminals, other critical instrumentation, etc. The purpose of the UPS is to protect these systems from poor quality utility power, complete loss of power, or other associated problems.

Electrical interference abounds in many forms causing problems in AC power, from lightning, power company accidents and radio transmissions to motors, air conditioners, and vending machines, among others. So protection of sensitive electrical equipment is vital to protect against power outages, low or high voltage, slow voltage fluctuations, frequency variations, differential and common-mode noises, transients, etc.

In order to prevent power line problems reaching critical systems causing damage to software, hardware and causing equipment to malfunction, the UPS helps by maintaining constant voltage, isolating critical load output if needed, and cleaning the utility AC power.

Double Conversion Online Technology

A double conversion on-line technology UPS provides clean, uninterrupted single-phase power to your critical systems, while maintaining the batteries for their maximum potential. In the event that the power failure lasts longer than the UPS backup time, the UPS will shut down avoiding battery damage. When the input AC voltage returns, the UPS will automatically return online to recharge the batteries.

As shown in block diagram:

- An input filter reduces transients on the mains
- For maintaining full battery charge, AC-power is rectified and regulated in the rectifier feeding power to the inverter and battery converter.
- DC power is converted to AC in the inverter passing it on to the load.
- Power is maintained from the battery during a power failure.
- The converter increases voltage appropriately for the inverter

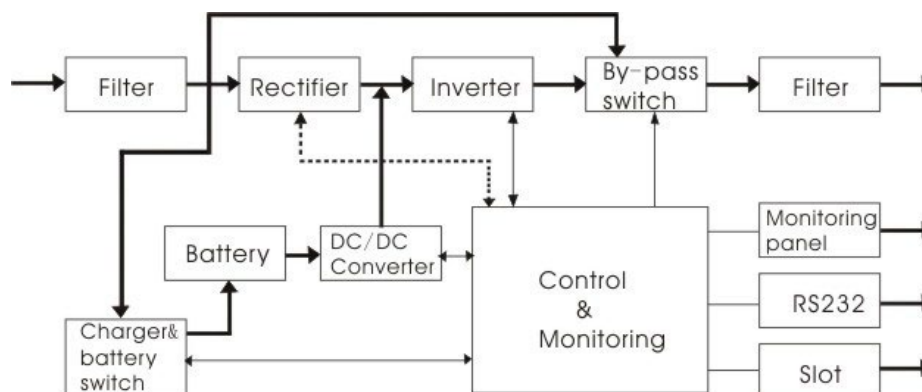

Efficiency Optimizer Function

The Efficiency Optimizer function is a feature of the UPS adding cost effectiveness, minimizing power loss and reducing power consumption. Alternating between bypass and on-line modes is achieved automatically and in accordance with the conditions of the utility power. On-line mode may be used during times of irregular power conditions, and bypass mode when power flows smoothly in order to obtain greatest efficiency. Irregularities can be detected in less than a second, and on-line mode reactivated immediately. Switching back to online mode occurs when input voltage is outside $\pm 10\%$ or nominal ($\pm 15\%$ selectable), when input frequency is outside of $\pm 3\text{Hz}$ or when no input line is available.

Although high efficiency is standard, the default operation is in on-line mode. Bypass can be activated in the LCD panel, though on-line can be run permanently if preferred.

Free Run Mode

The UPS operates in free run mode when input frequency is outside of the selected input frequency range. Free run mode is when output frequency does not match input frequency. When starting the UPS, the frequency regulation detected is 50 or 60 Hz $\pm 0.25\text{Hz}$.

Diagnostic Tests

When you start the UPS, a diagnostic test is automatically executed that checks electronics, battery, and reports any problems on the LCD display.

An advanced battery management system always monitors the conditions of the batteries sends any fore warnings if replacement is needed. Otherwise every 30 days of normal mode operation, a battery discharge test is performed and any problems reported on the LCD display.

Except during the first 24 hours after startup while the UPS is in charging mode, diagnostic tests can be performed manually from the front panel at any time.

System Configuration

The UPS device and the internal backup battery make up the system. Depending on the site and load requirements of the installation, certain additional options are available as a tailored solution.

Planning a UPS system, the following should be taken into consideration:

- The total demand of the protected system shall dictate the output power rating (VA). Allow a margin for future expansion or calculation inaccuracies from measuring power requirements.
- Backup time needed will indicate the battery size needed. If load is less than the UPS nominal power rating then actual backup time is longer.
- The following options are available:
 - » External Battery Cabinets
 - » Maintenance bypass switches
 - » Connectivity options (relay card, SNMP/WEB card)

The following UPS models are available:

Model	Backup time with internal batteries	Recharge time to 90% capacity
T90-700	7 min	3 hours
T90-1000	7 min	3 hours
T90-1500	6 min	3 hours
T90-2000	7 min	3 hours
T90-3000	6 min	3 hours

Additional External Battery Cabinets are available if more back-up time is needed.

System Configuration

Information presented here is vital to all personnel. Please read carefully.

Storage and Transportation

Please handle with extreme caution since a high amount of energy is contained in the batteries. Always keep the unit in an upright position as marked on the packaging and never drop the unit.

Installation

If flammable substances such as gases or fumes are present or if the room is airtight, a safety hazard situation exists, in which no electrical equipment should be operated.

The instructions in this manual explain how to install the UPS safely. Not acknowledging such electrical hazards may be fatal, so keep this manual for all future reference.



WARNING!

It is strongly recommended that the UPS cabinet not be opened as the components have very high voltage and touching them may be fatal. Only a qualified technician or an authorized agent may service the unit.

This UPS unit's output receptacles carry live voltage even when not connected to a power supply as it has its own energy source.

User's Operations

The only operations that users are permitted to do are:

- Turning the UPS unit on and off
- Operating the users interface
- Connecting data interface cables
- Changing the batteries

All such operations are to be performed exactly as instructed in this manual. The greatest care possible must be taken for any of these operations and any change thereof may prove very hazardous to the operator.

Storage

Please adhere to the following instructions if the UPS is not installed immediately:

- Store the equipment as is in its original packing and shipping carton
- Do not store in temperatures outside the range of +15°C to +25°C.
- Ensure that the equipment is fully protected from wet or damp areas and from moist air.

In order to maintain the vitality of the batteries, ensure that the UPS is recharged every 6 months for at least 8 hours.

Installation

Environment

Ensure that all environmental concerns and requirements are met according to these technical specifications, otherwise the safety of installation personnel cannot be guaranteed and the unit may malfunction.

Ensure the following when selecting a location for the UPS system and battery options:

- Avoid extremes of temperature and humidity. Maximum battery life can be attained with a recommended temperature range of 15 °C to 25 °C.
- Provide protection for the equipment from moisture.
- Space and ventilation requirements must be met. Ensure there is 100mm behind and 50mm on the sides of the UPS for ventilation.
- Ensure that the front of the UPS remains clear for user operation.

The External Battery Cabinets may be installed next to the UPS or under the UPS.

Rear Panel Views

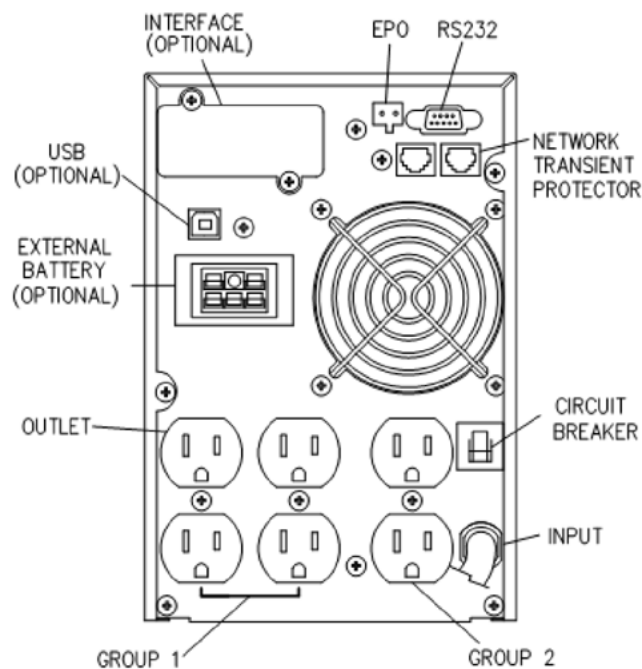

T90-700, T90-1000, T90-1500 rear view

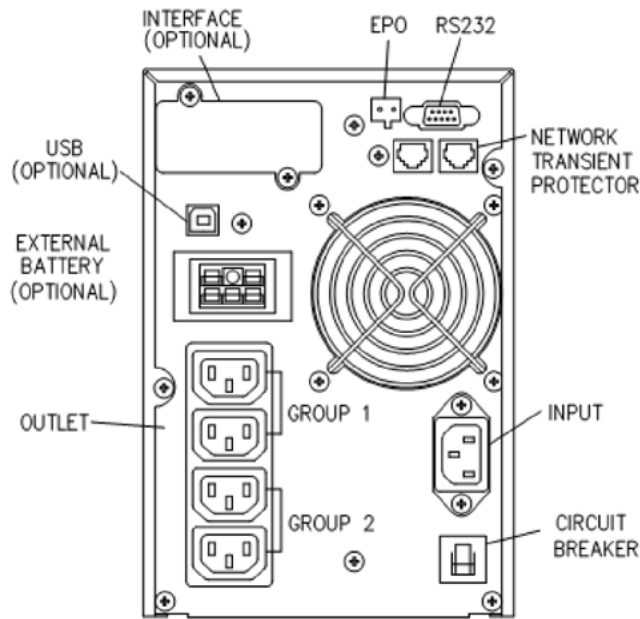

T90i-1500 rear view

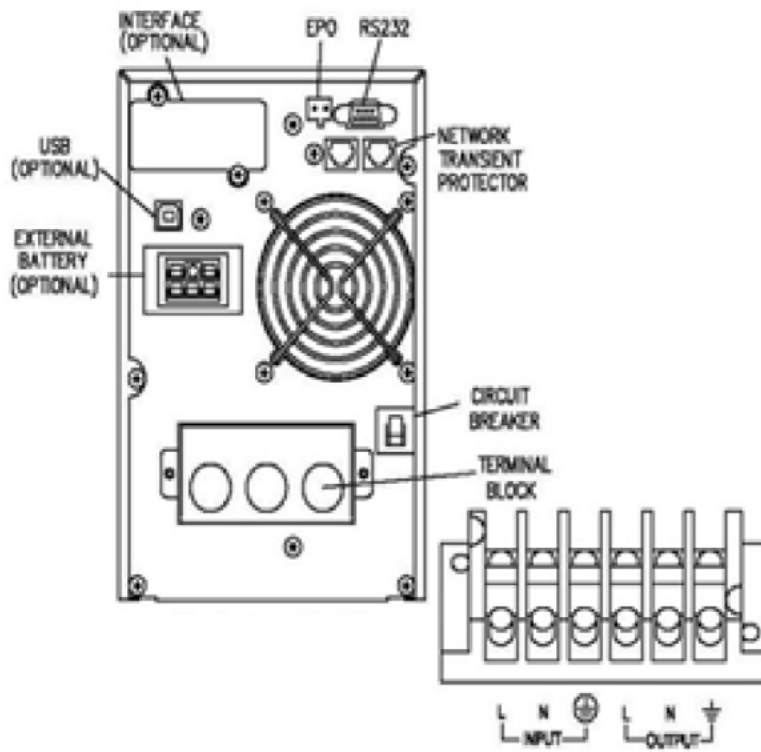

T90-15HW rear view

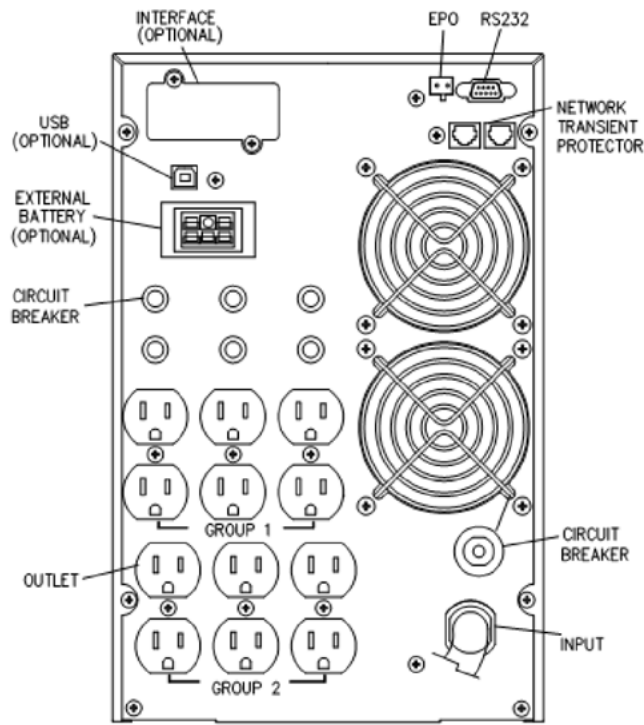

T90-2000 rear view

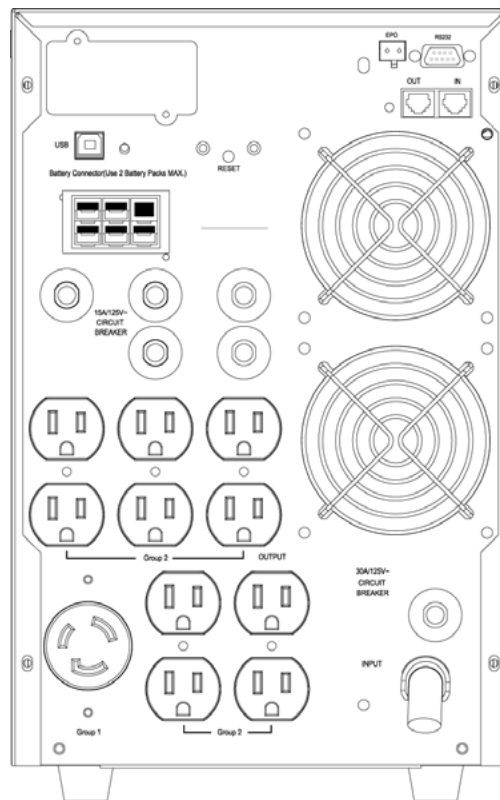

T90-3000 rear view

Connection To Mains and Loads

- Ensure that the UPS is disconnected from mains and loads while connecting the External Battery Cabinets, if needed.
- Use the battery cable that comes with the External Battery Cabinet to connect the External Battery Cabinet to the UPS. Connect a second battery cabinet to the first one with the cable provided if more than one is to be installed.
- Be aware of UPS parameters and changing the Battery pack quantity when using the external battery cabinets.
- Connect the UPS line cord to a grounded outlet. The batteries will automatically charge when connected to the mains. Please realize that although you may start using the UPS immediately, maximum back-up time will still not be available, so it is recommended to charge the batteries for a minimum of 8 hours before use.
- If unit instantly shows a "Site Wiring Fault", rotate the connector (Schuko).
- After charging, connect the loads to the UPS.
- Do not connect any devices that have the possibility of overloading the UPS or drawing half-wave rectified current, such as hair dryers or vacuum cleaners.
- Should computer or alarm connections be used, use connections according to the manual provided with that option. The connections can be referred to on the rear panel.

The installation is now complete.

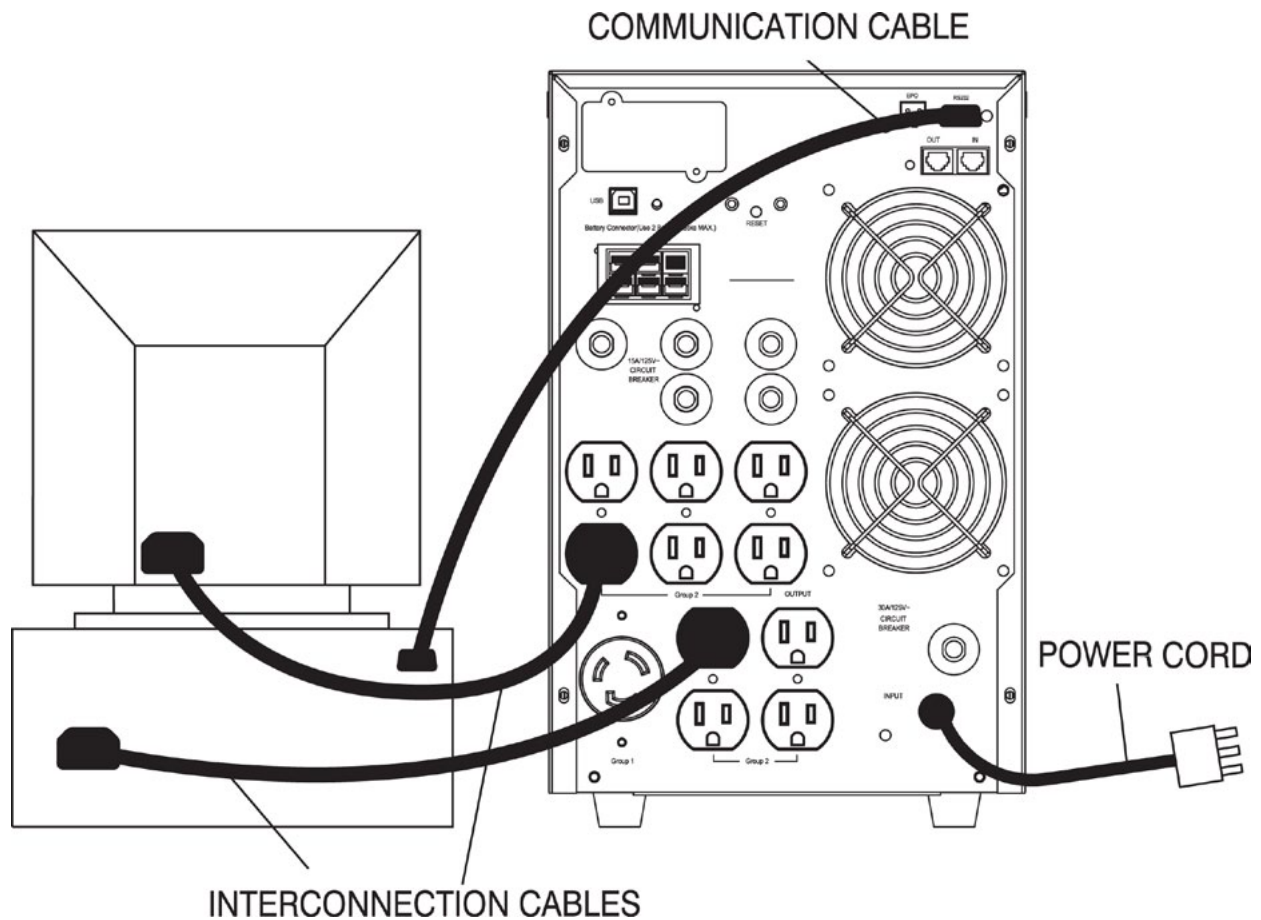

Example of Installation of Plug & Play products

Computer and Alarm Connections

On the rear of the UPS is an interface allowing direct communication with your computer system. There is a RS232 serial data interface, one USB data interface and an emergency power off switch supplied. However, the RS232 port cannot be used when the USB interface is in use.

In addition there is an optional interface slot that allows you to install different communications cards. It can be used parallel with either the RS232 or USB ports.

Currently there are two cards available for the optional interface slot. An SNMP/WEB card allows management and monitoring over a network or internet, and the Relay card allows voltage free relay contacts. Your local dealer will have more information about these option cards.

Connecting the UPS to a Computer

The communication device for the UPS and PC comes as a complete package with power management software. Only the communication cable provided with the UPS may be used to connect to your computer, which is accomplished through the UPS RS232 port. Also ensure that the operating system on your computer is supported. Instructions provided in the power management software will help with this installation.

RS-232 Standard Interface Port

The RS-232 interface uses a 9-pin female D-sub connector. This information consists of data about utility, load and the UPS. The interface port pins and their functions are identified in the following table.

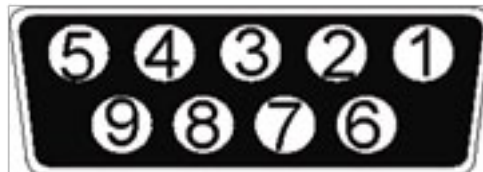

Pin #	Signal name	Direction (re UPS)	Functions
2	TxD	Output	TxD Output
3	RxD	Input	RxD / Inverter Off Input
5	Common		Common
6	AC Fail	Output	Ac Fail Output
8	Low Battery	Output	Low Battery Output
9		Output	12 VDC Power

Caution! Max rated values 12Vdc

USB Port (option)

Connecting the UPS to your computer may be accomplished through the USB port on the back of your computer. USB compliant hardware and operating system will be necessary including installation of a UPS driver. The serial port cannot be used when using the USB port. The USB cable is standard.

EPO Port (Emergency Power Off)

A customer-supplied switch located remotely can be used to open the EPO connection and allows UPS output receptacles to be switched off. Since the EPO shuts down the equipment immediately, orderly shutdown procedures are not followed. The UPS must be manually restarted in order to regain power to the outlets.

Network Transient Protector

The network transient protector, located on the back panel, has both IN and OUT jacks, and houses a single RJ-45 (10BaseT) network connector. Connect the input connector to the jack labeled IN, and the output connector to the jack labeled OUT.

Load Segments

The power management software controls the sets of receptacles known as load segments which provides organized shutdown and startup of the equipment. Less critical equipment can be turned off during power outages saving battery power for critical loads. The power management software manual has more details regarding this. The load group status can be viewed from the LCD display and can be changed if necessary. These load segments are usually handled with the UPS management software.

User's Guide To Operations

Necessary information for operation of the unit is covered in this chapter. Normally the UPS runs automatically, but for those few occasions such as just after installation, the starting and shutting down procedures are described herein.

Starting and Shutting Down the UPS

Starting the UPS

- Ensure that installation was correct and successful and that the input power cable is connected to a well-grounded outlet.
- The UPS can be started by pushing the  button on the front panel.
- The UPS should now start its inspection of: internal functions, mains synchronization and inverter startup. Then output power will be supplied via the outlets.
- During this inspection, the LCD will display "Ready on". The LED shall light up when output power has commenced and the LCD will display "Line mode".
- Switch on the loads.

Shutting down the UPS

- Shut down and turn off the loads.
- Push the  button on the front panel for three seconds. The alarm will sound and the UPS will shut down.
- The LCD will display UPS OFF for a few seconds.
- In emergency situations, the EPO located on the back of the unit should be used.

Button Operation

There are three operating buttons on the front panel.

1. ON / OFF BUTTON

- a. Push the ON / OFF BUTTON for at least 3 seconds to turn on the UPS
- b. Push the ON / OFF BUTTON for at least 5 seconds to turn the UPS off

2. ENTER BUTTON





- a. Push the ENTER BUTTON for at least 2 seconds to check content of the UPS. There are fifteen functions that can be checked.
- b. If you do not press the ENTER BUTTON within 10 seconds, the LCD will return to its original status.

3. FUNCTION BUTTON

- a. Push the FUNCTION BUTTON for at least 2 seconds to choose the function you'd like. Each setting will be displayed by pressing once, with fourteen functions that can be checked.
- b. After choosing the function, push the ENTER BUTTON to enter the function that you want.
- c. Push the FUNCTION BUTTON to choose other functions.
- d. Push the ENTER BUTTON to enable the function selected.
- e. Push the ENTER BUTTON again to confirm and fully enable the function.
- f. If the ENTER BUTTON is not pressed within 10 seconds, the UPS will return to its original status.

Control Panel Functions

Operation of the UPS is indicated on the monitor panel with five LED indicators and an LCD screen. This display is also capable of alerting the user with audible alarms.

ON / 	This LED is green when the UPS has been turned on and normal utility power is available.
ONLINE / 	This LED is green when the UPS is in normal or static bypass modes, and there is voltage at the output receptacles.
ON-BAT / 	This LED is red when the UPS is operating in battery mode.
BYPASS / 	This LED is yellow when the UPS is in bypass mode.
FAULT / 	This LED is red if any internal error occurs in the UPS. An audible alarm will also be present. Press any of the buttons on the front panel to silence the alarm.

Status of the UPS, measurements and alarms are all indicated on the LCD screen.

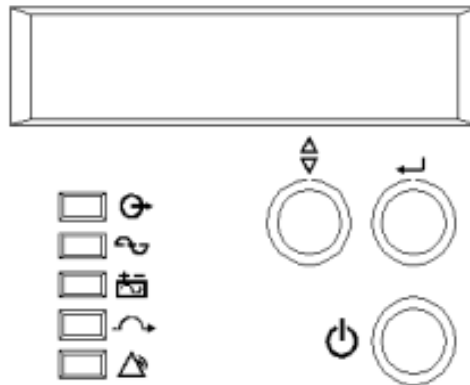

Control panel

Normal display







The UPS status is shown in normal display mode. From here you have a choice to go to UPS meters display and the Setting display by pushing the button.

UPS meters display

Various measurements are available through the UPS meters display; pressing the button will scroll through the following meters:

LCD message	Description
O/P VOLT= xxx, xV	Output AC voltage
O/P FREQ= xx, x Hz	Output Frequency
I/P VOL T= xxx, xV	Input AC voltage
I/P FREQ= xx, x Hz	Input Frequency
BAT VOLT= xx,xV	Battery Voltage
O/P LOAD%= xx%	Load % of max load
O/P W= xW	Output Watts
O/P VA= xVA	Output VA
O/P CURR= xA	Output Current
BACKUP TIME= xx min	Estimated Backup time in minutes
BAT CHARG= xx%	Approximate percentage of Battery capacity
TEMPERATURE= xxC	Approximate ambient temperature
BAT PACK NUM= x	External Battery Pack Number
RATING = xxxxVA	UPS Rating
CPU VERSION xx.x	CPU Version

UPS configurations

1. Various settings that have been chosen are shown in the UPS setting display.
2. To enter configuration mode, press the  button for one second. The first configuration parameter will be shown on the LCD display.
3. Press the  button to scroll through the parameters.
4. Press the  button to select the parameter.
5. Press the  button to scroll through the options for the selected parameter; Press the  button to select the option.
6. You may be prompted to save the selection, if so press the  button to either confirm or save your selection. Other options are saved and started automatically. See the table below for further details.
7. If no buttons are pressed (or user inactivity) for ten seconds, the UPS shall exit the configuration mode and return to normal mode displaying Line mode.

Caution!

The factory default settings do not necessarily have to be changed, although you are free to tailor the UPS to your specific needs.

Settings	LCD display	Explanation	Selection	Factory Default
Output Volt. Setting	O/P V Setting	Select Nominal Voltage	208/220/230/240V	230V
			100/110/115/127V	120V
Input/ Frequency	I/P F Setting	Select input frequency range when UPS goes into free run mode	±2% ±5% ±7%	±5%
Input/ Bypass Voltage	I/P Bypass Set	Select Input Voltage range when bypass is available	±10% +10/-15% +15/-20%	+10/-15%
Free Run Mode	Free Run Set	Select if UPS can run in Free run mode (unsynchronized)	ON/OFF	ON

Bypass Enable/ Disable at free run mode	Bypass disable	If Enable is chosen, the UPS can go to bypass when unsynchronized.	Disable/Enable	Disable
HE mode setting	HE Mode Set	Select if UPS runs in high efficiency mode	ON/OFF	OFF
Force Manual Bypass	Manual bypass	Permanently force UPS to bypass. For service only.**	ON/OFF	OFF
Management of load groups	Outlet Setting	You can put the two load groups on and off from front panel	1 ON & 2 ON 1 OFF & 2 ON 1 OFF & 2 OFF 1 ON & 2 OFF	Both load segments ON
Do Battery Test	Battery Test	Detect battery is normal or not.		
Silence Function	Silence Set	Enable or disable silence function	ON/OFF	OFF
Number of external battery Packs	Bat Cabinet Set	This setting is needed For UPS to predict backup time	0 (only internal batteries) 1(one external cabinet) 2 (two external cabinets)	0
Site wiring alarm	Sit Fault Set	You can enable or disable the site wiring alarm	Enable /Disable	Disable
Select language	Language	Select load language	English, German, French, Spanish, Italian.	English
Set Generator Mode	Generator	Set unit in generator mode. ***	ON/OFF	OFF
Set RS232 communication	RS232 Con- trol	Set RS232 communication enable or disable	Enable/Disable	Enable

Manual Test of UPS

A manual UPS or manual battery test can be conducted from the UPS configuration menu.

Manual Battery Test: Scroll the parameters until MANUAL BAT TEST displays on the LDC. Press the ENTER BUTTON twice.

Note: In order for the UPS and power management software to operate normally, MANUAL BYPASS should always be set to OFF as the load will not be protected by the UPS when MANUAL BYPASS is ON. The MANUAL BYPASS is intended to operate like an external maintenance bypass switch.

Note: The UPS should be turned OFF and initialized via AC power before using the GENERATOR MODE function.

Interpreting UPS Messages

Troubleshooting procedures described here give simple instructions in determining UPS malfunctions. Start the troubleshooting procedure if you witness any alarm indication on the control panel.

Alarm Indicators

- The UPS gives the following audible alarms:
- If UPS is on battery and the ON BATTERY LED is on, UPS will beep every 5 seconds.
- If the battery capacity is low and the ON BATTERY LED is flashing, the UPS will beep twice every 5 seconds.
- If UPS is on bypass and the BYPASSED LED is on, UPS will no beep.
- If UPS has an internal fault and the ALARM LED is on, the UPS will give a constant audible alarm displaying the cause on the LCD display.

Silencing an Alarm

By pressing any of the three buttons on the front panel, the alarm can be turned off, except when the battery is low, which will cause the alarm to resound.

On the LCD display, you can also choose silent alarm mode which will not warn you of any malfunction audibly.

Troubleshooting

Displayed on LCD	Audible Alarm	Alarm Description	What You Should Do
Output Overload	Two Beeps per second	The UPS is overloaded (in Line Mode). Your equipment needs more power than the UPS can provide. The UPS operates in bypass.	Shut off the least important equipment connected to the UPS. If this solves the overload problem, the UPS will switch from bypass back to normal operation.
Battery Test	No Beeps	The UPS is doing a battery test.	No action needed. The UPS will return to normal operation when it successfully completes the battery test.
Over-Charge	Constant beep	Batteries are overcharged.	Turn off protected loads. Turn off UPS and call your local dealer
Low Battery	2 beeps every 5 seconds	The unit is operating on Battery Power and will shut down soon due to very low battery voltage	The unit will restart Automatically when acceptable power returns.
On-Battery	Once every 5 seconds	The unit is operating on Battery Power.	Save your data and perform a controlled shutdown.
Charger Failure	Constant beep	Charger has failed.	Phone the local dealer
Over-Temperature	Constant beep	High ambient Temperature.	Make sure the unit's fans and vent holes are not blocked, and make sure the ambient surrounding temperature is not above 40 degree C. If these conditions did not solve the problem, call your service representative.
Output Short	Constant beep	Output short circuit	Call the Local dealer
High output Voltage	Constant beep	High output voltage	Call the Local dealer
Low Output Voltage	Constant beep	Low output voltage	Call the Local dealer
Bus Fault	2 Beeps per second	High internal DC bus Voltage.	Turn off protected loads. Turn off UPS and call your local dealer
Site wiring Fault	1 Beep per second	Voltage detected Between Neutral and Ground	UPS mains connector polarity Wrong. Rotate the connector (Schuko). UPS installed to mains supply without ground. See page 15 on how to disable the Site wiring alarm
Line abnormal	1 Beep per second	Wrong AC Line backed up during auto restart	

Maintenance

With a minimal amount of maintenance, you can expect the UPS to application, otherwise consider changing the batteries. have a long life free of trouble. The most critical issues for the reliability of the UPS are environmental issues. Ensure that the temperature and humidity are always according to specifications and keep the area around the unit clean and dust free.

At a temperature of 25°C, the typical battery lifetime is 4 years.

Replacing Batteries

The batteries may be replaced without having to turn the UPS off or disconnecting the load due to the hot swappable battery feature.

CAUTION! Read and follow the IMPORTANT SAFETY INSTRUCTIONS before servicing the battery. Service the battery under the supervision of Qualified Service Personnel knowledgeable of batteries and their precautions.

CAUTION! Use only the specified type of battery. See your dealer for replacement batteries.

CAUTION! The battery may present risk of electrical shock. Do not dispose of batteries in a fire as it may explode. Follow all local ordinances regarding proper disposal of batteries.

CAUTION! Do not open or mutilate the batteries. Released electrolyte is harmful to skin and eyes and may be toxic.

CAUTION! Although the battery voltage is only 12VDC, the battery can present a high risk of short circuit current and electrical shock. The short circuit current capability of the battery is sufficient to burn wire or tools very rapidly, producing molten metal. Observe these precautions when replacing the battery:

1. Remove all watches, rings or other metal objects.
2. Only use tools with insulated handles.
3. Do not lay tools or metal parts on top of battery or any terminals.
4. Wear protective eye wear (goggles), rubber gloves, and boots.
5. Disconnect the charging source before connecting or disconnecting the battery terminals.
6. Determine if the battery is inadvertently grounded. If inadvertently grounded, remove the source of the ground. Contact with a grounded battery can result in electrical shock! The likelihood of such shock will be reduced if such grounds are removed during installation and maintenance (applicable to a UPS and a remote battery supply not having a grounded circuit).

Replacing batteries (700 - 3000 VA)

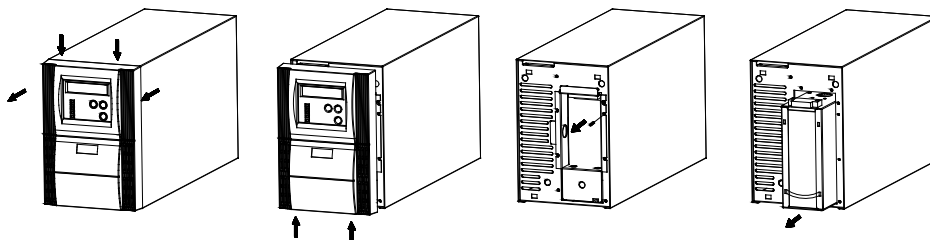

The following is a step-by-step tutorial for replacing the batteries:

1. The front panel of the UPS can be removed by pushing where the arrows indicate in the pictures above. Next, unscrew the screws and remove the metal battery cover.
2. Remove the battery cartridge from the UPS. The voltage in all models will be less than 48Vdc once the battery is disconnected from the UPS.
3. Replace the batteries.
4. Push the cartridge with the new batteries back into the UPS.
5. Reinstall the metal plate and the front panel.

Technical Specifications

MODEL NUMBER		T90-700	T90-1000	T90-1500*	T90-2000	T90-3000	T90i-1500	
INPUT	Capacity	700VA (490W)	1000VA (700W)	1500VA (1050W)	2000VA (1400W)	3000VA (2100W)	1500VA (1050W)	
	Voltage range	60–144VAC**					120–276VAC**	
	Frequency	50/60Hz auto sensing						
OUTPUT	Voltage	120VAC nominal (100/110/115/127VAC selectable)***					208/220/ 230/240VAC	
	Waveform	Sine wave, zero transfer time						
	Frequency	50/60Hz auto sensing ≤ 1%						
	Load segments	Two controlled via software						
	Load power factor	0.7						
	Efficiency	High efficiency > 95%, normal mode > 90%						
	Overload capacity	125% for 1 min, 150% for 10 sec						
BATTERY	Battery type	(2) 12V 7.2AH	(3) 12V 7.2AH	(3) 12V 9AH	(6) 12V 7.2AH	(6) 12V 9AH	(3) 12V 9AH	
	Recharge	4 hours to 90% capacity						
PHYSICAL	UPS dimensions (W x D x H)	6.0 x 16.5 x 9.5 in			8.9 x 16.5 x 14.2 in		6.0 x 16.5 x 9.5 in	
	UPS weight	31 lbs	38 lbs	39 lbs	73 lbs	78 lbs	39 lbs	
	Line cord	5–15P*			5–20P	L5–30P	IEC C14 inlet	
	Receptacles	(6) NEMA 5–15R*			(12) NEMA 5–15/20R	(10) NEMA 5–15R + (1) L5–30R	(4) IEC C13	
	LCD display	Input/output voltage, input/output frequency, online mode, backup mode, battery capacity, load level						
OPTIONAL BATTERY PACKS	Model number	N/A	T90-BP/T90-BP1		T90-BP2		T90-BP/T90-BP1	
	Dimensions (W x D x H)	N/A	BP – 6.0 x 16.5 x 9.5 in; BP1/BP2 – 8.9 x 16.7 x 14.2 in					
	Weight	N/A	BP = 46 lbs; BP1/BP2 = 88 lbs					
	Battery type	N/A	T90-BP – 2 x (3) 12V 7.2AH; T90-BP1 – 4 x (3) 12V 7.2AH; T90-BP2 – 2 x (6) 12V 7.2AH					
ENVIRONMENT	Temperature	32–104°F (0–40°C)						
	Audible noise	< 40 dBA						
	Altitude	11,500 ft above sea level						
APPROVALS	UL, cUL, FCC, CE							
WARRANTY	3 years electronics, 3 years battery warranty (USA and Canada)							
COMMUNICATIONS INTERFACE	RS-232, USB, EPO, intelligent slot for optional cards (Web/SNMP, Relay/dry contact)							
INCLUDED IN BOX	User manual, monitoring software, CD, USB cable							
AVAILABLE OPTIONS	Extended warranty, bypass distribution (XBDM), power distribution (XPDU)							

*T90-15HW 1500VA model available with input and output terminal blocks

**Depending on load level

***T90 capacity derates 10% at 110VAC and 20% at 100VAC output voltage

Terminal Block

Please refer to the terminal block connection diagram to connect and use No. 14 AWG, 90°C copper wire and 8 lb-in torque force when connecting.

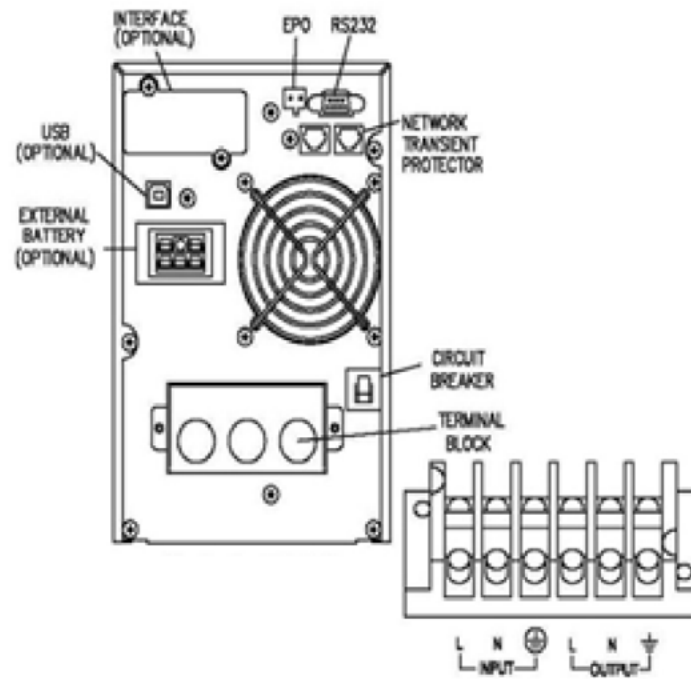

Obtaining Service

If the UPS requires Service:

1. Use the TROUBLESHOOTING section in this manual to eliminate obvious causes.
2. Verify there are no circuit breakers tripped.
3. Call your dealer for assistance. If you cannot reach your dealer, or if they cannot resolve the problem, call Xtreme Power Conversion Corp Technical Support at 800.582.4524. Technical support inquiries can also be made at support@xpcc.com. Please have the following information available BEFORE calling the Technical Support Department:
 - Your name and address.
 - The serial number of the unit.
 - Where and when the unit was purchased.
 - All of the model information about your UPS.
 - Any information on the failure, including LED's that may or may not be illuminated.
 - A description of the protected equipment, including model numbers if possible.
 - A technician will ask you for the above information and, if possible, help solve your problem over the phone. In the event that the unit requires factory service, the technician will issue you a Return Material Authorization number (RMA).

If you are returning the UPS to Xtreme Power for service, please follow these procedures:

1. Pack the UPS in its original packaging. If the original packaging is no longer available, ask the Technical Support Technician about obtaining a replacement set of packaging material. It is important to pack the UPS properly in order to avoid damage in transit. Never use Styrofoam beads for a packing material.
2. Include a letter with your name, address, daytime phone number, RMA number, a copy of your original sales receipt, and a brief description of the problem.
3. Mark the RMA number on the outside of all packages. Xtreme Power cannot accept any package without the RMA number marked on the outside of the boxes.
4. Return the UPS by insured, prepaid carrier to the address provided by the Technician.
5. Refer to the Warranty statements in this manual for additional details on what is covered.

Xtreme Power Conversion Limited Warranty

Xtreme Power Conversion (XPC) Corporation warrants Xtreme Power Conversion equipment, when properly applied and operated within specified conditions, against faulty materials or workmanship for a period of **three years for T90-Series products** from the date of purchase. XPC Corporation warrants **internal batteries for a period of three years** from the date of purchase. For equipment sites within the United States and Canada, this warranty covers repair or replacement, at the sole discretion of XPC Corporation. The customer is responsible for the costs of shipping the defective product to XPC Corporation. XPC Corporation will pay for ground shipment of the repaired or replacement product. This warranty applies only to the original purchaser.

If equipment provided by XPC Corporation is found to be **Dead-on-Arrival (DOA)**, XPC Corporation will be responsible for the costs of shipping product to and returning equipment from the customer in a timely manner as agreed to with the customer, once the customer has requested and received a **Return Material Authorization (RMA)** number. DOA equipment is defined as equipment that does not properly function according to user documentation when initially received and connected in conjunction with proper procedures as shown in the user documentation or via support provided by XPC Corporation personnel or authorized agents.

This warranty shall be void if (a) the equipment is repaired or modified by anyone other than XPC Corporation or a XPC Corporation approved third party; (b) the equipment is damaged by the customer, is improperly used or stored, is subjected to an adverse operating environment, or is operated outside the limits of its electrical specifications; or (c) the equipment has been used or stored in a manner contrary to the equipment's operating manual, intended use or other written instructions. Any technical advice furnished by XPC Corporation or a XPC Corporation authorized representative before or after delivery with regard to the use or application of Xtreme Power Conversion equipment is furnished on the basis that it represents XPC Corporations best judgment under the situation and circumstances, but it is used at the recipient's sole risk.

EXCEPT AS STATED ABOVE, XPC Corporation DISCLAIMS ALL WARRANTIES, EXPRESSED OR IMPLIED, INCLUDING WARRANTIES OF MERCHANTABILITY AND FITNESS FOR A PARTICULAR PURPOSE.

EXCEPT AS STATED ABOVE, IN NO EVENT WILL XPC Corporation BE LIABLE FOR DIRECT, INDIRECT, SPECIAL, INCIDENTAL, OR CONSEQUENTIAL DAMAGES ARISING OUT OF THE USE OF Xtreme Power Conversion EQUIPMENT, including but not limited to, any costs, lost profits or revenue, loss of equipment, loss of use of equipment, loss of software, loss of data, cost of substitutes, or claims by third parties. Purchaser's sole and exclusive remedy for breach of any warranty, expressed or implied, concerning Xtreme Power Conversion equipment, and the only obligation of XPC Corporation under this warranty, shall be the repair or replacement of defective equipment, components, or parts; or, at XPC Corporations sole discretion, refund of the purchase price or substitution of an equivalent replacement product.

Xtreme Power Conversion Load Protection Policy

THIS POLICY IS NOT A WARRANTY. REFER TO **THE XPC CORPORATION, INC. LIMITED WARRANTY** FOR INFORMATION CONCERNING THE WARRANTY FOR YOUR XPC PRODUCT. THE LIMITATIONS AND CONDITIONS CONTAINED IN THIS POLICY DO NOT AFFECT **THE TERMS OF THE XPC LIMITED WARRANTY**.

Definitions:

1. "Product" means a Standard 120, 208, or 240 Volt power protection device that is used in the United States and Canada. This policy does not include custom manufactured products.
2. "Power Disturbance" means an AC power line transient (telephone line or Local Area Network, if applicable), spike or surge.
3. "Connected Equipment" properly connected electronic equipment
4. "Fair Market Value" of damaged Connected Equipment as determined by XPC shall be the lower of (a) the average price the same or similar items are being sold for on eBay, (b) the price list of Orion Blue Book (or if such price list is no longer published, a published or announced price list reasonably selected by XPC), (c) the lowest price the same or similar items can be purchased for in the United States or (d) the total amount of all payment(s) you have or are entitled to receive from insurance, other warranties, extended warranties, a legal liability claim or from other sources or persons for the damaged Connected Equipment.
5. "Purchaser" means the person or entity that originally purchased the Product from an authorized reseller or distributor of XPC Products.

The Purchaser of this Product is protected, for the term of the XPC Limited Warranty, against certain losses caused by a Power Disturbance for properly connected electronic equipment (referred to as the "Connected Equipment") subject to certain terms and conditions provided below.

This policy applies only to the original purchaser of the Product. If the Product is transferred or sold to another person or entity, this policy is void.

Load Protection Policy Dollar and Period Limits

For purchasers that meet the qualifications and conditions set forth in this policy, XPC will provide reimbursement (cost of repair or fair market value as determined by XPC) during the period limits and up to the dollar limits stated as follows:

PRODUCT	DOLLAR LIMIT	PERIOD OF COVERAGE
XVT	25,000	Term of XPC Limited Warranty
XST	25,000	Term of XPC Limited Warranty
S70	25,000	Term of XPC Limited Warranty
XPRT 6kVA & 10kVA	50,000	Term of XPC Limited Warranty
NXRT	50,000	Term of XPC Limited Warranty
P90, P90L, P90g, P90Lg	50,000	Term of XPC Limited Warranty
T90	50,000	Term of XPC Limited Warranty
TX90, TX90i	50,000	Term of XPC Limited Warranty

This Load Protection Policy is not deemed "first dollar" coverage. XPC's obligation is reduced by any amounts that the Purchaser is entitled to recover, from other sources regarding the Connected Equipment, including, but not limited to, insurance, other warranty, extended warranty, or legal liability, regardless of whether or not the Purchaser makes a claim for recovery.

Eligibility for Coverage Under the Load Protection Policy

1. The Product must be registered on the XPC website, www.xpcc.com, within 10 days of purchase. All required information must be provided, and Purchaser should retain a copy for Purchaser's records. When registering on the website, Purchaser must list all connected equipment that is directly connected to the

- product. Only those devices registered in that manner will be covered.
2. All Connected Equipment must be UL or CSA approved.
 3. The Product must be plugged into a properly wired and grounded outlet. Use of input surge devices, extension cords, adapters, ground wires, or electrical connections not manufactured by XPC voids the XPC Load Protection Policy. No other surge protection device may be connected to the output sockets of the Product. The installation must comply with all applicable electrical and safety codes set forth pursuant to the NEC.
 4. The Product must have undeniable physical evidence of a Power Disturbance that directly and proximately caused the damage;
 5. The Connected Equipment must have been damaged by a Power Disturbance on a properly installed, grounded, and National Electric Code, ("NEC"), code-compliant 120, 208, 240 Volt AC power line in the United States or Canada, by a Power Disturbance on standard telephone land line or PBX telephone equipment line that is properly installed and connected to an RJ11 port on the Product; or by a Power Disturbance on a standard Local Area Network connection that is properly installed and connected to an RJ45 port on the Product and (d) is directly plugged into, and properly connected to, the Product in its original condition which was properly operated when a Power Disturbance passed through the Product and (i) exhausts the protection capacity of the Product or (ii) damages the Product.
 6. The Load Protection Policy does not apply if the Product has been operated in a failure mode or not in compliance with XPC operating instructions in the Product user's manual, or if the Connected Equipment has not been operated in compliance with the instructions and manuals of its manufacturer/vendor.
 7. This policy is null and void if, XPC determines, in its sole discretion, that the Product has been tampered with or altered in any way.

What is Not Covered Under the Load Protection Policy:

The following damage is not covered by this Policy:

1. Restoration of lost data and reinstallation of software.
2. Damage from a cause other than AC power-line transients, except for damage due to telephone line, Local Area Network, or CATV transients, which is covered only if the Product offers such protection.
3. DAMAGE CAUSED BY FAILURE TO PROVIDE A SUITABLE INSTALLATION ENVIRONMENT FOR THE PRODUCT (INCLUDING, BUT NOT LIMITED TO, LACK OF A PROPER SAFETY GROUND).
4. Damage caused by the use of the Product for purposes other than those for which it was designed.
5. Damage caused by accidents, or natural disasters, including but not limited to, fire, flood, and wind.
6. Damage caused by abuse, misuse, alteration, modification, or negligence.
7. Any labor costs or travel, room and board expenses associated with the repair and/or restoration of lost or damaged hardware, software or data.

EXCEPT AS EXPRESSLY PROVIDED IN THIS POLICY, XPC SHALL NOT BE LIABLE FOR ANY DAMAGES WHATSOEVER, INCLUDING, BUT NOT LIMITED TO, DIRECT, INDIRECT, SPECIAL, INCIDENTAL, CONSEQUENTIAL, OR MULTIPLE DAMAGES ARISING OUT OF THE USE OF THE PRODUCT OR DAMAGE TO THE CONNECTED EQUIPMENT, REGARDLESS OF THE LEGAL THEORY ON WHICH SUCH CLAIM IS BASED, EVEN IF ADVISED OF THE POSSIBILITY OF SUCH DAMAGE. SUCH DAMAGES INCLUDE, BUT ARE NOT LIMITED TO, LOSS OF PROFITS, LOSS OF SAVINGS OR REVENUE, LOSS OF USE OF THE PRODUCT OR THE CONNECTED EQUIPMENT OR ANY ASSOCIATED EQUIPMENT, LOSS OF SOFTWARE, COST OF CAPITAL, COST OF ANY SUBSTITUTE EQUIPMENT, FACILITIES OR SERVICES, DOWNTIME, THE CLAIMS OF THIRD PARTIES, INCLUDING CUSTOMERS, AND INJURY TO PROPERTY.

Submitting a Load Protection Policy Claim:

1. Any claim under the Load Protection Policy must be made within 10 days of the date of alleged damage to the Connected Equipment.
2. Call the XPC technical support department at 1-800- 582-4524 and obtain a Load Protection Policy Returned Material Authorization (RMA) number. Have information on all applicable insurance or other resources of recovery/payment that is available to the Purchaser and the name of the power utility supplier for the location of the Connected Equipment. XPC will forward to the Purchaser a Load Protection Policy claims form, which

must be completed and filed with XPC within 30 days.

- Mark the Load Protection Policy RMA number on the Product the Purchaser is returning.
- Pack the Product in its original packaging or similar packing materials if the original packaging has been discarded. Enclose the completed Load Protection Policy claim form and a copy of the Purchaser's original sales receipt for the Product in the box.
- Mark the RMA number clearly on the outside of the box.
- Ship the Product (one-way shipping charges paid by the Purchaser) to:

XPC Corporation
230 Yuma Street
Denver, CO 80223
Attn: LPP RMA#

3. XPC will evaluate the Product to determine its level of functionality, and will examine the Product for evidence of damage from a Power Disturbance.
 - If XPCs' evaluation provides no evidence of damage from a Power Disturbance, XPC will send to the Purchaser (i) a report summarizing the tests performed and (ii) a rejection of claim notice.
 - If the Product shows evidence of damage from a Power Disturbance, XPC will request that all Connected Equipment for which a Load Protection Policy claim has been submitted, be sent for evaluation to either XPC or an authorized service center. If it is determined that the Connected Equipment has been damaged by a Power Disturbance, XPC will, in its sole discretion, issue payment to the Purchaser for either the cost of repair of the Connected Equipment or the Fair Market Value of the damaged Connected Equipment, up to the dollar limits stated above. XPC reserves the right to require the Purchaser to transfer title and deliver the Connected Equipment to XPC if it chooses to reimburse the Purchaser for the fair market value of the Connected Equipment. XPCs' maximum liability shall be reduced to reflect all such other payments or sources of recovery, whether applied for or not.
4. If XPC issues payment to the Purchaser to have the Connected Equipment repaired, the repair must be performed at a service center that is authorized by the manufacturer of the Connected Equipment. XPC reserves the right to contact the authorized service center directly to discuss repair costs and damage to the Connected Equipment to determine if it was caused by a Power Disturbance and the right to request that the service center forward the Connected Equipment or components of the Connected Equipment to XPC for inspection
5. Unless modified in writing signed by an officer of XPC and the Purchaser, the terms of this policy are the complete and exclusive agreement between the parties, superseding all prior agreements, oral or written, and all other communications between the parties relating to the subject matter of this agreement. No employee of XPC or any other party is authorized to make any representations beyond those made in this agreement concerning the Load Protection Policy.

XPC Corporation
230 Yuma Street
Denver, CO 80223
1.800.582.4524