



SPD-0215 Switched PDU

15A Model

User & Installation Manual

Table of Contents

System Description.....	3
Front and Back Panel.....	4
Important Safety Precautions for Hardware Installation.....	5
Safety Precautions.....	5
Battery Replacement.....	6
Access to the System.....	6
Factory Default Settings.....	6
User Privileges and Port Reservations.....	6
Local Master Port Access.....	7
External Modem Access.....	7
Telnet Access.....	7
Web Access.....	8
Email Access.....	9
SNMP Information.....	10
AutoPing and Power Reboot.....	11
Using Control Command.....	11
Using Configuration Menu.....	13
Starting Configuration Menu.....	13
Viewing and Changing Operation Status.....	13
Power Outlet Setup Menu.....	14
Power Outlet Timer Setup Menu.....	15
User Account Setup Menu.....	17
System Access Setup Menu.....	18
Serial Port Setup Menu.....	19
TCP/IP Network Configuration Menu.....	21
More About TCP/IP Network Configuration.....	23
More about Emailing Access.....	24
Appendix A: Serial Console Port Interfaces.....	25

System Description

MODEL NUMBER	SPD-0215
Power cords	1
Power outlets	2
Power input	IEC C14 inlet
Outlet type	(2) NEMA 5–15R
Input current	15A
Input voltage	120VAC
Dimensions (W x D x H)	5.4 x 6.0 x 2.5 in
Console port	Baud rate: 115200; 8 data bits; no parity; 1 stop bit; no hardware handshaking
Ethernet	10/100 Base-T
Network protocol	ICMP, IP, TCP, DHCP, Telnet, DNS, POP3/SMTP, SNMP, HTTP, and BootP
Display	(6) LEDs
Operating temperature	32°F–122°F (0°C–50°C)
Storage temperature	-20°F–140°F (-29°C–60°C)
Humidity	10–90%
WARRANTY	2 years (USA and Canada)

Model No.	Total Outlets	Input Voltage	Input Feeds	Max.Load per Group	Max.Load per Unit
SPD-0215	2	100-120VAC	(1 ea.) 15 Amp	15 Amps	15 Amps

Key features include:

- **Local Master Port access:** offers data rates from 2400 to 115200 bits/second and optional hardware handshaking (CTS/RTS). There are two operation modes for the port: Console Transparent and System Control.
- **Three user privilege login levels:** The Administration level manages system configuration and unconditional access to all power outlets and all serial ports. The User level allows each user to reserve and manage his/her own ports, as well as to change the most of system configuration settings. Anonymous users are able to view all settings and operate unreserved power outlets and serial console ports.
- **User name and password for each port:** The user name and password are protected in each ports.
- **Line commands or menu configuration controls:** Menu table operation offers user-friendly operation methods that are used for changing system configurations, viewing run time statuses, and issuing controls. Line commands provide quick and easy operations.
- **Telnet access:** Remote access the system over a TCP/IP network for configuration and systems control.
- **Out of band Modem access interfacing:** Control and configure the system via a telephone line. Optional custom Modem AT command string to the Modem.
- **HTTP web access:** Embedded web server provides secured user name and password authentication. The operations are easy and friendly, utilizing tables and graphical icons. Download SNMP MIB files conveniently, or view the help manual on line.
- **SNMP MIB capability:** An SNMP(Simple Network Management Protocol) agent is integrated in the system for an exchange of management information between the system and network devices.
- **POP/SMTP Emailing with SMTP Authentication capability:** A user can send control commands such as reboot power outlet via emails. Command execution reports are replied for each command email received. SMTP user name and password are protected through authentication process.
- **SNMP Trap for sending logging message:** The Trap is used to asynchronously report events to the NMS. It forwards power reboot command execution information to the remote Trap logging receiver.

What you can do with the system:

- **Remote equipment power source management over TCP/IP networks,** including user equipment rebooting, and permanently user power source turn on/off. Schedule power reboots or power source on/off

events monthly, weekly, daily or at any time. Reboot power source to equipment when a network connection is lost.

- **Monitoring AC Power Consumptions** and sending warning messages when the aggregated AC draw from a system is crossed predefined threshold.
- **Remote control anywhere by emailing.** Via emails, you are able to manage the systems or user communication equipment power sources when LAN access is impossible. Via emails, you can send user data to the NP control commands such as rebooting user power source. Reply emails are sent after the system intercepts incoming emails so that you are informed with the operation status.
- **AutoPing and reboot user equipment.** Connect your system to a power outlet and assign the system network IP address or URL. The NP system will ping the user equipment Periodically (in every 15 seconds). If the user equipment stops responding the ping request, the equipment will reboot the power.
- **Scheduling AC outlet power cycling periodically or per weekly planner.** Each outlet can be programmed with it's own timer.

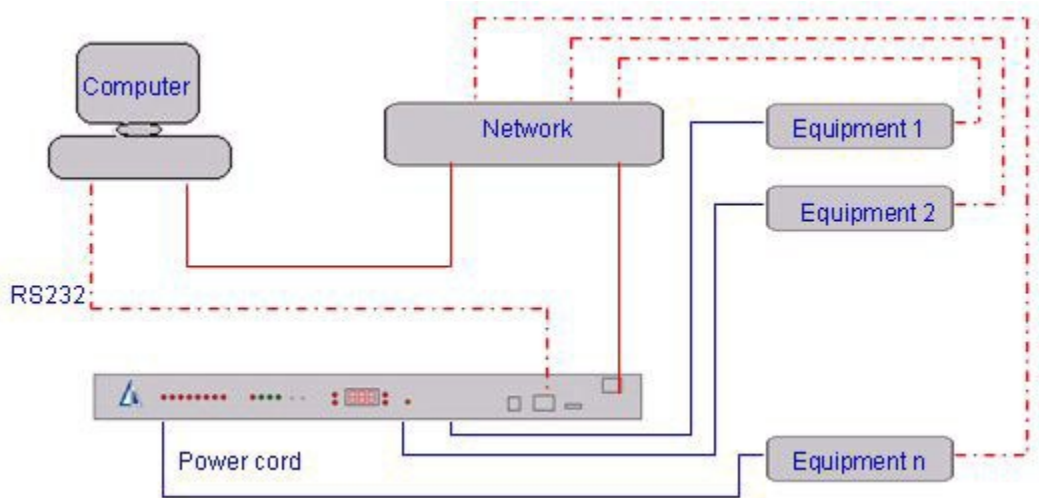
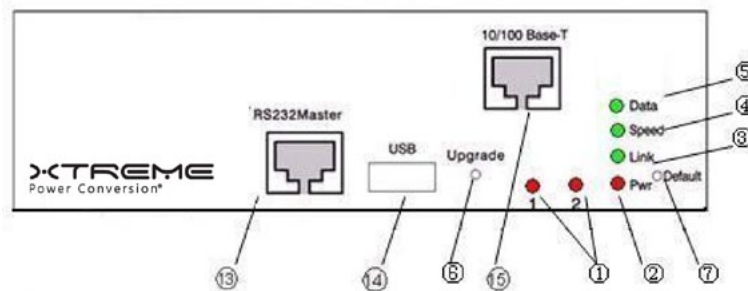
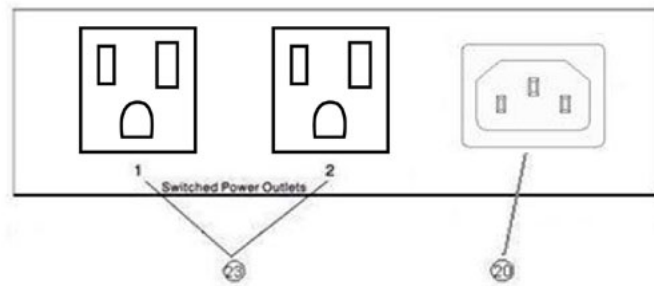

Illustration of Typical Application

Front and Back Panel



SPD-0215 Front Panel



SPD-0215 Back Panel

1. Power Outlet status LED: Visual indication of user power outlet On/Off status.
2. System power On/Off status LED: Indication of system power On/Off status.
3. Ethernet Link status LED: When the LED is illuminated, Ethernet port and a LAN connection are established.
4. Ethernet speed status LED: Ethernet port have 100M status.
5. Ethernet Active data status LED: When there is data traffic on the LAN, the LED is illuminated.
6. Factory Upgrade switch: Allow the user to upgrade the system. The switch is located behind the small front panel opening.
7. Factory Default Reset switch: Allow a user to reset the system to factory default settings. The switch is located behind the small front panel opening.
13. Local Master Port (DCE, 9 pin DB, female, or RJ-45 socket): This is also a service port for the user to configure and change system operation settings.
14. USB Port: For software upgrade.
15. Ethernet Port (RJ45, 10/100 Base-T): 10/100 Based-T Ethernet port for connection to LAN.
20. Power Circuit A - Power Inlet: An IEC C14 AC inlet which supplies power.
23. Power Circuit A - Switched Outlets: AC Outlets that can be switched On, Off or rebooted in response.

Caution: Sensor interface can be connected only with the sensor provided by the manufacture (Do not connect a telephone line and so on).

Important Safety Precautions for Hardware Installation

Safety Precautions

It is important that you read this section before attempting any of the hardware installation and maintenance procedures in this guide.

The following instructions are important for your safety and for the function of the unit. Read the instructions carefully before the installation

WARNING!

To reduce the risk of fire or electrical shock, never remove the cover of the unit. No user serviceable parts inside. Repair should be done by authorized service personnel only. The unit should be installed in indoors with ambient temperature and sufficient airflow.

WARNING!

Please ensure the hardware to be disconnected with power supply for installation. It means that the unit's power cable and network cables must remain disconnection until you are instructed to make the connections. Follow the instructions in the procedures carefully. This equipment is requested to be disconnected from the power supply by removing the power cord(s) from the power outlet. It is therefore important to locate the unit close to a power outlet that is easily accessible.

WARNING!

To be safe, the unit must have the ground protection.

Battery Replacement

A 3.0V Lithium recharging battery is installed in the unit for internal Real-Time Clock and system data retention. The battery should last recharging 1000,000 times at least. If the battery needs to be replaced, please ask authorized service personnel to do so.

Access to the System**Factory Default Settings**

The system is shipped with Factory Default settings. The default settings for the Local Master serial port are: **115200, 8 data bits, no parity, 1 stop bit, and no hardware handshaking (Flow Control)**.

The default Ethernet setting are: **IP:192.168.1.100, GateWay:192.168.1.1, NetMask: 255.255.255.0**

The default Administrator's login name "**admin**" and the default password is "**admin**" and user's login name "**user**" and the default password is "**user**". All existing user accounts are erased if the system is recovered to the default settings. The default SNMP Community string for public, private and Trap access is "**public**".

There are two ways to restore the system to the Factory Default settings. The first method is to press a push-button switch located on the front panel for 1 second. The second method is to select "Set Default Factory" from the Main Menu. The Main Menu can be viewed by running a terminal emulation program such as Window's Hyper Terminal.

```

Serial-COM4 - SecureCRT
文件(F) 编辑(E) 查看(V) 选项(O) 传输(T) 脚本(S) 工具(L) 帮助(H)
Serial-COM4
hello world
*****
*                                     *
*                               WELCOME *
*                                     *
*       Remote Control Power System: NP-02U *
*                                     *
*               Build Jul 15 2010 16:13:46 *
*                                     *
*****
Configuring network interface ...
Waiting for lwip init ...
ethernet Link now 100 FullDuplex
Using static configuration:
Ipaddr: 192.168.1.100
Netmask: 255.255.255.0
Gateway: 192.168.1.1
DNS Server Set to : Primary DNS 211.161.46.84, Secondary DNS 211.161.46.85
> login
enter user name:admin
enter password:admin
login success
>
就绪      Serial: COM4      24, 3      24行, 93列      VT100

```

System Startup Screen

User Privileges and Port Reservations

All user levels, including anonymous (visitor), are able to access the system via a serial connection from your work station to the Local Master port, or via a Telnet session from your work station

Administration Login:

There is 8 Administration account at most on the system. The default name is "admin" and default password is also "admin". The default name and password may be changed. If you login at Administration level, you are able to remove or change existing user accounts, take over power outlets or user serial console ports and change system settings.

User Login:

At user login level, you are able to reserve power or console ports for your applications if they are "open", as well as make system configuration changes. At this login level, you are not able to change power outlet operation status for other reserved power outlets.

Guest (Visitor) Access:

At user guest level (as an visitor user), you are only able to view the system configuration settings and operate unreserved power outlets.

Local Master Port Access

To access and configure the system from the master port, you need to connect a RS232 port from your work station to the Local Master Serial Port. Then run a terminal emulation program (such as Window's Hyper Terminal) on your computer.

1. Connect the system's Local Master Port (DCE) with a straight DB-9 type cable, if your work station is equipped with a DTE part.
2. Connect the system's Ethernet port to your LAN, if you intend to use the network port.
3. Turn the system power on.
4. At the terminal emulation program, type the "help" for help information.
5. The system has DHCP enabled, as a default setting. Network connectivity parameters displayed at the startup screen. If the system does not get a DHCP offer, the system falls back to default static network settings. You can alter the default network settings to fit your need.
6. Use the command "ping" to verify your connection. If a network connection is established, you are able to use Telnet, Web Browsing, Emailing and SNMP.

External Modem Access

With this access method, an RS232 port on an external Modem device is connected to the Local Master Port. Typically, a Modem device is equipped with a DCE (Data Communication Equipment) terminal connector. Since the system's Local Master Port and Modem device ports are not complementary (both are DCE ports); you need to use a NULL Modem cable with both male connectors.

Telnet Access

Operation of on a Telnet terminal is almost identical to the access method via Local Master Serial Port. You need to make sure that Telnet access is enabled, as a default setting. If the access is not enabled, please refer to Section "Using Configuration Menu" to change the setting.

Before you start the Telnet application, the user need to obtain the actual IP address for the system. The system displays network connectivity information at system startup terminal when your workstation is connected to the system's Local Master Serial Port. Please refer to "TCP/IP Network Configuration" section of this document for information on how to setup the network parameters.

Once the network connection is established, at your workstation prompt, you need to enter:

telnet ip_addr

You need to set a Telnet session on your workstation to Local Echo Off mode.

Telnet session permits an anonymous user who may only to view the system settings and operate unreserved power outlets and user serial console ports. Please refer to "User Privileges and Port Reservations" for further information.

- There are 8 Telnet session at most may be active at the same time.
- A Telnet session remains active for 10 minutes if it is in idle state.
- Telnet access methods can be enabled or disabled using the System Access Setup Menu.
- To terminate an active Telnet session, use the command "exit" at the terminal.



```
C:\ Telnet 192.168.1.100
*****
*                                     *
*                               WELCOME                               *
*                                     *
*       Remote Control Power System: NP-02U                          *
*                                     *
*             Build Jul 15 2010 16:13:46                              *
*                                     *
*****
> login
enter user name:admin
enter password:admin
login success
> _
```

Telnet Session Startup Screen

Web Access

You need to obtain the system IP address before starting web access to the system. Please refer to the Telnet Access section for methods to get the system IP address. You also need to make sure that web access is enabled, as a default setting. If the access is not enabled, please refer to Section "Using Configuration Menu" to change the setting. Start a Web browsing application program such as Window's Explorer and enter "http://ip_address" in the address field.

You must have an account on the system in order to access the system via this method. Without a valid account, you are only able to view the following web page and get a copy of the Help text message.



XPC CORPORATION

USER: admin

SYSTEM: SPD-0215

- System Status
- Power Outlet Setup
- Outlet Timer Setup
- User Account Setup
- System Control
- Serial Port Setup
- Network Setup
- Alarm Setup
- Help

System Operation Status

C-A:0.00A

Power Outlets					
Port #	On/Off	Reboot	Status	Port Name	Reservation
1				Outlet 1	Open
2				Outlet 2	Open

Reboot duration is 5 seconds.

Web Access Startup Page

Upon clicking the Login button, a secured login table is displayed at you work station. Factory default setting for user name is "admin". The default password is "admin".



Web Access Login Entry Table

Email Access

To establish this access method, the system's network connection is already established. With the email access method, you are able to execute the NP system controlling commands. The NP system periodically checks incoming mails from a designated POP mail server. The system sends a reply email with command process status if an email is intercepted.

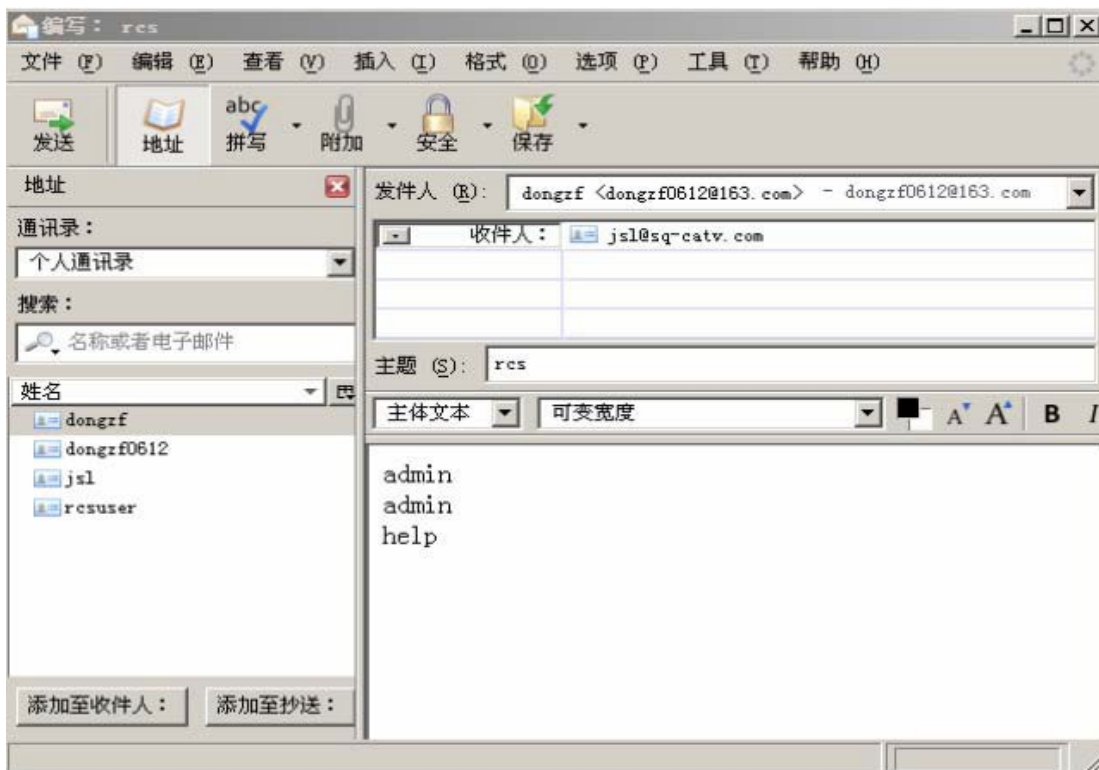

Sending Command from Hotmail Web Site

SNMP Information

Applications such as an NMS (Network Management System) or an SNMP browser can exchange information with the NP systems. SNMP is disabled with the default setting.

The information managed by an SNMP daemon on the system can be obtained using SNMP requests from a remote work station. An SNMP Get/Get Next request fetches the value of a single variable or a set of variables. An SNMP Set request modifies the value of a variable.

You need to know the name of a variable before you can fetch or modify a variable's value. A variable's symbolic name is mapped to a numeric name, which is referred as *OID*.

The MIB (Management Information Base) is a text file describing the internal objects the SNMP agent can display, monitor, and/or modify. Each MIB object is the system variable that has name and an *OID*. You need the MIB file to properly configure the SNMP client ("manager") for server monitoring. To get a copy of the MIB file, please use a web browser to access the NP systems. Open the TCP/IP Network Configuration Menu and then click the button "Get SNMP MIB File" to download the MIB file that is stored in the system's memory.

Enterprise OID: 1.3.6.1.4.1.32287

Definition	OID	Returned message
devName	.1.1	The system name or site name. Read only.
devType	.1.2	The system model type. Read only.
sysCurrentA	.1.3	First AC current monitoring reading. For a system equipped with single power cord, this the valid current reading. For dual power corded system, this is the first part of the AC current reading. Read only.
sysCurrentB	.1.4	For dual power corded system, this is the AC current reading for the second power inlet (or power cord). Read only.
sysTemp	.1.5	The system temperature, this is only available when the temperature sensor is installed. Read only.

AutoPing and Power Reboot

Each power outlet has optional settings that a NP system uses to ping network equipment. The pinged equipment is attached to a specific power outlet. It reboots user equipment power source if a network connection is not detected any more. However, user equipment never gets power reboot if the equipment never replies ping reply to a NP system.

A power outlet has the optional settings (Power Outlet Setup Menu) that specify the destination IP address that the system will ping periodically, and maximum network downtime allowed. In addition, to avoid unwanted reboots, a NP system also pings the gateway IP address (as default) to make sure a NP system has a network connection that is still active. Otherwise, AutoPing will be in off mode if a NP system lost network connection. To change the default gateway IP address as ping destination, use TCP/IP Configuration Menu to enter your desired destination address.

Using Control Command

A NP system provides command line options for viewing or changing system configuration and operation status. In addition, by using the control command option, users are able to create script files for automation of equipment test and control.

Control commands are applicable to the connections between your work station and Local Master Serial Port or a Telnet session.

Some of the control commands are also applicable to emails. See related sections for more detailed information about how to setup email accounts.

Once the system starts or a Telnet session is open, you are ready to send control command to the system. Type command "help" to have a complete list of available commands.

All login levels including anonymous users are able to use the command line option. However, the actual command executions are based on your login level. For example, if you are an anonymous user, you are not able to reserve or un-reserve serial console ports or power outlets. If you login at Administration level, you are able to operate any serial ports and power outlets, reserve or unreserved any ports or outlets even if they are reserved by other users.

```

*****
*                                                                 *
*                                                                 *
*      Help Menu                                                *
*                                                                 *
*                                                                 *
*****
**NOTE : command marked with * need user permission
**NOTE : command marked with # need admin permission
login                login
logout              logout
whoami              who am i?
#ul                 show userlist
ver                 show the hw/sw version
date                print current date
time                print current time
temp                read temperature sensor
cura                read current sensor a
curb                read current sensor b
#ssn 0x12345678     set serial num
ssh                Displays console ports configuration status
#reinit             set default factorys (need reboot)
pshow              Displays power outlet status
ptshow             Displays power outlet timer information.
*pset n v           Sets power outlet #n to v(value 1-on, 0-off)
*ps v              Sets all power outlets to v(value 1-on, 0-off)
*prb n             Reboot power outlet #n
*prsv n            Reserve power outlet #n for current user
*punrsv n          Unreserve power outlet #n for current user
mac                print the mac addr
ping 10.10.26.236  ping an ip address
acl 0/1            Disable/Enable ACL
*aclset id type mask id(1-6), type(0=Not Care/1=Permit/2=Block), mask(ip)
smtp lalalalala    send an email
getmail            fetch mail from pop3 server
#web 0/1           disable/enable web access
#pop3 0/1          disable/enable pop3 access
#telnet 0/1/2      config telnet access to disable/login_only/enable
dns www.sina.com.cn domain name server
*dhcp              do dhcp routin
*ip 10.10.26.123   set network static ip
*gw 10.10.26.1     set network gateway
*netmask 255.255.255.0 set network netmask
*ifconfig auto/dhcp/static do network interface config
nwshow             display network status
help               show help messages
*!                 Repeat the last command

```

>

Control Command Help Menu

Using Configuration Menu

Starting Configuration Menu

There are four ways to start the Configuration Menu:

1. Local Master Port access method. The user run a terminal program from a work station and Local Master Port of the system via serial connections between a serial port .
2. External Modem device access method. Run a terminal program from a remote work state and establish the connection via a telephone line.
3. Telnet access method. Your workstation and the system are connected to LAN.
4. Web access method. Your workstation and the system are connected to LAN.

Viewing and Changing Operation Status

XPC CORPORATION

USER: admin
SYSTEM: SPD-0215

System Operation Status
C-A:0.00A

Power Outlets					
Port #	On/Off	Reboot	Status	Port Name	Reservation
1				Outlet 1	Open
2				Outlet 2	Open

Reboot duration is 5 seconds.

System Operation Static (Web Page)

With this web page, you are able to:

- View on/off status for each power outlet. As shown in the table, Power outlet 1 is power on (illuminated in red) and outlet 2 is power off (not illuminated, in grey).
- Change power outlet on/off status by clicking “on/off” switch button icon.
- Reboot a power outlet by clicking “Reboot” push switch button icon.
- Get present current and temperature by clicking “System Status” link.

Helpful info:

- Control command “pset n v” executes the same function as the clicking “on/off” push switch button icon
- Control command “rb n” executes the same function as the clicking “Reboot” push switch button icon

Power Outlet Setup Menu

This section describes:

1. Power Outlet Configuration
2. AutoPing Functions



XPC CORPORATION

USER: admin

SYSTEM: SPD 0215

- System Status
- Power Outlet Setup
- Outlet Timer Setup
- User Account Setup
- System Control
- Serial Port Setup
- Network Setup
- Alarm Setup
- Help

Power Outlet Setup Menu

Date: 03/26/2016 Time: 05:32:45

Number	Name	On/Off	Reservation	Autoping and reboot	Ping Ip	Email notify if autoping failed
1	Outlet 1	On	Open	Off	0.0.0.0	Off
2	Outlet 2	On	Open	Off	0.0.0.0	Off
Reboot Duration In Seconds		5				

Submit Reset

Power Outlet Setup Menu (Web Page)

Name:

Define a name for the power outlet.

On/Off:

Set the power outlet to power on or off state.

Reservation:

Reserve the port for special user.

AutoPing and reboot (Power reboot If user equipment's network is down)

Disable or enable AutoPing power reboot function. If it is enabled, the system schedules auto pings to the communication equipment that is connected to the power outlet. If no response is received in a period of time (user defined, see below) from the communication equipment, the system starts the power reboot process for the power outlet.

Ping Ip(AutoPing (Ping) destination IP address) :

Enter an IP address of the probed communication equipment. This IP address is associated to the power outlet.

Email notify if autoping failed

Disable or enable sending email notify if autoping failed. Only available if AutoPing and reboot if on.

Reboot Duration In Seconds

Setting the reboot duration if the autping is failed or clicking "Reboot" push switch button icon. The unit is second.

Helpful Info:

Use command "pshow" to display all power outlet status.

```
*****
*
*
*      Power Outlet Port Parameters and Status
*
*
*
*****
>
>
```

Port	Name	status	Reserved By	Timer	AutoPing
01	encoder	ON	admin	OFF	ON
02	Undefined	OFF	Open	OFF	OFF

List of Power Outlet Status (Terminal Screen)

Power Outlet Timer Setup Menu

This is an example of the power outlet in Timer off mode. To enable the Timer, select "Timer Mode" on.



USER: admin

SYSTEM: SPD-0215

- System Status
- Power Outlet Setup
- Outlet Timer Setup
- User Account Setup
- System Control
- Serial Port Setup
- Network Setup
- Alarm Setup
- Help

Power Outlet Timer Setup Menu

Date: 03/26/2016 Time: 05:34:05

Port #	Timer Mode	Timer In Standard Mode (see Help information below)			
		Timer Starting Time (year:mon:day:hour :min:sec)(Calender Time)	Timer Period (day:hour :min:sec)	Loop Count	Toggle Duration (second)
1	Customized	View Customized Settings			
2	Off	Off	Off	Off	Off

Submit Reset

Help Information (Standard Mode)

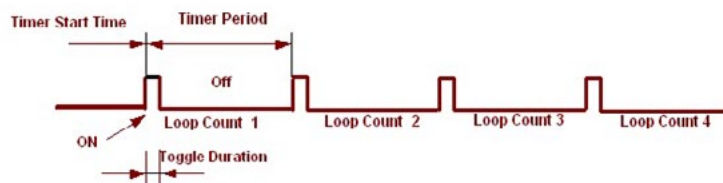

Power Outlet Timer Setup Menu (Web Page)

Timer Mode:

Select the timer mode: Off/Standard/Customized

Timer Start Time:

Specify starting time for the timer. The starting time is the actual calendar date and real-time clock. Once a timer reaches this specified Start Time, the power outlet on/off state will flip. It is in the format of "year:month:day:hour:minute:second". For example, to start changing the power outlet on/off state at 7:17:27pm, on July 20th 2008, the entry data is 08:07:20:19:17:27.

Timer Period:

Specify the timer period. It is in the format of "days:hours:minutes:seconds", which is not a calendar and real-time clock entry type. The period setting is used for applications that require the power outlet to continuously change on/off in a specific interval. For example, you need to schedule power reboot for the outlet daily, the period is 24 hours. Your entry will be 00:24:00:00.

Timer Loop Count:

The number of Periods for the Timer is defined as Loop Count. For example, you schedule the timer to flip the power outlet states in every 20 seconds and want to repeat 300 times, your entry will be 300.

Toggle Duration:

Specify the duration of the power outlet and state the toggles when a new Timer Period starts. This parameter is meaningful if the Timer Loop Count is > 0. The unit for the duration is in seconds. The concept of the specification can also be viewed as Duty Cycle. The value of this parameter should be $0 < \text{Toggle Duration} < \text{Timer Period}$.

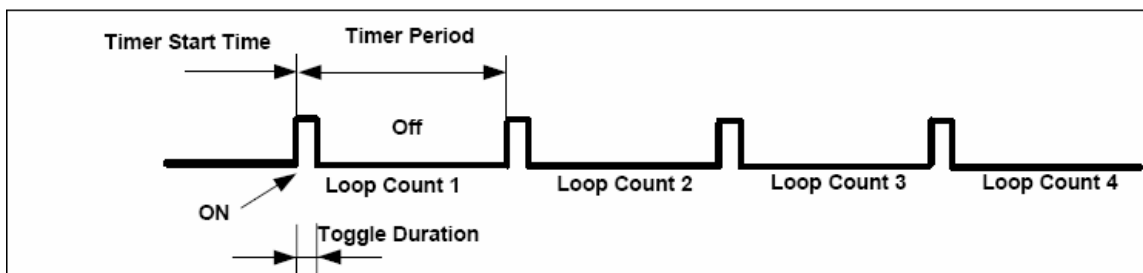
ON Off**Timer Period****Loop Count 1 Loop Count 2 Loop Count 3 Loop Count 4****Timer Start Time****Toggle Duration**

Definitions of Timer Parameters

There are a few examples of applications using the Power Outlet Timers:

1) Reboot daily:

Current Calendar date and time are: Aug. 10th, 2008, 10:00 am.

Requires daily power Reboot at 1:00am. Reboot duration is 10 seconds.

Timer Start=08:08:11:01:00:00 - Reboot starts on Aug. 11th, 2008,1:00 am.

Timer Period = 1:0:0:0 - Period is 1 day, 0 hour, 0 minute, and 0 second.

Timer Toggle Duration = 10 - Power outlet will toggle on/off state for 10 seconds.

Timer Loop Count = 1000 - 1000 days.

2) Toggle Power Outlets for 300 times:

Toggling Power outlet on/off and state 300 times in a period of 10 seconds, meantime starts it immediately. Current Calendar date and time are: Aug. 10th, 2008, 10:00 am.

Timer Start Time = 08:08:10:10:00:20 - Start toggling on Aug. 10th, 2008, at 10:00:20 am.

Timer Period = 20 - Choose 20 seconds and duty cycle 50%. Note: the period setting is not 10.

Timer Toggle Duration = 10 - This results in 10 seconds on and 10 seconds off.

Timer Loop Count = 300 - 300 periods.

3) Reboot once on a specific date and time:

Current Calendar date and time are: Aug. 10th,2008, 10:00 am. To schedule a reboot on Feb 12th, 1:00 am.

Timer Start Time = 09:02:12:1:00:00 - Start the event at 1:00am,2009, on Feb. 12th, Timer Period = 6 - 6 seconds

Timer Toggle Duration = 5 - 5 seconds. Reboot duration is 5 seconds. Timer Loop Count = 1 - Reboot once.

User Account Setup Menu

User account management includes reserving or un-reserving each serial console ports and power outlets to a current login user, as well as adding new user accounts, modifying and deleting user accounts.



XPC CORPORATION

USER: admin

SYSTEM: SPD-0215

- System Status
- Power Outlet Setup
- Outlet Timer Setup
- User Account Setup
- System Control
- Serial Port Setup
- Network Setup
- Alarm Setup
- Help

User Account Setup Menu

ID	Enable	Name	Password	Permission
0	<input checked="" type="checkbox"/>	admin	*****	Admin
1	<input checked="" type="checkbox"/>	user	****	User
2	<input type="checkbox"/>			Admin
3	<input type="checkbox"/>			Admin
4	<input type="checkbox"/>			Admin
5	<input type="checkbox"/>			Admin
6	<input type="checkbox"/>			Admin
7	<input type="checkbox"/>			Admin

Submit Reset

User Account Management Menu (Web Page)

Helpful Info:

Use the command "ul" to view all existing account

System Access Setup Menu**System Access Control Menu**

Item	Value
System(or Site) Name	<input type="text" value="PDU"/>
Time(hh:mm:ss)	<input type="text" value="05:35:59"/>
Date(mm/dd/yyyy)	<input type="text" value="03/26/2016"/>
Master Serial Port Mode	PC Console <input type="button" value="v"/>
Modem Startup String	<input type="text" value="AT&D0&S0&R1&C0EQ1S0=1"/>
Non-Admin Level User System Access Restriction(note)	<input type="button" value="N"/> <input type="button" value="v"/>
Enable Web Access	<input type="button" value="Y"/> <input type="button" value="v"/>
Enable Telnet	<input type="button" value="N"/> <input type="button" value="v"/>
Telnet Timeout(max 65535 minutes)	<input type="text" value="0"/>
Enable Telnet Anonymous User	<input type="button" value="N"/> <input type="button" value="v"/>
Enable Command Control Via Email	<input type="button" value="N"/> <input type="button" value="v"/>
Enable SNMP agent	<input type="button" value="N"/> <input type="button" value="v"/>
SNMP Community String(Pub, Private, Trap)	<input type="text" value="public"/>
Enable SNMP Trap	<input type="button" value="N"/> <input type="button" value="v"/>
SNMP Trap Receiver IP Address(x.x.x.x)	<input type="text" value="192.168.1.2"/>

System Access Control Menu (Web Page)**System(or Site) name:**

Assign a system name, sometimes referred as site or device name.

Date and Time:

Enter calendar date and real-time clock.

Serial Port Mode:

Configure the Local Master Port to interface type: either to a serial RS-232 port on your work station or an external Modem device. An external Modem device is typically equipped with a DCE (Data Communication Equipment) terminal connector. Since the system's Local Master Port and Modem device ports are not complementary, you need to use a NULL Modem cable with both male connectors. For information about connector pin assignment, please see appendix A.

Modem Startup String:

Define an external Modem control command string that is sent from the system to an external modem device periodically (in every 15 minutes). If you do not need to define the control string, leave the entry field empty.

Web Access:

Enable or disable web access to the system. Default to enable.

Telnet Access:

Enable or disable Telnet access to the system. Default to enable. Only one active Telnet session is permissible.

Enable Telnet Anonymous User:

Enable or disable an anonymous user's access to Telnet port.

Control command via Emails:

Enable or disable this access method. When it is enabled, you need to make sure you also have completed POP/SMTP server and email receiving and sending addresses. See "TCP/IP Network Configuration" setup menu for detailed information how to setup email accounts. Default to disable.

SNMP Agent Enabling:

Enable or disable SNMP agent on the system. If the system SNMP Agent is enabled, it collects and stores management information and makes this information available to NMS (Network Management System) using SNMP. Please see Section 2.5 for a available MIB objects that the system supports. Default to disable.

SNMP Trap Enabling:

Enable or disable Trap sending. If this option is enabled, Traps are sent if there is a power reboot command execution on the system. Default to disable.

Note: you must enable the above SNMP Agent setting. Otherwise, enabling Trap setting will not take effect.

SNMP Trap Receiver IP Address:

Enter Trap Monitoring receiver IP address.

SNMP Community String:

To specify SNMP MIB/Trap community string. The default string is "public". This string is used for public, private and Trap.

Current A and B Alarm Threshold:

To defined AC current draw alarm threshold. The unit is Amps.

Temperature Alarm Threshold:

To defined temperature draw alarm threshold. The unit is Centigrade.

Serial Port Setup Menu

This section describes serial console port configuration and operating settings. Serial Console Port configuration starts with the following menu:

Serial Port Setup Menu

Port	Port Name	Baud Rate	Data Bit	Parity	Stop Bit	Flow Control
M	Master	115200 ▾	8 ▾	NONE ▾	1 ▾	NONE ▾

Submit Reset

Serial Port Setup Menu (Web Page)

Baud Rate:

The system supports the following baud rates: 2400, 4800, 9600, 19200, 38400, 57600 and 115200. It is strongly recommended that Master port and a user serial port have the same data rate while exchanging data between them so that data loss is eliminated. If you must run both ports using different baud rates, Flow Control (hardware handshaking) should be enabled on all connected serial console ports.

Please also note that when Telnet access is used for exchanging data between the system's Ethernet interface port and user communication equipment, without enabling flow control, you might experience data loss when data exchange rate is high. This is because data flow from the system's Ethernet port is subject to the congestion condition of LAN traffic.

Data Bit:

Supports 7 or 8 bits.

Stop Bits:

Supports 1 or 2 bits.

Parity Bits:

Supports Even, Odd or None.

Flow Control:

Flow Control is hardware handshaking using CTS/RTS signals on the connectors. Please see Appendix A for information about RS232 connector pin assignments.

Port Name:

Assign a name for the port. Always assigned to the name "Master".

TCP/IP Network Configuration Menu

Network Setup Menu

Item	Value
Obtain IP using DHCP	N <input type="button" value="v"/>
Fallback to static IP(if DHCP failed)	Y <input type="button" value="v"/>
Static IP (x.x.x.x)	<input type="text" value="192.168.1.100"/>
Subnet Mask(x.x.x.x)	<input type="text" value="255.255.255.0"/>
Gateway IP (x.x.x.x)	<input type="text" value="192.168.1.1"/>
Set DNS Server IP Manually	Y <input type="button" value="v"/>
Primary DNS IP (x.x.x.x)	<input type="text" value="211.161.46.84"/>
Secondary DNS IP (x.x.x.x)	<input type="text" value="211.161.46.85"/>
HTTP Port # (Default-80, requires power reboot if changed)	<input type="text" value="80"/>
Telnet Port # (Default-23)	<input type="text" value="23"/>
POP3 Port # (Default-110)	<input type="text" value="110"/>
SMTP Port # (Default-25)	<input type="text" value="25"/>
NTP Port # (Default-123)	<input type="text" value="123"/>
Incoming Email-POP3 Server	<input type="text" value="pop.sina.com"/>
Outgoing Email-SMTP Server	<input type="text" value="smtp.sina.com"/>
Account Name(e.g.: rcsuser@sina.com)	<input type="text" value="rcsuser@sina.com"/>
Account Password	<input type="password" value="....."/>
Reply or AutoPing Report Email Address (e.g.: mymail@hotmail.com)	<input type="text"/>
Outgoing Email Authentication SMTP	N <input type="button" value="v"/>
Checking Email Interval (Seconds)	<input type="text" value="1800"/>
Access Control List(ACL) Enable	N <input type="button" value="v"/>
IP Access Control Mask 1	Do Not Care <input type="button" value="v"/> <input type="text" value="0.0.0.0"/>
IP Access Control Mask 2	Do Not Care <input type="button" value="v"/> <input type="text" value="0.0.0.0"/>
IP Access Control Mask 3	Do Not Care <input type="button" value="v"/> <input type="text" value="0.0.0.0"/>
IP Access Control Mask 4	Do Not Care <input type="button" value="v"/> <input type="text" value="0.0.0.0"/>
IP Access Control Mask 5	Do Not Care <input type="button" value="v"/> <input type="text" value="0.0.0.0"/>
IP Access Control Mask 6	Do Not Care <input type="button" value="v"/> <input type="text" value="0.0.0.0"/>
Network Connection Check Using This IP (leave blank if Gateway IP is used. Applicable to AutoPing Mode)	<input type="text" value="0.0.0.0"/>
Get SNMP MIB File	

TCP/IP Network Configuration Menu (Web Page)

Obtain IP using DHCP:

Enable or disable DHCP. The purpose of using DHCP (Dynamic Host Configuration Protocol) is to assign dynamic IP addresses to a computer or a network device on a network. There must be a DHCP server on a network running and the server must permit an assigned computer or network device to be on the LAN. If this option is disabled, the system will not send DHCP requests to a network.

Fallback to static IP (if DHCP failed):

Define a static IP address. If DHCP is disabled on the system, there is no DHCP server running on a network, or a DHCP server refuses IP offering, you have the option to whether either allow the system to use a static IP address or not.

Static IP Address:

A static IP Address is never changed. This IP address will be used if a DHCP server IP has no IP offered or DHCP automatic IP address is disabled.

Subnet Mask:

Defines a static subnet mask that is a part of your static network address settings. This entry is for your IP network class, which is distinguished by using a subnet mask.

Gateway IP address:

Specifies a gateway IP address that is a part of your static network address settings. This is your router's IP address.

Set DNS Server IP manually:

Specifies a DNS Server IP manually.

Primary DNS IP:

Specifies a primary DNS IP address.

Secondary DNS IP:

Specifies a secondary DNS IP address.

HTTP Port Number:

Specifies a HTTP port number. Default value is 80.

Telnet Port Number:

Specifies a Telnet port number. Default value is 23.

POP3 Port Number:

Specifies a POP3 port number. Default value is 110.

SMTP Port Number:

Specifies a SMTP port number. Default value is 25.

Incoming Email POP3 Server:

Specifies POP (incoming Email) server address. The system supports POP3 Internet Email Protocols, not web based Email services. "61.129.42.78" and "pop.sina.com" are examples of POP Email servers. Make sure that the POP server you use does not require log on secure password authentication.

Helpful Info: Use the command "getmail" to immediately check incoming emails.

Outgoing Email SMTP Server:

Specifies SMTP (outgoing Email) server address. This server will be used for you to send outgoing (reply) Emails. "61.129.42.78" and "smtp.sina.com" are examples of SMTP Email servers. NP supports SMTP log on secure password authentication option.

Helpful Info: use the command "smtp lalala" to immediately send emails.

Account Name:

Specifies email address that the system receives. This email account name is also used for outgoing (replying) emails.

Account Password:

The Email account password is specified in this entry. This password is also used for outgoing (replying) emails.

Reply or AutoPing Report Email Address:

This is an additional email address which used in smtp testing, Autoping report and alarm report. Also, the system always send replying email to the sender. There is no limitation of types of destination email servers, whether a web based emailing system or SMTP. Examples of destination addresses are myMail@163.com

Helpful Info: use the command "smtp lalala" to immediately send emails to this email address.

Outgoing Email Authentication SMTP:

If an SMTP (outgoing) email requires a user name and password authentication, enter "Y" for this entry.

Check Email Interval (Seconds):

This entry specifies how often the system checks incoming emails. The interval unit is second.

Access Control List (ACL) Enable:

Enable or disable for controlling client IP addresses to access the system.

Network Connection Check Using This IP:

This entry specifies an IP address or a URL site that the NP system will ping periodically for verification of network connectivity. If the network connection is down or inactive, AutoPing is in off mode. If this entry leaves blank, network gateway IP address will be used.

Get SNMP MIB File:

It is a MIB (Management Information Base) text file which collects and stores management information and makes this information available to NMS(Network Management System) using SNMP.

More About TCP/IP Network Configuration

There are two methods to config network. One is DHCP, the other is using static IP address. For these two methods, we provide following three options to config network:

Obtain IP using DHCP

Get IP by DHCP.

Helpful Info: use the command "ifconfig dhcp" to perform this function

Fallback to static IP(if DHCP failed)

Define a static IP address. If DHCP failed, allow the system to use a static IP address.

Helpful Info: use the command "ifconfig auto" to perform this function

Using static Ip address

Do not use DHCP, directly use a static IP address for the system.

Helpful Info: use the command "ifconfig static" to perform this function.

Caution:

- If using a static IP address, after config ip, netmask and gateway, you must run command "ifconfig static" to enable static IP address.
- If using DNS function(e.g. set pop3 server), you must set DNS server IP address manually.

More about Emailing Access

Sending Control command to the system:

A control command is placed in the email content field and only support pure text format. It has the following format:

username

password

Command

where "*username*" and "*password*" are valid user account name and password; and "*command*" is the actual system control command. The subject field has the following format:

rcs

For example, sending email subject "rcs" and content"

admin

admin

help

"will get all email supporting command. The user name is "admin" and password is "admin".

After a command is executed, a confirmation reply email is sent. The destination of the replying email address is already defined in the Network Configuration Table.

A control command is not executed if the subject field doesn't match, or user name does not exist, or the name does not have the privilege to operate the designated serial console port or power outlet port, or if there is a command syntax error. If this happens, a reply email is sent to indicate the problem of the command.

Helpful Info: Use command "getmail" to check incoming emails immediately. Use command "smtp lalala" to send a test mail immediately.

Appendix A: Serial Console Port Interfaces

RS-232 – RJ45 (8-pin)

C-RJ45-DB9F-4, RJ-45 to RS232 (Female, DCE) cable, 4'.

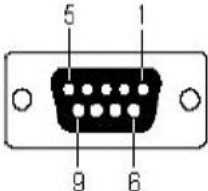
RS-232 – DB9 Female			RJ45 (8-pin)		
Pin No.	Signal	DB-9 F	8	Pin No.	Signal
1	DCD		8	1	DSR
2	TxD			2	RTS
3	RxD			3	GND
4	DSR			4	TxD
5	GND			5	RxD
6	DTR			6	DCD
7	CTS			7	CTS
8	RTS			8	DTR
9	---				

RS-232 – RJ45 (8-pin)

C-RJ45-DB9M-4, RJ-45 to RS232 (Male, DTE) cable, 4'.

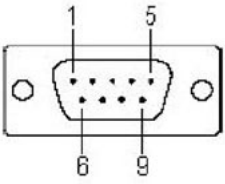
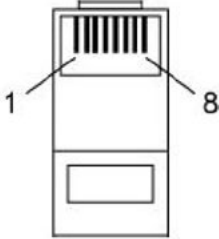
RS-232 – DB9 Male			RJ45 (8-pin)			
Pin No.	Signal	DB-9 M	8	Pin No.	Signal	
1	DCD		8	1	DSR	
2	RxD				2	RTS
3	TxD				3	GND
4	DTR				4	TxD
5	GND				5	RxD
6	DSR				6	DCD
7	RTS				7	CTS
8	CTS				8	DTR
9	---					