



# P90 Online UPS

1000VA, 1500VA, 2000VA, 3000VA Models

User & Installation Manual

## Table of Contents

<b>Introduction.....</b>	<b>6</b>
<b>Product Description.....</b>	<b>6</b>
Double Conversion Online Technology.....	6
Diagnostic Tests.....	7
<b>System Configuration.....</b>	<b>7</b>
Communication Connections.....	9
Emergency Power Off (EPO) Port.....	10
<b>Hardware Installation Guide.....</b>	<b>11</b>
UPS Installation.....	12
Starting the UPS.....	17
Software Installation.....	17
Battery Replacement.....	17
<b>Operations.....</b>	<b>20</b>
Button Operation.....	20
LCD Panel.....	20
Audible Alarms.....	22
Abbreviations in LCD Display.....	22
UPS Setting.....	23
Operating Mode Description.....	27
Fault Reference Codes.....	28
Warning Indicators.....	29
<b>Troubleshooting.....</b>	<b>30</b>
<b>Storage And Maintenance.....</b>	<b>32</b>
Storage.....	32
Maintenance.....	32
<b>Batteries.....</b>	<b>32</b>
<b>Specifications.....</b>	<b>33</b>
<b>Shipping List.....</b>	<b>33</b>

**Obtaining Service.....34**

**Xtreme Power Conversion Limited Warranty.....35**

**Xtreme Power Conversion Load Protection Policy.....36**

**Appendix A: P90-BP36, P90-BP48 & P90-BP72 User Guide.....39**

    Important Safety Instructions.....39

    Product Overview and Setup.....39

    Type of Battery Required.....41

    Battery Replacement.....41

    Wiring Diagram.....48

    Storage & Maintenance.....51

Thank you for selecting this uninterruptible power supply (UPS). It provides you with protection for connected equipment. Please read this manual before installing the P90-Series UPS models P90-1000, P90-1500, P90-2000 and P90-3000 as it provides important information that should be followed during installation and maintenance of the UPS and batteries, allowing you to correctly set up your system for the maximum safety and performance. Included is information on customer support and service, if it is required. If you experience a problem with the UPS, please refer to the Troubleshooting section in this manual to correct the problem. If the problem is not corrected, please collect information so that the Technical Support personnel can more effectively assist you.

## **IMPORTANT SAFETY INSTRUCTIONS: (SAVE THESE INSTRUCTIONS)**

**CAUTION! (UPS having Internal Batteries):** Risk of electrical shock – Hazardous live parts inside this unit are energized from the battery supply even when the input AC power is disconnected.

**CAUTION! (No User serviceable Parts):** Risk of electrical shock, do not remove cover. No user serviceable parts inside. Refer servicing to qualified service personnel.

**CAUTION! (Non-isolated Battery supply):** Risk of electric shock, battery circuit is not isolated from AC input, hazardous voltage may exist between battery terminals and ground. Test before touching.

**WARNING! (Fuses):** To reduce the risk of fire, replace only with the same type and size of fuse.

**WARNING!** Unit intended for installation in a controlled environment.

**CAUTION!** Do not dispose of batteries in a fire, the battery may explode.

**CAUTION!** Do not open or mutilate the battery, released electrolyte is harmful to the skin and eyes.

**CAUTION!** A battery can present a risk of electric shock and high short circuit current. The following precaution should be observed when working on batteries:

- Remove watches, rings or other metal objects.
- Use tools with insulated handles.

To reduce the risk of electric shock, disconnect the UPS from the main supply before installing a computer interface signal cable. Reconnect the power cord only after signaling interconnections have been made.

Servicing of batteries should be performed or supervised by personnel with knowledge of batteries and the required precautions. Keep unauthorized personnel away from batteries.

These UPS units are extremely heavy. Caution should be taken in moving and positioning equipment. The instructions contained within this safety manual are deemed important and should be closely followed at all times during installation and follow-up maintenance of the UPS and batteries.

**CAUTION**

The unit has a dangerous amount of voltage. If the UPS indicator is on, the unit's outlets may have a dangerous amount of voltage even when not plugged into the wall outlet because the battery may continue to supply power.

Care should be taken to undertake installation indoors, free from electrically-conductive particles which are under temperature and humidity control, in order to reduce the risk of electric shock.

It is best to disconnect the device using the power supply cord. Ensure that the equipment is placed in a position near the outlet where easily accessible.

Except for replacing the batteries, all servicing on this equipment must be carried out by qualified service personnel.

Before conducting any maintenance, repair, or shipment, first ensure that everything is turned off completely and disconnected.

For additional safety instructions, please use the Safety Manual as a reference.

**Special Symbols**

The following symbols used on the UPS warn you of precautions:



RISK OF ELECTRIC SHOCK - Please observe the warning that a risk of electric shock is present



CAUTION: REFER TO OPERATOR'S MANUAL - Refer to the operator's manual for additional information, such as important operating and maintenance instructions.



SAFE GROUNDING TERMINAL - Indicates primary safe ground



LOAD ON/OFF – Pressing the button turns on/off the output receptacles and the indicator light.



RJ45 RECEPTACLE – The receptacle provides network interface connections and telephone or telecommunications equipment should not be plugged into it.



Please do not discard the UPS or the UPS batteries as the UPS may have valve-regulated lead-acid batteries. Please recycle batteries appropriately.

## Introduction

The information provided in this manual covers single phase 1000VA, 1500VA, 2000VA, and 3000VA uninterruptible power systems, their basic functions, operating procedures, options available and emergency situations. It also includes information on how to ship, store, handle, and install the equipment. Only detailed requirements of the UPS units are described herein, and installation must be carried out in accordance with this manual. Electrical installation must also carefully follow local legislation and regulations. Only qualified personnel should conduct these installations as failure to acknowledge electrical hazards could prove to be fatal.

## Product Description

Many different kinds of sensitive electrical equipment can be protected by an Uninterruptible Power Supply (UPS) including computers, workstations, process control systems, telecommunications systems, sales terminals, other critical instrumentation, etc. The purpose of the UPS is to protect these systems from poor quality utility power, complete loss of power, or other associated problems.

Electrical interference exists in many forms, causing problems in AC power, from lightning, power company accidents and radio transmission motors, air conditioners, and vending machines. Protection of sensitive electrical equipment is vital to protect against power outages, low or high voltage conditions, slow voltage fluctuations, frequency variations, differential and common-mode noise, transients, etc.

To prevent power line problems from reaching critical systems causing damage to software, hardware, and equipment malfunctions, the UPS maintains constant voltage, isolating critical load output and cleaning the utility AC power.

### *Double Conversion Online Technology*

A double conversion on-line technology UPS provides completely isolated, clean, uninterrupted single-phase power to your critical systems, while maintaining the batteries for their maximum potential. In the event that the power failure lasts longer than the UPS backup time, the UPS will shut down avoiding battery damage. When the input AC voltage returns, the UPS will automatically return online to recharge the batteries.

As shown in block diagram:

- An input filter reduces transients on the incoming utility.
- To maintain full battery charge, the AC input power is rectified and regulated in the rectifier feeding power to the battery converter and inverter.
- DC power is converted to AC in the inverter, passing it on to the load.
- Power is maintained from the battery during a power failure.
- The converter increases voltage appropriately for the inverter.

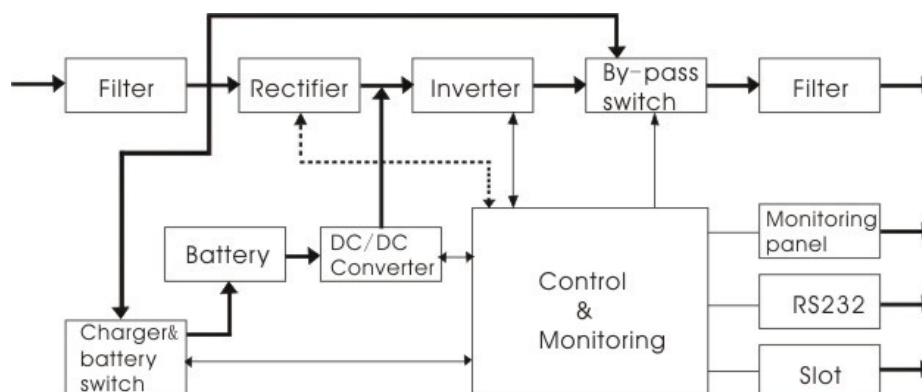

## Diagnostic Tests

When the UPS is started, a diagnostic test is automatically executed, checking the electronics and batteries, reporting any problems on the LCD display.

## System Configuration

The UPS device and the internal batteries make up the system. Depending on the site and load requirements of the installation, certain additional options are available for the solution.

Planning a UPS system, the following should be taken into consideration:

- The total demand of the protected system shall dictate the output power rating (VA). Allow a margin for future expansion or calculation inaccuracies from measured power requirements.
- Backup time required will indicate the battery size needed. If the load is less than the UPS nominal power rating, then actual backup time is longer.
- The following options are available:
  - o Connectivity Options – Web/SNMP Card, Relay Card, Modbus Card
  - o Battery packs, rail kits, bypass switches

See the Specification section of this manual for additional model information.



P90 front view

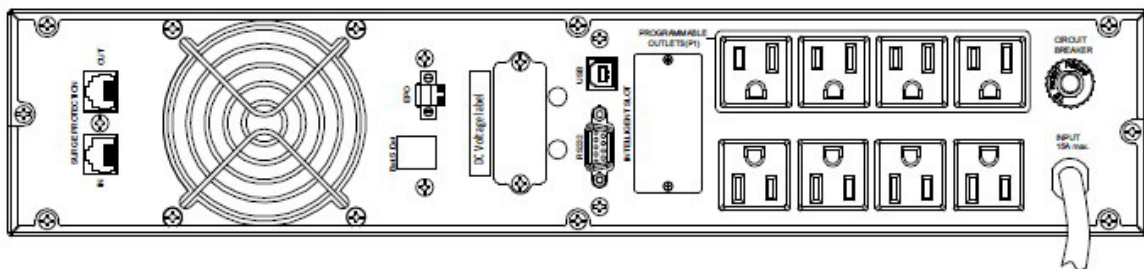

P90-1000 rear view

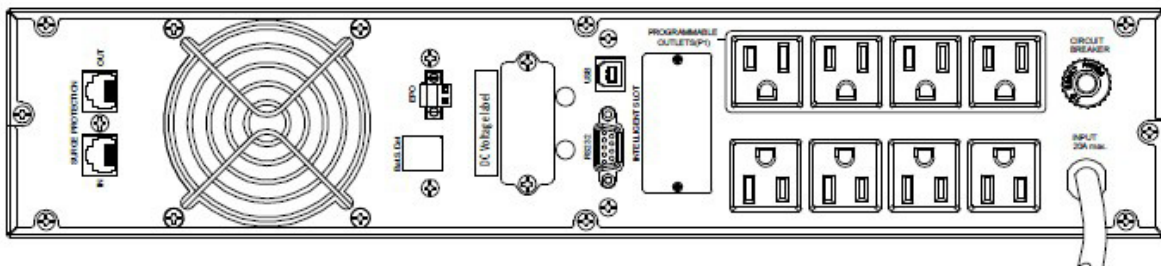

P90-1500 rear view

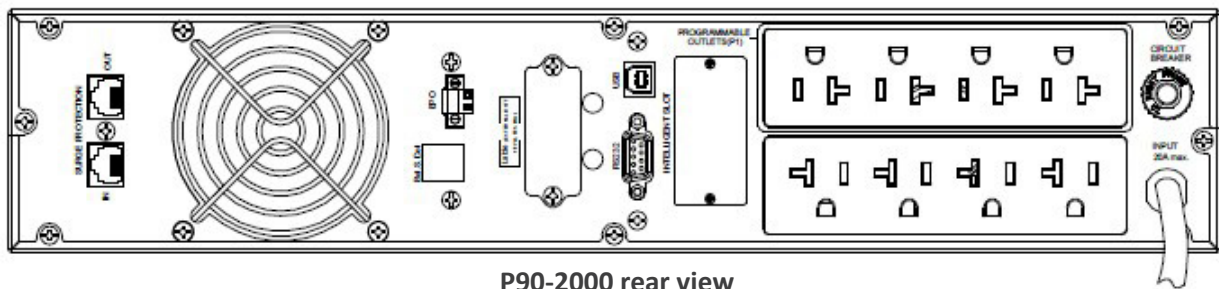

P90-2000 rear view

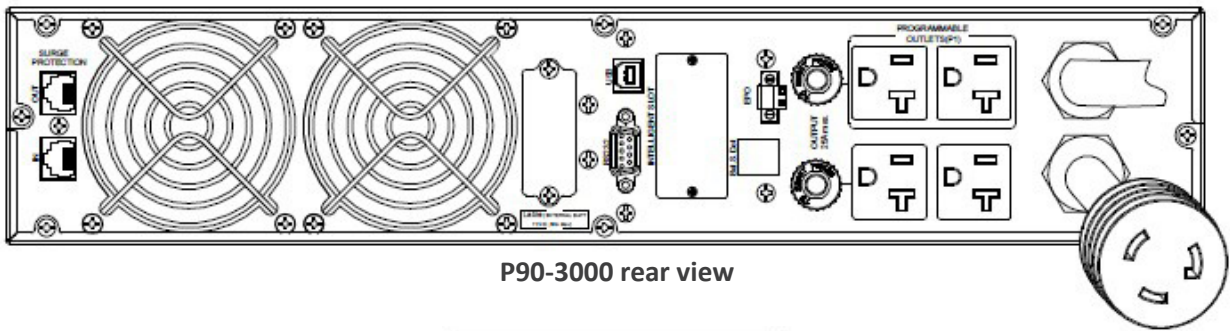

P90-3000 rear view

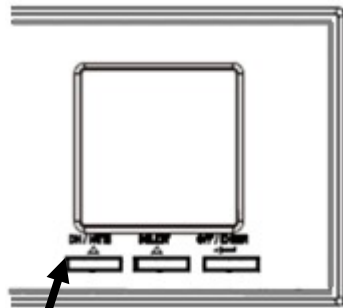

Front panel

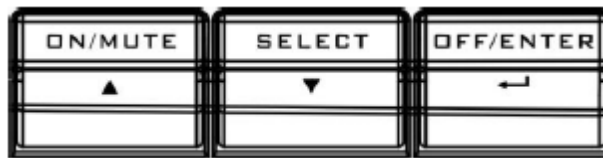

Selector buttons

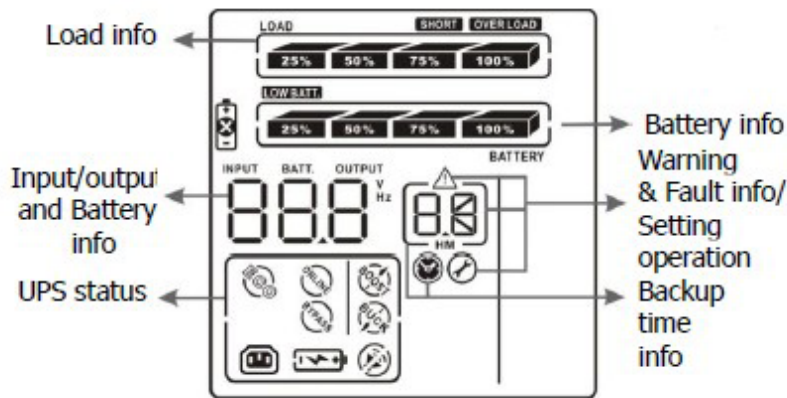

Rack display



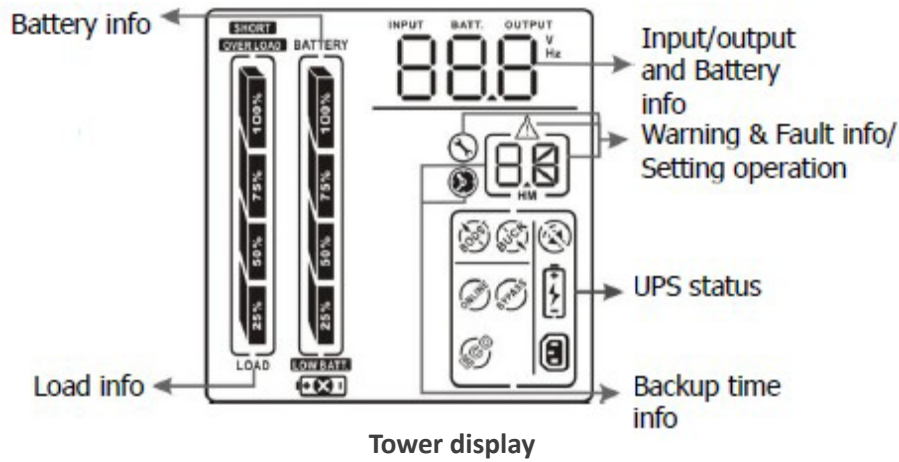

**Communication Connections**

To allow for unattended UPS shutdown/start-up and status monitoring, connect one end of the communication cable to the USB/RS232 port and the other to the communications port on your PC or server. With the monitoring software installed, the UPS can be scheduled for shutdown/start-up and monitoring of the UPS status through the PC or server.

**USB port**



**RS-232 port**

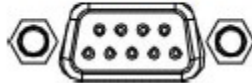

**Intelligent slot**



**RS232 Communications**

The RS-232 interface uses a 9-pin female D-sub connector. Information provided includes data about utility, load and the UPS. The interface port pins and their functions are identified in the following table:



PIN #	FUNCTIONS
1,4,6,7,8,9	Reserved
2	UPS transmit
3	UPS receive
5	Ground

**SNMP Communications Option**

The UPS provides an intelligent slot for internal or external network card. This special intelligent network card can be compatible with popular software and hardware found on the web and in operating systems. It can support operating systems such as HP Open View, IBM Netview, SUN Netmanager, etc. This enables the UPS to provide instant UPS and power information over the network. Please contact your reseller for additional details.

## ***Emergency Power Off (EPO) Port***

A customer supplied switch located remotely can be used to close the EPO connection and allows the UPS output receptacles to be switched off. Since the EPO shuts down the equipment immediately, orderly shutdown procedures are not followed by any power management software. The UPS will have to be manually restarted in order to regain power to the outlets on the UPS.

Keep Pin 1 and Pin 2 closed for UPS normal operation. To activate EPO function, open the wire between Pin 1 and Pin 2.

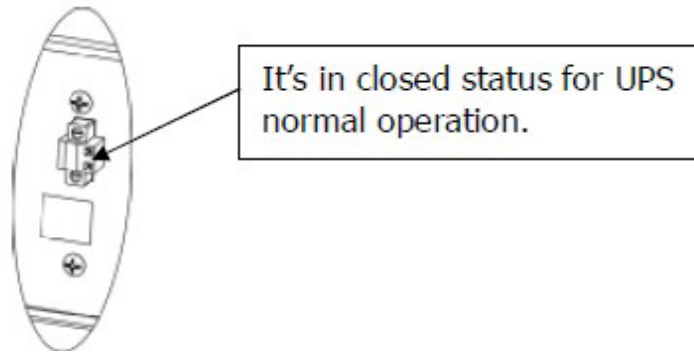

## Hardware Installation Guide

Inspect the UPS upon receipt. The packaging is recyclable; keep it for reuse or dispose of properly.

### Safety Information

Information presented here is vital to all personnel. Please read all Safety information.

### Storage and Transportation

Please handle the UPS and associated equipment with extreme caution since a high amount of energy is contained in the batteries. Always keep the unit in an upright position as marked on the packaging, and never drop the unit.

Please adhere to the following instructions if the UPS is not installed immediately:

- Store the equipment as is in its original packing and shipping carton.
- Do not store in temperatures outside the range of -15°C to +25°C
- Ensure that the equipment is fully protected from wet or damp areas and from moist air.

In order to maintain the batteries, the UPS should be recharged every 6 months for at least 8 hours.

If flammable substances such as gases or fumes are present, or if the room is airtight, a hazardous situation may exist in which no electrical equipment should be operated.

The instructions in this manual explain how to install the UPS safely. Not acknowledging such electrical hazards may be fatal – keep this manual for future reference.



### WARNING!

**It is strongly recommended that the UPS cabinet not be opened as components have very high voltage and touching those components may be fatal. Only a qualified technician or authorized agent may service the unit.**

**The UPS unit's output receptacles carry live voltage even when not connected to an input voltage source. The UPS has its own internal energy source.**

### Environment

Ensure that all environmental concerns and requirements are met according to specifications listed in this document, otherwise the safety of installation personnel cannot be guaranteed, and the unit may malfunction.

Ensure that you remember the following when locating the UPS system and battery options:

- Avoid extremes of temperature and humidity. Maximum battery life can be attained with a recommended temperature range of +15°C to +25°C.
- Provide protection for the equipment from moisture.
- Space and ventilation requirements must be met. Ensure there is 100mm behind and 50mm on the sides of the UPS for proper ventilation.
- Ensure that the front of the UPS remains clear for user operation.

## UPS Installation

Installation and wiring must be performed in accordance with the local electrical laws and regulations, and performed by appropriate personnel.

For safety considerations, the UPS is shipped from the factory with battery wires disconnected. Before installing the UPS, please follow these steps to connect the battery wires.

### Connecting the batteries

Step 1

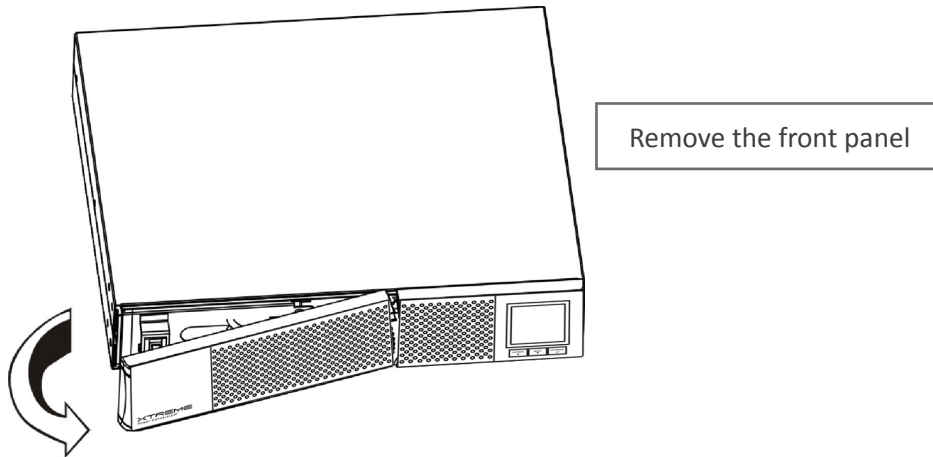

Step 2

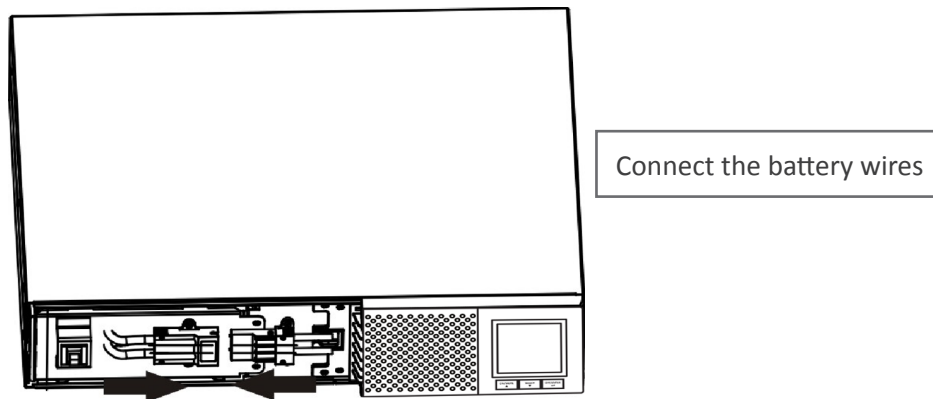

Step 3

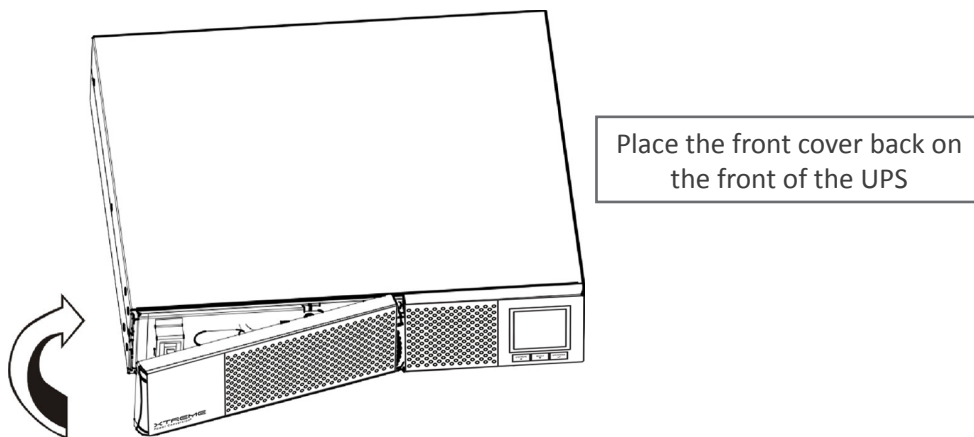

### Rack-mount Installation (using front brackets)

Step 1

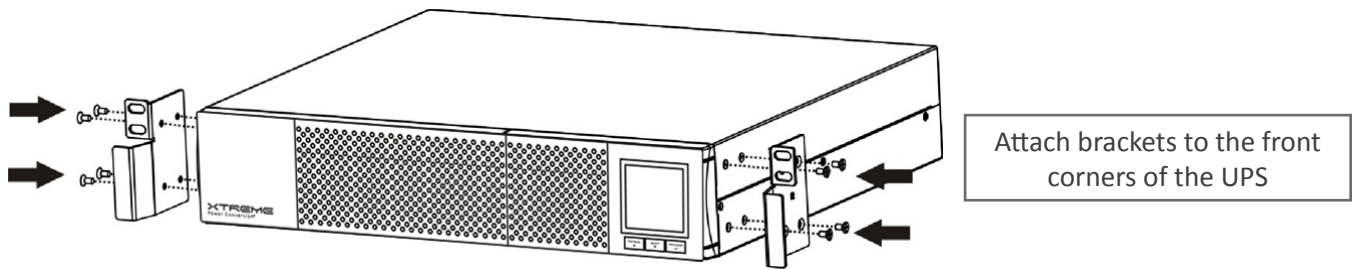

Step 2

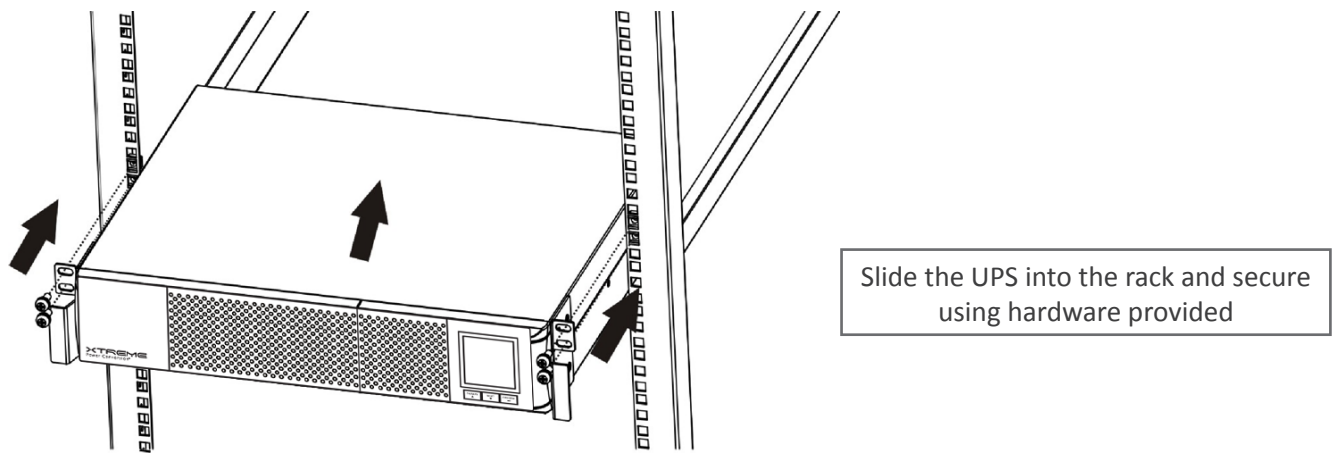

### Rack-mount Installation (using 4-post rail kit) Package contents

- Right and left rail sliders, 1 each
- (2) M6 nuts
- (12) M6 screws

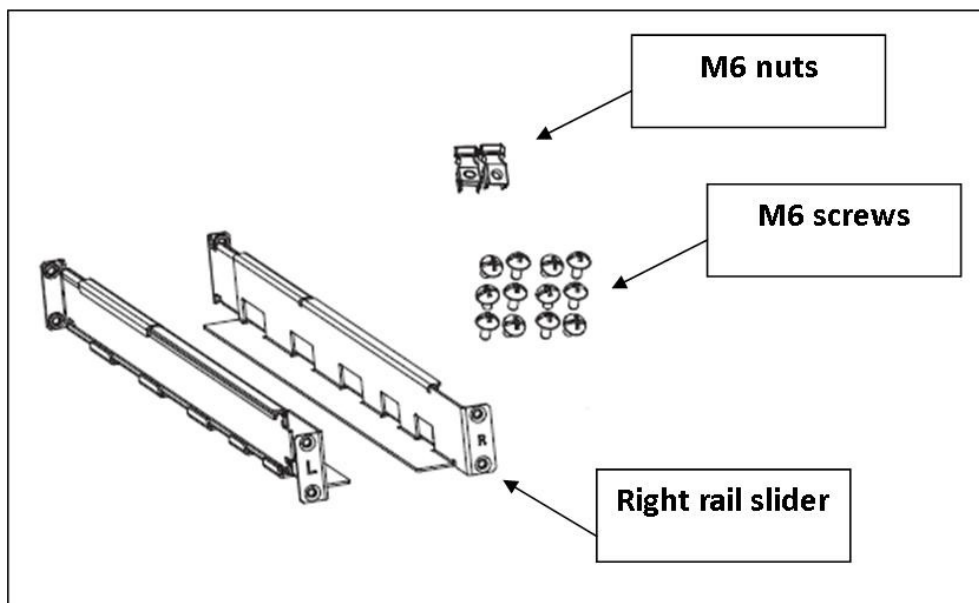

Step 1

Use 4 screws to mount right and left rail sliders in front of rack.

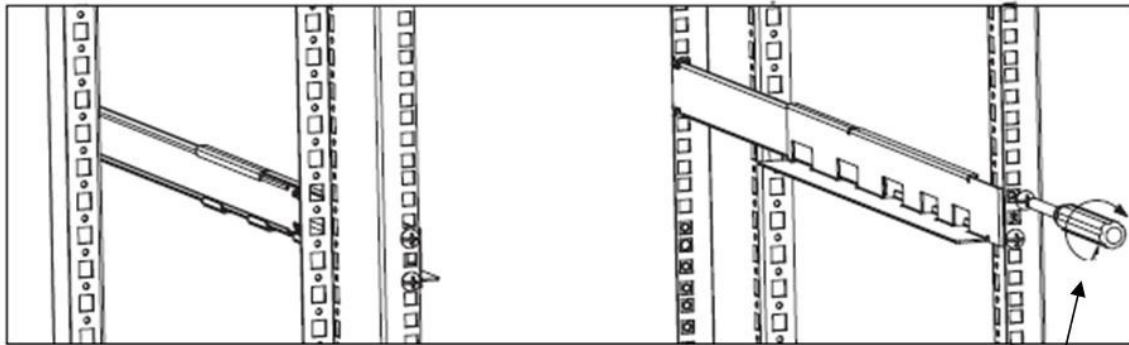

Screw driver

Step 2

Use 4 screws to mount right and left rail sliders in back of rack.

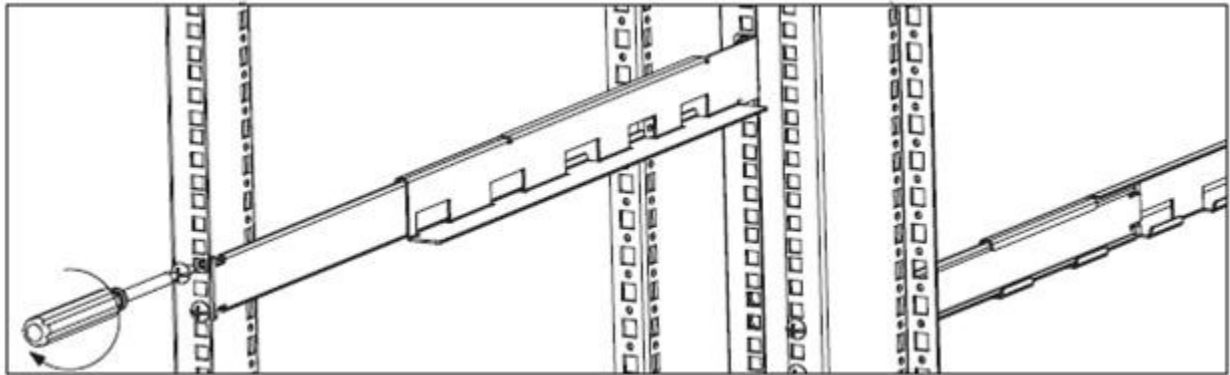

Step 3

Place the nuts in the proper location in the rack based upon height of UPS.

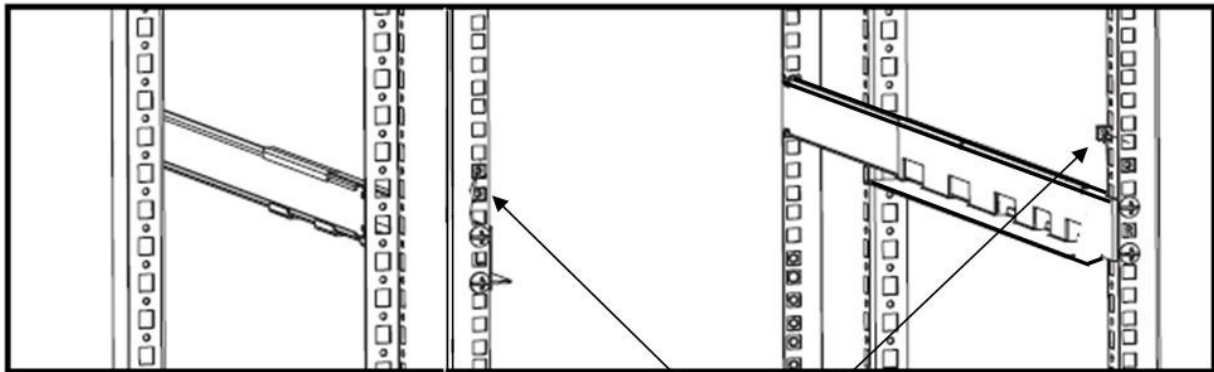

nuts

Step 4

Carefully place the UPS on the rail support.

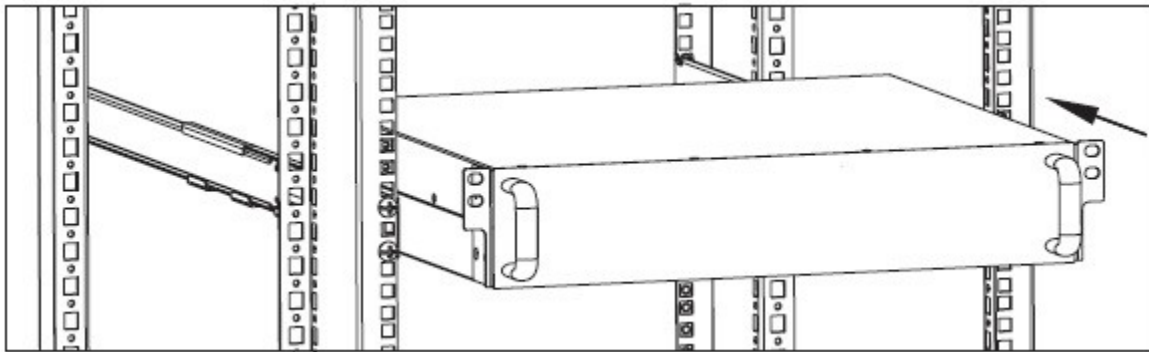

Step 5

Fix the UPS in position with screws.

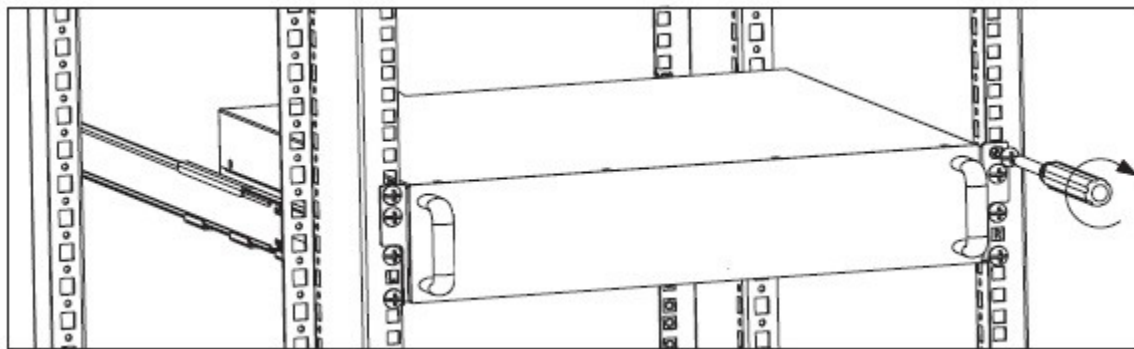

Step 6

Rail kit installation is now complete.

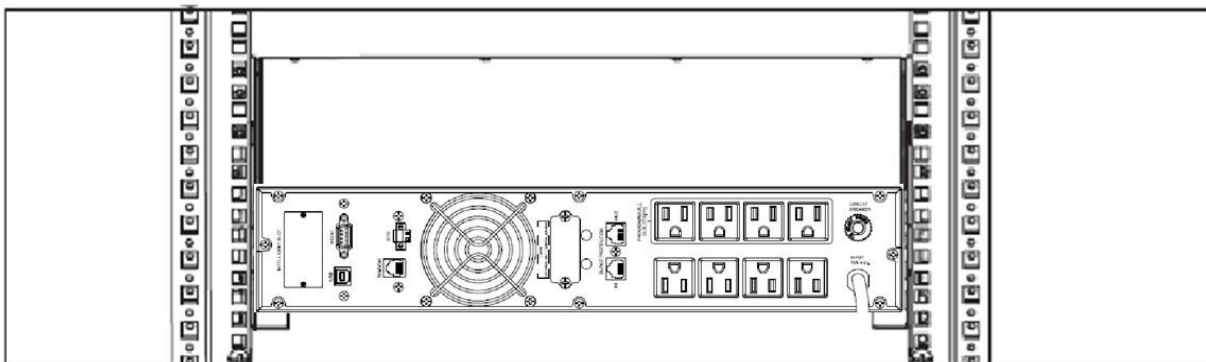



### Tower Installation

#### Step 1

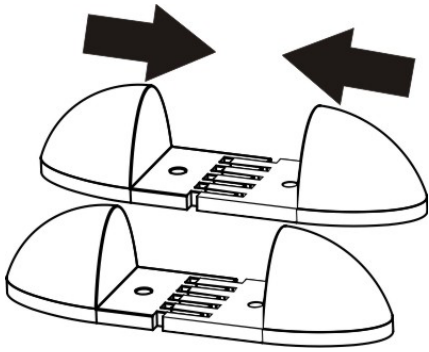

Inter-connect the tower brackets that shipped in the box with the UPS

#### Step 2

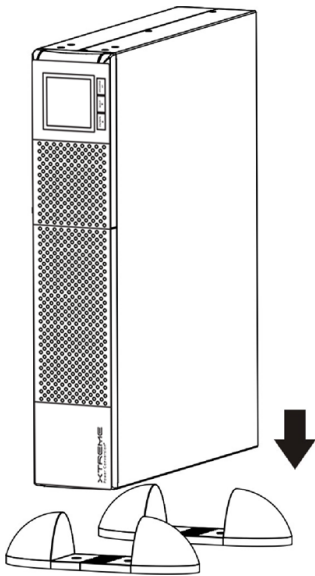

Carefully lower the UPS into the brackets as shown

#### Step 3

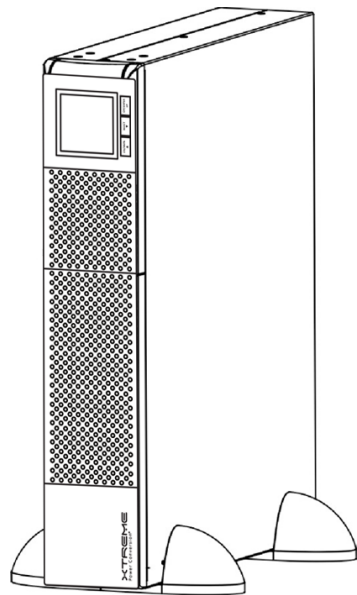

Your UPS is now mounted as shown in the tower position



### UPS Input Connection

Connect the UPS to an approved electrical input source consistent with the input power cord connection provided with the UPS. Do not replace the power cord or use a substitute. Avoid using extension cords when connecting AC input to any UPS.

### UPS Output

There are two types of output on the P90-1000, P90-1500, P90-2000, and P90-3000 models - programmable outlets and general outlets. Please connect non-critical devices to the programmable outlets and critical devices to the general outlets. During power failure, you may extend the backup time to critical devices by setting shorter backup time for non-critical devices.

Programmable outlets can also be used to re-cycle the power to remote devices if required to re-start a server due to lock-up issues.

### Starting the UPS

Press the ON/MUTE button on the front panel of the UPS for two seconds to power on the UPS.

Note: the battery charges during the first five hours of normal operation. Do not expect full battery run time during the initial charge period.



### Software Installation

For optimal system protection, install UPS monitoring software to fully configure UPS shutdown. Please follow steps below to download and install monitoring software, or simply install via the included CD:

1. Got to the website <http://www.power-software-download.com>
2. Click ViewPower software icon and then choose your required Operating System to download the software.
3. Follow the on-screen instructions to install the software.
4. When your computer restarts, the monitoring software will appear as an orange plug icon located in the system tray near the clock.

### Battery Replacement

**NOTICE:** The UPS is equipped with internal batteries. The batteries can be replaced without shutting the UPS down as these are hot-swappable battery trays. Replacement is a safe procedure, isolated from electrical hazards.

**CAUTION:** Consider all Safety Warnings in previous sections of this manual before proceeding with the battery tray replacement.

**NOTE:** Please beware that once the battery tray is disconnected from the UPS, the equipment connected to the output of the UPS is not protected from power outages.

Step 1

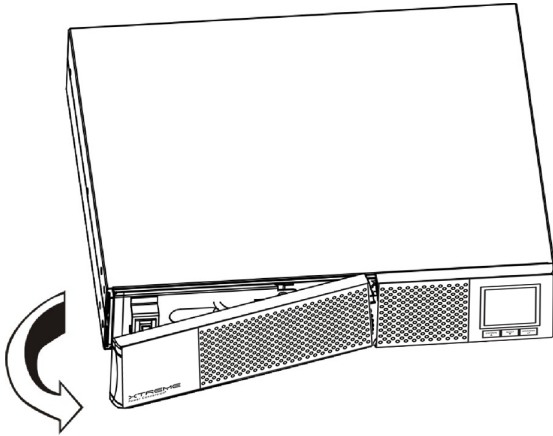

Remove the front panel

Step 2

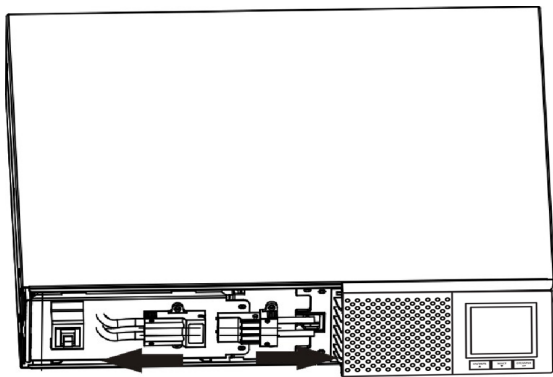

Disconnect the battery tray connector from the UPS

Step 3

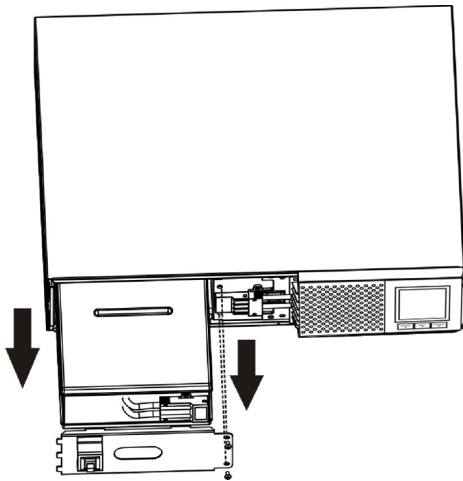

Pull out the battery tray by removing the four screws on the front panel

Step 4

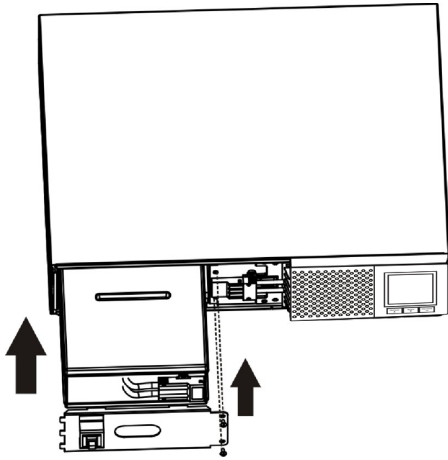

Slide the new battery tray back to the original location in the UPS and secure with the four screws to the front panel

Step 5

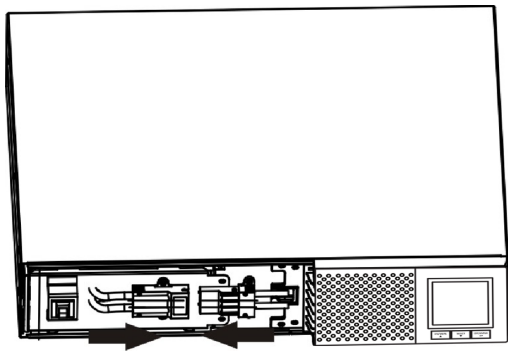

Reconnect the battery tray connector to the UPS

Step 6

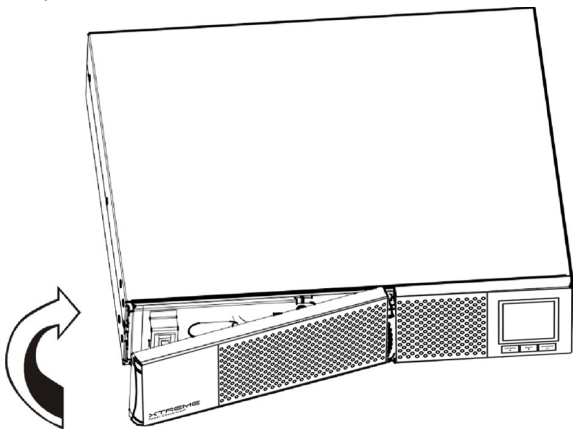

Place the front cover back on the front of the UPS

# Operations



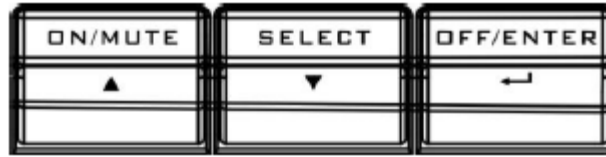





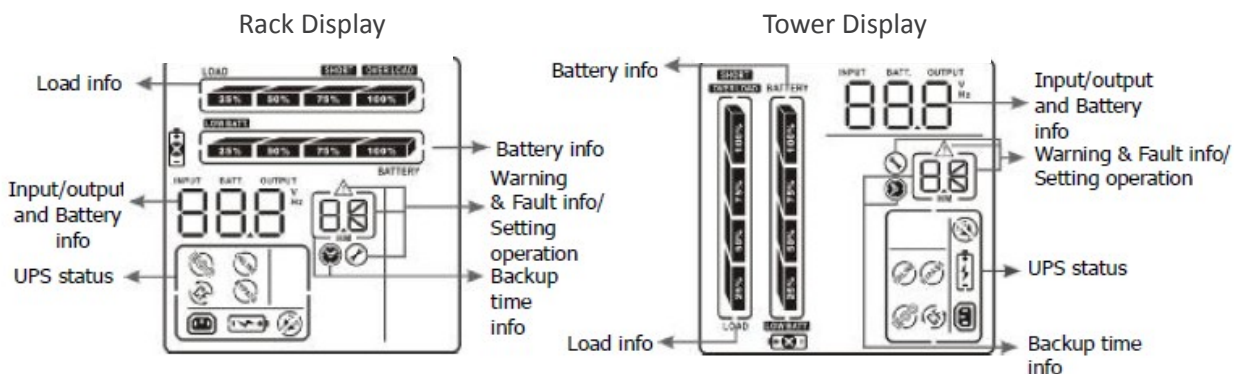







## Button Operation

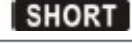



Button	Function
ON/MUTE Button	<ul style="list-style-type: none"> <li>• Turn on the UPS: Press and hold the button more than 2 seconds to turn on the UPS.</li> <li>• Mute the alarm: After the UPS is turned on in battery mode, press and hold this button for at least 5 seconds to disable or enable the alarm system. This feature will not work when warnings or errors occur.</li> <li>• Up key: Press this button to display the previous selection in UPS setting mode.</li> <li>• Switch to UPS self-test mode: Press and hold ON/MUTE button for 5 seconds to enter UPS self-testing while in AC mode.</li> </ul>
OFF/ENTER Button	<ul style="list-style-type: none"> <li>• Turn off the UPS: Press and hold the button more than 2 seconds to turn off the UPS. The UPS will be in standby mode under normal power or transfer to bypass mode if the Bypass enable setting is set by pressing this button.</li> <li>• Confirm selection key: Press this button to confirm selection in UPS setting mode.</li> </ul>
SELECT Button	<ul style="list-style-type: none"> <li>• Switch LCD message: Press this button to change the LCD message for input voltage, input frequency, battery voltage, output voltage, and output frequency.</li> <li>• Setting mode: Press and hold this button for 5 seconds to enter the UPS setting mode when UPS is off.</li> <li>• Down key: Press this button to display the next selection in UPS setting mode.</li> </ul>
ON/Mute + Select Button	<ul style="list-style-type: none"> <li>• Switch to Bypass mode: When the utility power is normal, press ON/MUTE and SELECT buttons simultaneously for 5 seconds. The UPS will then enter Bypass mode. The Bypass mode will be disabled when the input voltage is out of acceptable range.</li> </ul>

## LCD Panel



Display	Function
Backup time information	
	Indicates the backup time in pie chart.
	Indicates the backup time in numbers. H: hours, M: minutes
Warning & Fault information	
	Indicates that the warning and fault occurs.
	Indicates the warning fault codes, and the codes are listed in details in this manual.
Setting Operation	
	Indicates the setting operation.
Input / Output & Battery information	
	Indicates the output/input voltage, output/input frequency or battery voltage. V: output voltage, Hz: frequency
Load information	
	Indicates the load level by 0-25%, 26-50%, 51-75%, and 76-100%.
	Indicates overload.
	Indicates the load or the UPS output is short circuited.
UPS Status	
	Indicates that programmable management outlets are working.
	Indicates the UPS is working in online mode.
	Indicates the UPS is working in converter mode.
	Indicates the UPS is working in bypass mode.
	Indicates the UPS is powering the output directly from utility.
	Indicates that the UPS alarm is disabled.
	Indicates the battery charger is working.

Battery information	
	Indicates the Battery level by 0-25%, 26-50%, 51-75%, and 76-100%.
	Indicates low battery.
	Indicates there is something wrong with the battery.

### Audible Alarms

Description	Buzzer status
Battery Mode	Sounds every 4 seconds
Low Battery	Sounds every second
Overload	Sounding twice every second
Fault	Continuously sounds

### Abbreviations in LCD Display

Abbreviation	Display	Meaning
ENA	ENA	Enable
DIS	DIS	Disable
ESC	ESC	Escape
RAC	RAC	Rack Display
TOE	TOE	Tower Display
B.L	bL	Low Battery
O.L	OL	Overload
N.C	NC	Battery is not connected
O.C	OC	Overcharge
S.F	SF	Site Fault
E.P	EP	EPO

T.P	EP	Over Temperature
C.H	CH	Charger Failure
B.B	b.b	Battery Fault
F.U	F.U	Frequency Unstable in Bypass Mode
B.V	b.v	Input Voltage is Out of Bypass Range

**UPS Setting**

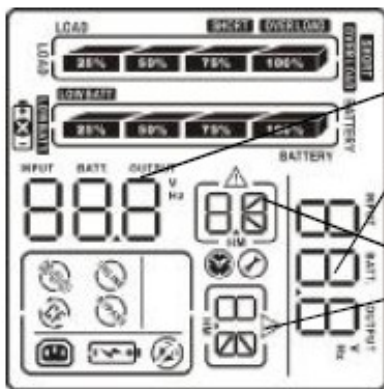

Parameter 2

Parameter 1

There are two parameters to set up the UPS.  
**Parameter 1:** for program alternatives – there are 9 programs to set up.  
**Parameter 2:** for setting information display.

**01: Output Voltage Settings**

Interface	Setting
	<p>You may choose the following output voltage:</p> <ul style="list-style-type: none"> <li><b>100:</b> presents output voltage as 100VAC</li> <li><b>110:</b> presents output voltage as 110VAC</li> <li><b>115:</b> presents output voltage as 115VAC</li> <li><b>120:</b> presents output voltage as 120VAC</li> <li><b>127:</b> presents output voltage as 127VAC</li> </ul>

**02: Frequency Converter enable/disable**

Interface	Setting
 <p>The LCD display shows 'ENA' on the left and '02' on the right. Above the display are two horizontal bars labeled 'LOAD' and 'BATTERY'. Below the display is a small icon of a battery and a circular icon with a diagonal line through it.</p>	<p><b>CF ENA:</b> converter mode enable  <b>CF DIS:</b> converter mode disable</p>

**03: Output Frequency Setting**

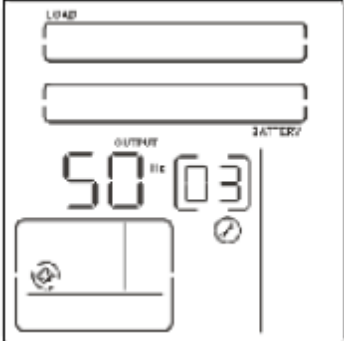
Interface	Setting
 <p>The LCD display shows '50 Hz' on the left and '03' on the right. Above the display are two horizontal bars labeled 'LOAD' and 'BATTERY'. Below the display is a small icon of a battery and a circular icon with a diagonal line through it.</p>	<p>You may set the initial frequency on battery mode:  <b>BAT 50:</b> sets output frequency to 50Hz  <b>BAT 60:</b> sets output frequency to 60Hz</p> <p>If converter mode is enabled, you may choose the following output frequency:  <b>CF 50:</b> sets output frequency to 50Hz  <b>CF 60:</b> sets output frequency to 60Hz</p>

**04: ECO enable/disable**

Interface	Setting
 <p>The LCD display shows 'ENA' on the left and '04' on the right. Above the display are two horizontal bars labeled 'LOAD' and 'BATTERY'. Below the display is a small icon of a battery and a circular icon with a diagonal line through it.</p>	<p><b>ENA:</b> ECO mode enable  <b>DIS:</b> ECO mode disable</p>



**05: AECO enable/disable**

Interface	Setting
	<p><b>ENA:</b> Advanced ECO mode enable  <b>DIS:</b> Advanced ECO mode disable</p>

**06: Bypass Mode enable/disable**

Interface	Setting
	<p><b>ENA:</b> Bypass mode enable  <b>DIS:</b> Bypass mode disable</p>

**07: Programmable Outlets enable/disable**

Interface	Setting
	<p><b>ENA:</b> Programmable outlets enable  <b>DIS:</b> Programmable outlets disable</p>

**08: Programmable Outlets Setting**

Interface	Setting
 <p>The LCD display shows two empty bars at the top labeled 'LOAD' and 'BATTERY'. Below them, the number '128' is displayed on the left and '08' is displayed on the right. At the bottom, there are two circular icons and a small square icon on the left.</p>	<p><b>0-999:</b> setting the backup time limits in minutes from 0-999 for programmable outlets connected to non-critical devices when operating in battery mode.</p>

**09: LCD Display Direction Setting**





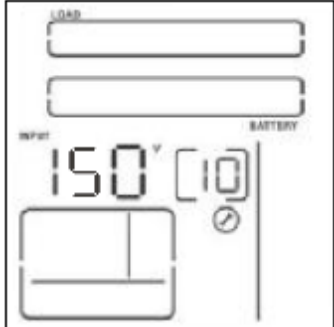



Interface	Setting
 <p>The LCD display shows two empty bars at the top labeled 'LOAD' and 'BATTERY'. Below them, the text 'RAC' is displayed on the left and '09' is displayed on the right. At the bottom, there is one circular icon and a small square icon on the left.</p>	<p><b>RAC:</b> the LCD display is horizontal.  <b>TOE:</b> the LCD display is vertical.</p>

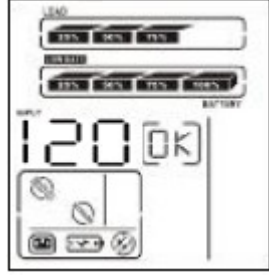

**10: Acceptable Input Voltage Range Setting**

Interface	Setting
 <p>The LCD display shows two empty bars at the top labeled 'LOAD' and 'BATTERY'. Below them, the text 'INPUT' is on the left, '150' is in the center, and '10' is on the right. At the bottom, there is one circular icon and a small square icon on the left.</p>	<p>Choose the following Acceptable input voltage range:  <b>55/150 alternating flashing:</b> acceptable input voltage range is from 55V to 150V  <b>80/130 alternating flashing:</b> acceptable input voltage range is from 80V to 130V  <b>85/135 alternating flashing:</b> acceptable input voltage range is from 85V to 135V</p>

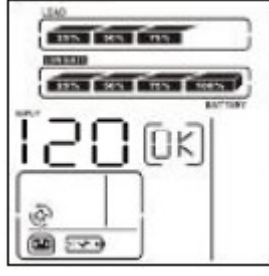
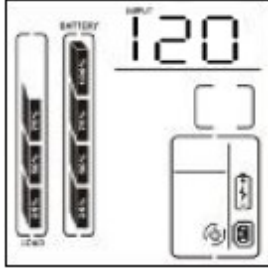
**00: Exit Setting**

### Operating Mode Description



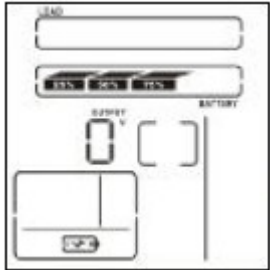
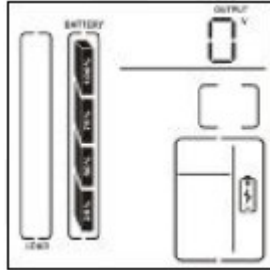
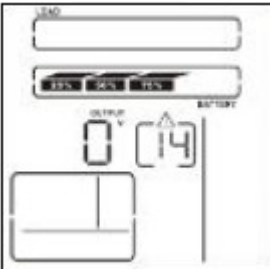
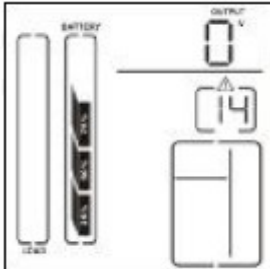







Operating Mode	Description	LCD Display	
		Rack Display	Tower Display
Online Mode	When the input voltage is within acceptable range, the UPS will provide pure and stable AC power to the output. The UPS will also charge the battery during Online Mode.		
ECO Mode (Efficiency Corrective Optimizer)	When the input voltage is within setting range ( $\pm 3\%$ Vo max), UPS will provide voltage to output via static bypass circuit for energy saving. PFC and INVERTER are still active in this mode.		
AECO Mode (Advanced Efficiency Corrective Optimizer)	When the input voltage is within setting range ( $\pm 3\%$ Vo max), UPS will provide voltage to output via static bypass circuit for energy saving. PFC and INVERTER are off in this mode.		
Frequency Converter Mode (Rack)	When input frequency is within 40Hz to 70 Hz, the UPS can be set at a constant output frequency, 50 Hz or 60 Hz. The UPS will still charge battery in this mode. Static bypass circuit is disabled in this mode.		
Battery Mode	When the input voltage is beyond the acceptable range or there is a power failure and alarm is sounding every 4 seconds, the UPS will provide backup power from battery.		

<p>Bypass Mode</p>	<p>When input voltage is within acceptable range but UPS is overloaded, the UPS will enter bypass mode or bypass mode can be set by the front panel. Alarm is sounding every 10 seconds.</p>		
<p>Standby Mode</p>	<p>UPS is powered off without output power, but the battery is still being charged.</p>		
<p>Fault Mode</p>	<p>The UPS is in fault mode when no output power is supplied from the UPS and the fault icon flashes on the LCD display, although the information from the UPS can be displayed on the screen.</p>		

**Fault Reference Codes**





Fault event	Fault code	Icon	Fault event	Fault code	Icon
Bus start failure	01	X	Inverter output short	14	<b>SHORT</b>
Bus over	02	X	Battery voltage too high	27	X
Bus under	03	X	Battery voltage too low	28	
Bus unbalanced	04	X	Over temperature	41	X
Inverter soft start fail	11	X	Overload	43	<b>OVER LOAD</b>
High inverter voltage	12	X			
Low inverter voltage	13	X			

**Warning Indicators**

Warning	Icon (flashing)	Code	Alarm
Low battery		b.L	Sounds every second
Overload		O.L	Sounds twice every second
Battery not connected		N.C	Sounds every second
Overcharge		O.C	Sounds every second
Site wiring fault		S.F	Sounds every second
EPO enable		E.P	Sounds every second
Over temperature		T.P	Sounds every second
Charger failure		C.H	Sounds every second
Battery fault		b.b	Sounds every second
Bypass out of range		b.U	Sounds every second
Bypass frequency unstable		F.U	Sounds every second

## Troubleshooting

If the UPS does not operate correctly, please use the table below to troubleshoot the problems.

Symptom	Possible cause	Remedy
No indication and alarm even though the utility is normal.	The AC input power is not connected well.	Check that the input power cord is firmly connected to the utility.
	The AC input is connected to the UPS output.	Plug the AC input power cord into the AC input utility correctly.
The icon  and the warning code <b>EP</b> are flashing on LCD display and alarm is sounding every second.	EPO function is enabled.	Set the circuit to the closed position to disable EPO function.
The icon  and <b>5F</b> are flashing on LCD display and alarm is sounding every second.	Line and neutral conductors of UPS input are reversed.	Have a qualified electrician correct the input receptacle wiring.
The icon  and  are flashing on LCD display and alarm is sounding every second	The internal battery is incorrectly connected.	Check to make sure all batteries are properly connected.
Fault code is shown as 27 and the icon  is showing on LCD display and alarm is continuously sounding.	Battery voltage is too high or the charger is in fault condition.	Contact your dealer for support.
Fault code is shown as 28 and the icon  is showing on LCD display and alarm is continuously sounding.	Battery voltage is too low or the charger is in fault condition.	Contact your dealer for support.
The icon  and <b>OVER LOAD</b> are flashing on LCD display and alarm is sounding twice every second.	UPS is in overload.	Remove excess loads from UPS output.
	UPS is in overload. Devices connected to the UPS are being fed directly from the electrical utility via the Bypass	Remove excess loads from UPS output.
	After repetitive overloads, the UPS is locked in the Bypass mode. Connected devices are being fed directly by the electrical utility.	Remove excess loads from UPS output, then shut down the UPS and restart.
Fault code is shown as 43 and the icon <b>OVER LOAD</b> is showing on LCD display and alarm is sounding continuously.	The UPS shut down automatically because of the overload condition on the UPS output.	Remove excess loads from the UPS output and restart the UPS.
Fault code is shown as 14 and alarm is sounding continuously.	The UPS shut down automatically because short circuit condition occurred on the UPS output.	Disconnect loads and check output wiring or connected devices are in short circuit status.

<p>Fault code is shown as 01, 02, 03, 04, 11, 12, 13 and 41 on LCD display and alarm is sounding continuously.</p>	<p>A UPS internal fault has occurred. There are two possible results:</p> <ol style="list-style-type: none"> <li>1. The load is still supplied, but directly by AC utility via bypass.</li> <li>2. The load is no longer supplied with power.</li> </ol>	<p>Contact your dealer for support.</p>
<p>Battery backup time is shorter than expected.</p>	<p>Batteries are not fully charged.</p>	<p>Charge the batteries for at least 5 hours and then re-check capacity. If the problem still exists, contact your dealer for support.</p>
	<p>Batteries are defective.</p>	<p>Contact your dealer for battery replacement.</p>

## Storage And Maintenance

### Storage

Before storing, charge the UPS at least 5 hours. Store the UPS covered and upright in a cool, dry location. During storage, recharge the battery in accordance with the following table:

Storage Temperature	Recharge Frequency	Charging Duration
-25°C - 40°C	Every 3 months	1-2 hours
40°C - 45°C	Every 2 months	1-2 hours

### Maintenance



The UPS system operates with hazardous voltages. Repairs may be carried out only by qualified maintenance personnel.



Even after the unit is disconnected from the mains, components inside the UPS system are still connected to the battery packs which are potentially dangerous.



Before carrying out any kind of service and/or maintenance, disconnect the batteries and verify that no current is present and no hazardous voltage exists in the terminals of high capability capacitor such as BUS-capacitors.



Only persons who are adequately familiar with batteries and with the required precautionary measures may replace batteries and supervise operations. Unauthorized persons must be kept away from the batteries.



Verify that no voltage between the battery terminals and the ground is present before maintenance or repair. In this product, the battery circuit is not isolated from the input voltage. Hazardous voltages may occur between the battery terminals and the ground.



Batteries may cause electric shock and have a high short-circuit current. Please remove all wristwatches, rings and other metal personal objects before maintenance or repair, and only use tools with insulated grips and handles for maintaining or repairing.



When replacing the batteries, install the same number and same type of batteries.



Do not attempt to dispose of batteries by burning them. This could cause battery explosion. The batteries must be properly disposed of according to local regulation.



Do not open or destroy batteries. Escaping electrolyte can cause injury to the skin and eyes. It may be toxic.



Please replace the fuse only with the same type and amperage in order to avoid fire hazards.



Do not disassemble the UPS system. The UPS contains no user-serviceable parts.

### Batteries

The life of batteries used in these UPS products is estimated at 3-6 years depending on level of usage and environment. Once the battery is no longer useful and must be replaced, please contact service personnel for assistance.



## Specifications

MODEL NUMBER		P90-1000	P90-1500	P90-2000	P90-3000	P90g-3000
CAPACITY	Power rating	1000VA (900W)	1500VA (1350W)	2000VA (1800W)	3000VA (2700W)	3000VA (2700W)
INPUT	Voltage range	50–150VAC*				110–300VAC*
	Frequency	50/60Hz auto sensing				
	Surge protection	> 800J				
OUTPUT	Voltage	120VAC nominal (100/110/115 selectable)**				208/220/ 230/240VAC***
	Waveform	Pure sine wave, zero transfer time				
	Frequency	50/60Hz ± 0.5Hz				
	THD (full load)	< 2%				
	Efficiency	98% ECO mode, 90% online mode				
	Overload capacity	≤ 130% for 2 min; ≤ 200% for 10 sec; >200% for 1 sec				
BATTERY	Battery type	Sealed, maintenance-free lead acid				
	Battery quantity and size	(2) 12V 9AH	(3) 12V 9AH	(4) 12V 9AH	(6) 12V 9AH	
	Typical recharge	< 4 hours to 90% with 1A charger current				
PHYSICAL	Dimensions (W x D x H)	17.2 x 15.9 x 3.5 in	17.2 x 19.9 x 3.5 in		17.2 x 26.8 x 3.5 in	
	Weight	29.1 lbs	41.7 lbs	47.4 lbs	65.7 lbs	
	Line cord	6 ft, 5–15P	6 ft, 5–15P	6 ft, 5–20P	6 ft, L5–30P	8 ft, C19 to L6–20P
	Receptacles	(8) NEMA 5–15R		(8) NEMA 5–15/20R	(1) NEMA L5–30R + (4) NEMA 5–15/20R	(1) IEC C19 + (6) IEC C13
OPTIONAL BATTERY PACKS	Model number	N/A	P90-BP36 / 36E	P90-BP48	P90-BP72	
	Dimensions (W x D x H)	N/A	17.2 x 19.9 x 3.5 in 17.2 x 24.8 x 3.5 in (E)	17.2 x 19.9 x 3.5 in	17.2 x 24.6 x 3.5 in	
	Weight	N/A	58.1 lbs / 104.4 lbs (E)	74.6 lbs	104.4 lbs	
	Battery	N/A	(6) 12V 9AH / 36V (12) 12V 9AH / 36V (E)	(8) 12V 9AH / 48V	(12) 12V 9AH / 72V	
ENVIRONMENT	Operating temperature	32–104°F (0–40°C)				
	Audible noise	< 45dBA				
	Altitude	11,500 ft above sea level				
APPROVALS	UL, cUL, RoHS				CE, RoHS	
WARRANTY	3 years electronics, 3 years battery warranty (USA and Canada)					
COMMUNICATIONS INTERFACE	RS-232, USB, EPO, intelligent slot for optional cards (Web/SNMP, Relay/dry contact, Modbus)					
INCLUDED IN BOX	Software CD, horizontal brackets, tower pedestals, user manual					
AVAILABLE OPTIONS	5 year extended warranty, bypass distribution (XBDM), power distribution (XPDU), 4-post rail kit, 2-post shelf kit, wall mount bracket					

\*Depending on load level

\*\*P90 capacity derates 20% at 100V output voltage

\*\*\*P90g-3000 capacity derates 20% at 208VAC output voltage

## Shipping List

1. ViewPower CD
2. Horizontal brackets (front)
3. Tower stand brackets
4. Manual
5. 4ft USB cable

## Obtaining Service

If the UPS requires Service:

1. Use the TROUBLESHOOTING section in this manual to eliminate obvious causes.
2. Verify there are no circuit breakers tripped.
3. Call your dealer for assistance. If you cannot reach your dealer, or if they cannot resolve the problem, call Xtreme Power Conversion Corp Technical Support at 800.582.4524. Technical support inquiries can also be made at [support@xpcc.com](mailto:support@xpcc.com). Please have the following information available BEFORE calling the Technical Support Department:
  - Your name and address.
  - The serial number of the unit.
  - Where and when the unit was purchased.
  - All of the model information about your UPS.
  - Any information on the failure, including LED's that may or may not be illuminated.
  - A description of the protected equipment, including model numbers if possible.
  - A technician will ask you for the above information and, if possible, help solve your problem over the phone. In the event that the unit requires factory service, the technician will issue you a Return Material Authorization number (RMA).

If you are returning the UPS to Xtreme Power for service, please follow these procedures:

1. Pack the UPS in its original packaging. If the original packaging is no longer available, ask the Technical Support Technician about obtaining a replacement set of packaging material. It is important to pack the UPS properly in order to avoid damage in transit. Never use Styrofoam beads for a packing material.
2. Include a letter with your name, address, daytime phone number, RMA number, a copy of your original sales receipt, and a brief description of the problem.
3. Mark the RMA number on the outside of all packages. Xtreme Power cannot accept any package without the RMA number marked on the outside of the boxes.
4. Return the UPS by insured, prepaid carrier to the address provided by the Technician.
5. Refer to the Warranty statements in this manual for additional details on what is covered.

## Xtreme Power Conversion Limited Warranty

Xtreme Power Conversion (XPC) Corporation warrants Xtreme Power Conversion equipment, when properly applied and operated within specified conditions, against faulty materials or workmanship for a period of **three years for P90-Series products** from the date of purchase. XPC Corporation warrants **internal batteries for a period of three years** from the date of purchase. For equipment sites within the United States and Canada, this warranty covers repair or replacement, at the sole discretion of XPC Corporation. The customer is responsible for the costs of shipping the defective product to XPC Corporation. XPC Corporation will pay for ground shipment of the repaired or replacement product. This warranty applies only to the original purchaser.

If equipment provided by XPC Corporation is found to be **Dead-on-Arrival (DOA)**, XPC Corporation will be responsible for the costs of shipping product to and returning equipment from the customer in a timely manner as agreed to with the customer, once the customer has requested and received a **Return Material Authorization (RMA)** number. DOA equipment is defined as equipment that does not properly function according to user documentation when initially received and connected in conjunction with proper procedures as shown in the user documentation or via support provided by XPC Corporation personnel or authorized agents.

This warranty shall be void if (a) the equipment is repaired or modified by anyone other than XPC Corporation or a XPC Corporation approved third party; (b) the equipment is damaged by the customer, is improperly used or stored, is subjected to an adverse operating environment, or is operated outside the limits of its electrical specifications; or (c) the equipment has been used or stored in a manner contrary to the equipment's operating manual, intended use or other written instructions. Any technical advice furnished by XPC Corporation or a XPC Corporation authorized representative before or after delivery with regard to the use or application of Xtreme Power Conversion equipment is furnished on the basis that it represents XPC Corporations best judgment under the situation and circumstances, but it is used at the recipient's sole risk.

EXCEPT AS STATED ABOVE, XPC Corporation DISCLAIMS ALL WARRANTIES, EXPRESSED OR IMPLIED, INCLUDING WARRANTIES OF MERCHANTABILITY AND FITNESS FOR A PARTICULAR PURPOSE.

EXCEPT AS STATED ABOVE, IN NO EVENT WILL XPC Corporation BE LIABLE FOR DIRECT, INDIRECT, SPECIAL, INCIDENTAL, OR CONSEQUENTIAL DAMAGES ARISING OUT OF THE USE OF Xtreme Power Conversion EQUIPMENT, including but not limited to, any costs, lost profits or revenue, loss of equipment, loss of use of equipment, loss of software, loss of data, cost of substitutes, or claims by third parties. Purchaser's sole and exclusive remedy for breach of any warranty, expressed or implied, concerning Xtreme Power Conversion equipment, and the only obligation of XPC Corporation under this warranty, shall be the repair or replacement of defective equipment, components, or parts; or, at XPC Corporations sole discretion, refund of the purchase price or substitution of an equivalent replacement product.

## Xtreme Power Conversion Load Protection Policy

THIS POLICY IS NOT A WARRANTY. REFER TO **THE XPC CORPORATION, INC. LIMITED WARRANTY** FOR INFORMATION CONCERNING THE WARRANTY FOR YOUR XPC PRODUCT. THE LIMITATIONS AND CONDITIONS CONTAINED IN THIS POLICY DO NOT AFFECT **THE TERMS OF THE XPC LIMITED WARRANTY**.

### Definitions:

1. "Product" means a Standard 120, 208, or 240 Volt power protection device that is used in the United States and Canada. This policy does not include custom manufactured products.
2. "Power Disturbance" means an AC power line transient (telephone line or Local Area Network, if applicable), spike or surge.
3. "Connected Equipment" properly connected electronic equipment
4. "Fair Market Value" of damaged Connected Equipment as determined by XPC shall be the lower of (a) the average price the same or similar items are being sold for on eBay, (b) the price list of Orion Blue Book (or if such price list is no longer published, a published or announced price list reasonably selected by XPC), (c) the lowest price the same or similar items can be purchased for in the United States or (d) the total amount of all payment(s) you have or are entitled to receive from insurance, other warranties, extended warranties, a legal liability claim or from other sources or persons for the damaged Connected Equipment.
5. "Purchaser" means the person or entity that originally purchased the Product from an authorized reseller or distributor of XPC Products.

The Purchaser of this Product is protected, for the term of the XPC Limited Warranty, against certain losses caused by a Power Disturbance for properly connected electronic equipment (referred to as the "Connected Equipment") subject to certain terms and conditions provided below.

This policy applies only to the original purchaser of the Product. If the Product is transferred or sold to another person or entity, this policy is void.

### Load Protection Policy Dollar and Period Limits

For purchasers that meet the qualifications and conditions set forth in this policy, XPC will provide reimbursement (cost of repair or fair market value as determined by XPC) during the period limits and up to the dollar limits stated as follows:

PRODUCT	DOLLAR LIMIT	PERIOD OF COVERAGE
XVT	25,000	Term of XPC Limited Warranty
XST	25,000	Term of XPC Limited Warranty
S70	25,000	Term of XPC Limited Warranty
XPRT 6kVA & 10kVA	50,000	Term of XPC Limited Warranty
NXRT	50,000	Term of XPC Limited Warranty
P90, P90L, P90g, P90Lg	50,000	Term of XPC Limited Warranty
T90	50,000	Term of XPC Limited Warranty
TX90, TX90i	50,000	Term of XPC Limited Warranty

This Load Protection Policy is not deemed "first dollar" coverage. XPC's obligation is reduced by any amounts that the Purchaser is entitled to recover, from other sources regarding the Connected Equipment, including, but not limited to, insurance, other warranty, extended warranty, or legal liability, regardless of whether or not the Purchaser makes a claim for recovery.

### Eligibility for Coverage Under the Load Protection Policy

1. The Product must be registered on the XPC website, [www.xpcc.com](http://www.xpcc.com), within 10 days of purchase. All required information must be provided, and Purchaser should retain a copy for Purchaser's records. When registering on the website, Purchaser must list all connected equipment that is directly connected to the

product. Only those devices registered in that manner will be covered.

2. All Connected Equipment must be UL or CSA approved.
3. The Product must be plugged into a properly wired and grounded outlet. Use of input surge devices, extension cords, adapters, ground wires, or electrical connections not manufactured by XPC voids the XPC Load Protection Policy. No other surge protection device may be connected to the output sockets of the Product. The installation must comply with all applicable electrical and safety codes set forth pursuant to the NEC.
4. The Product must have undeniable physical evidence of a Power Disturbance that directly and proximately caused the damage;
5. The Connected Equipment must have been damaged by a Power Disturbance on a properly installed, grounded, and National Electric Code, ("NEC"), code-compliant 120, 208, 240 Volt AC power line in the United States or Canada, by a Power Disturbance on standard telephone land line or PBX telephone equipment line that is properly installed and connected to an RJ11 port on the Product; or by a Power Disturbance on a standard Local Area Network connection that is properly installed and connected to an RJ45 port on the Product and (d) is directly plugged into, and properly connected to, the Product in its original condition which was properly operated when a Power Disturbance passed through the Product and (i) exhausts the protection capacity of the Product or (ii) damages the Product.
6. The Load Protection Policy does not apply if the Product has been operated in a failure mode or not in compliance with XPC operating instructions in the Product user's manual, or if the Connected Equipment has not been operated in compliance with the instructions and manuals of its manufacturer/vendor.
7. This policy is null and void if, XPC determines, in its sole discretion, that the Product has been tampered with or altered in any way.

#### **What is Not Covered Under the Load Protection Policy:**

The following damage is not covered by this Policy:

1. Restoration of lost data and reinstallation of software.
2. Damage from a cause other than AC power-line transients, except for damage due to telephone line, Local Area Network, or CATV transients, which is covered only if the Product offers such protection.
3. DAMAGE CAUSED BY FAILURE TO PROVIDE A SUITABLE INSTALLATION ENVIRONMENT FOR THE PRODUCT (INCLUDING, BUT NOT LIMITED TO, LACK OF A PROPER SAFETY GROUND).
4. Damage caused by the use of the Product for purposes other than those for which it was designed.
5. Damage caused by accidents, or natural disasters, including but not limited to, fire, flood, and wind.
6. Damage caused by abuse, misuse, alteration, modification, or negligence.
7. Any labor costs or travel, room and board expenses associated with the repair and/or restoration of lost or damaged hardware, software or data.

**EXCEPT AS EXPRESSLY PROVIDED IN THIS POLICY, XPC SHALL NOT BE LIABLE FOR ANY DAMAGES WHATSOEVER, INCLUDING, BUT NOT LIMITED TO, DIRECT, INDIRECT, SPECIAL, INCIDENTAL, CONSEQUENTIAL, OR MULTIPLE DAMAGES ARISING OUT OF THE USE OF THE PRODUCT OR DAMAGE TO THE CONNECTED EQUIPMENT, REGARDLESS OF THE LEGAL THEORY ON WHICH SUCH CLAIM IS BASED, EVEN IF ADVISED OF THE POSSIBILITY OF SUCH DAMAGE. SUCH DAMAGES INCLUDE, BUT ARE NOT LIMITED TO, LOSS OF PROFITS, LOSS OF SAVINGS OR REVENUE, LOSS OF USE OF THE PRODUCT OR THE CONNECTED EQUIPMENT OR ANY ASSOCIATED EQUIPMENT, LOSS OF SOFTWARE, COST OF CAPITAL, COST OF ANY SUBSTITUTE EQUIPMENT, FACILITIES OR SERVICES, DOWNTIME, THE CLAIMS OF THIRD PARTIES, INCLUDING CUSTOMERS, AND INJURY TO PROPERTY.**

#### **Submitting a Load Protection Policy Claim:**

1. Any claim under the Load Protection Policy must be made within 10 days of the date of alleged damage to the Connected Equipment.
2. Call the XPC technical support department at 1-800- 582-4524 and obtain a Load Protection Policy Returned Material Authorization (RMA) number. Have information on all applicable insurance or other resources of recovery/payment that is available to the Purchaser and the name of the power utility supplier for the location of the Connected Equipment. XPC will forward to the Purchaser a Load Protection Policy claims form, which

must be completed and filed with XPC within 30 days.

- Mark the Load Protection Policy RMA number on the Product the Purchaser is returning.
- Pack the Product in its original packaging or similar packing materials if the original packaging has been discarded. Enclose the completed Load Protection Policy claim form and a copy of the Purchaser's original sales receipt for the Product in the box.
- Mark the RMA number clearly on the outside of the box.
- Ship the Product (one-way shipping charges paid by the Purchaser) to:

XPC Corporation  
230 Yuma Street  
Denver, CO 80223  
Attn: LPP RMA#

3. XPC will evaluate the Product to determine its level of functionality, and will examine the Product for evidence of damage from a Power Disturbance.
  - If XPCs' evaluation provides no evidence of damage from a Power Disturbance, XPC will send to the Purchaser (i) a report summarizing the tests performed and (ii) a rejection of claim notice.
  - If the Product shows evidence of damage from a Power Disturbance, XPC will request that all Connected Equipment for which a Load Protection Policy claim has been submitted, be sent for evaluation to either XPC or an authorized service center. If it is determined that the Connected Equipment has been damaged by a Power Disturbance, XPC will, in its sole discretion, issue payment to the Purchaser for either the cost of repair of the Connected Equipment or the Fair Market Value of the damaged Connected Equipment, up to the dollar limits stated above. XPC reserves the right to require the Purchaser to transfer title and deliver the Connected Equipment to XPC if it chooses to reimburse the Purchaser for the fair market value of the Connected Equipment. XPCs' maximum liability shall be reduced to reflect all such other payments or sources of recovery, whether applied for or not.
4. If XPC issues payment to the Purchaser to have the Connected Equipment repaired, the repair must be performed at a service center that is authorized by the manufacturer of the Connected Equipment. XPC reserves the right to contact the authorized service center directly to discuss repair costs and damage to the Connected Equipment to determine if it was caused by a Power Disturbance and the right to request that the service center forward the Connected Equipment or components of the Connected Equipment to XPC for inspection
5. Unless modified in writing signed by an officer of XPC and the Purchaser, the terms of this policy are the complete and exclusive agreement between the parties, superseding all prior agreements, oral or written, and all other communications between the parties relating to the subject matter of this agreement. No employee of XPC or any other party is authorized to make any representations beyond those made in this agreement concerning the Load Protection Policy.

XPC Corporation  
230 Yuma Street  
Denver, CO 80223  
1.800.582.4524

## Appendix A: P90-BP36, P90-BP48 & P90-BP72 User Guide

### *Important Safety Instructions*

Please comply with all warnings and operating instructions in this manual strictly. Save this manual properly and read carefully the following instructions before installing the unit. Do not operate this unit before reading through all safety information and operating instructions carefully.

- Do not try to repair the unit yourself, contact your local supplier or your warranty will be void.
- To eliminate any overheating of the battery box, keep all ventilation openings free from obstruction and do not place any foreign objects on top of the battery bank. Keep the battery box 20cm away from the wall.
- Make sure the battery box is installed within the proper environment as specified. (0-40°C and 30-90% non-condensing humidity)
- Do not install the battery box under direct sunlight. Your warranty will be void if the batteries fail due to overheating.
- This battery box is not designed for use in dusty, corrosive and salty environment.
- The warranty for this battery bank will be void if water or other liquid is spilled or poured directly onto the battery box. Similarly we do not warrant any damage to the battery box if foreign objects are deliberately or accidentally inserted into the battery box enclosure.
- The battery will discharge naturally if the system is unused for a period of time.
- It should be recharged every 2-3 months if unused. If this is not done, then the warranty will be null and void. During normal operation, the batteries will automatically remain in charged condition.
- Servicing of batteries should be performed or supervised by trained personnel with knowledge of batteries and the required precautions.
- When replacing batteries, it is necessary to replace ALL batteries with the same quantity, type & capacity.
- CAUTION – Do not dispose of battery or batteries in a fire. The battery may explode.
- CAUTION – Do not open or mutilate the batteries. The electrolyte from the batteries is toxic and harmful to the skin and eyes.
- CAUTION – Risk of Electric Shock –Hazardous voltage may exist between battery terminals and ground. Test before touching with bare hands.
- CAUTION – A battery can present a risk of electrical shock and high short circuit current. The following precaution should be observed when working on batteries:
  1. Remove watches, rings, or other metal objects.
  2. Use tools with insulated handles.
  3. Wear rubber gloves and boots.
  4. Do not lay tools or metal parts on top of batteries.
  5. Disconnect charging source prior to connecting or disconnecting battery terminals.
- Do not plug or unplug the battery connector if UPS works in DC (discharging) mode.

### *Product Overview and Setup*

**NOTE:** Before installation, please inspect the unit. Be sure that nothing inside the package is damaged. Please keep the original package in a safe place for future use.



## Rear Panel View

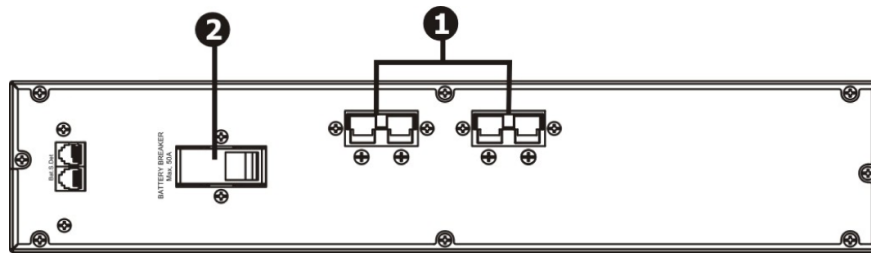

1. DC connector : connects to either UPS or 2nd battery box
2. DC breaker: Battery over-current protection breaker

## Installation and Setup with UPS

### Unpacking & Inspection

1. Remove the battery box from the packing.
  - Note:** The battery box is very heavy, be cautious when unpacking and lifting the unit to avoid injury.
2. Check the inside package
  - Battery box unit
  - Manual
  - Battery connection cable x 1
  - Ear x 2 & screw x 8
  - Extended stand

### Selecting Installation Position

It is necessary to select a proper environment to install the unit, in order to minimize the possibility of damage to the battery box and extend the life of the batteries. Please follow the instructions below:

1. Keep at least 20cm (8 inches) clearance from the rear panel of the unit from the wall or other obstructions.
2. Do not block the air-flow to the ventilation openings of the unit.
3. Please ensure the installation site environmental conditions are in accordance with the unit's working specifications to avoid overheat and excessive moisture.
4. Do not place the unit in a dusty or corrosive environment or near any flammable objects.
5. This unit is not designed for outdoor use.

This unit can either be rack mounted or placed vertically on the desk.

### Rack Installation

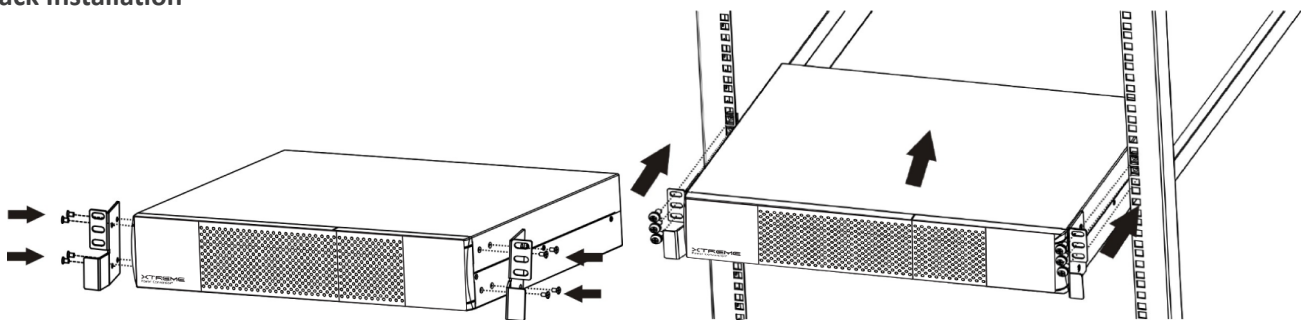



**Tower Installation**

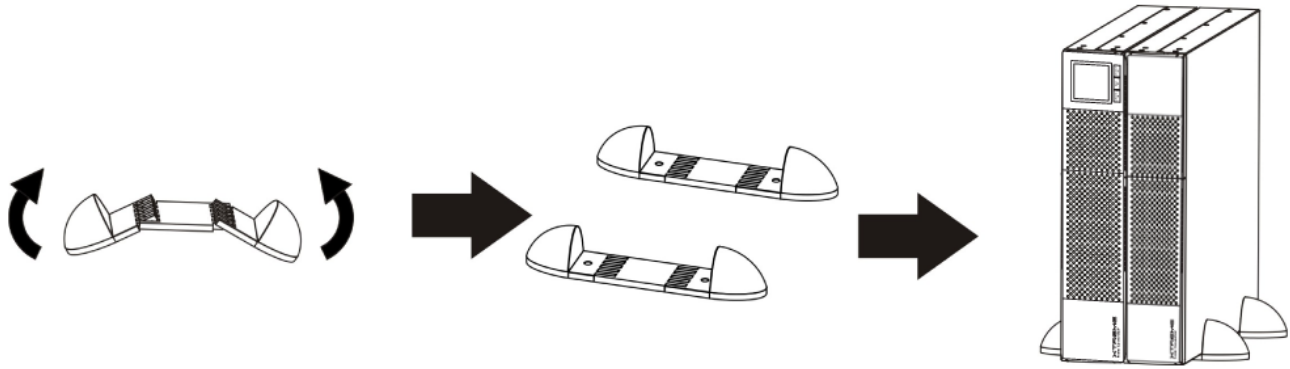

**Connecting with UPS and Other Battery Box**

Follow below installation chart to connect with UPS and other battery box with included cable.

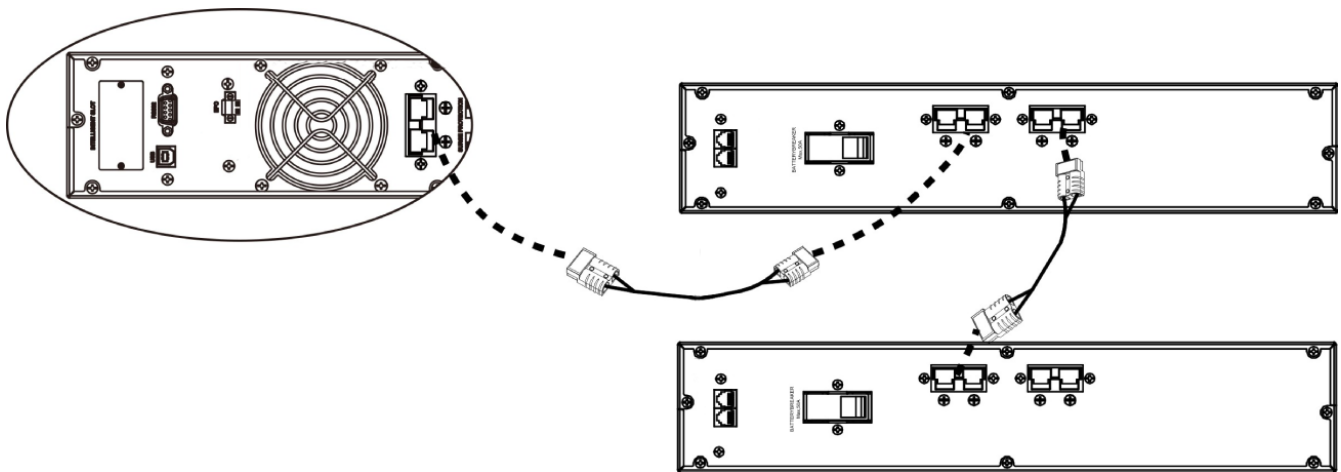

***Type of Battery Required***

This battery box has been designed to operate with the following types of batteries:

- 36V/9Ah Version: 3 pieces of 12V 9Ah batteries per string
- 48V/9Ah Version: 4 pieces of 12V 9Ah batteries per string
- 72V/9Ah Version: 6 pieces of 12V 9Ah batteries per string

***Battery Replacement***

If your battery box is not installed with batteries, please follow proper procedure to put batteries inside of unit.

**NOTE:** MAKE SURE THAT THE BATTERY BOX IS DISCONNECTED FROM THE UPS BEFORE PERFORMING THE FOLLOWING SEQUENCE OF OPERATIONS.

**P90-BP36**

Step 1 : Open the package and place the battery box on a horizontal plane.

Step 2: Remove the removable front panel part by pulling it from the lower extremity.

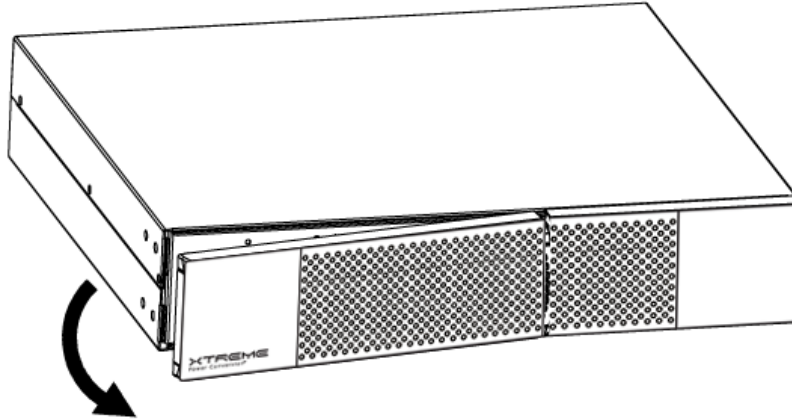

Step 3: Remove the fixed part of the front panel by removing the 2 screw present.

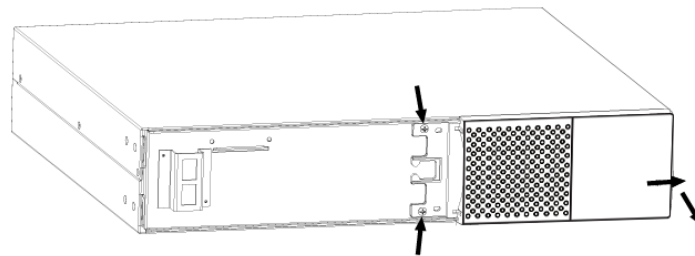

Step 4: Remove the metal top cover of the battery box by unscrewing 6 screws present on the two sides (3 on the right side and 3 on the left side), 3 screws on the top and 4 screws on the back side.

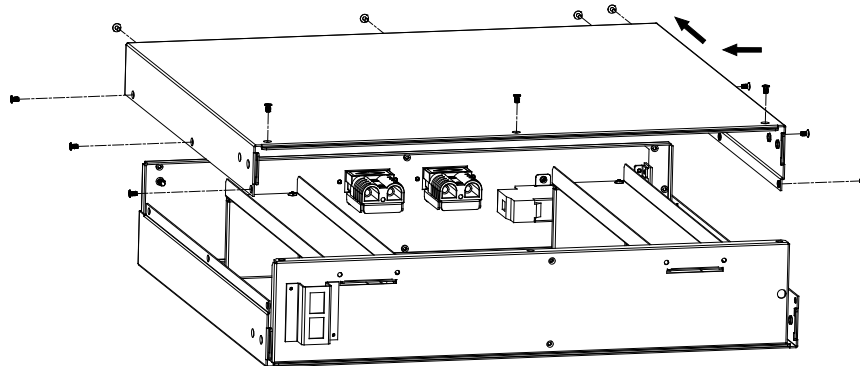

Step 5: Once the battery box is opened, remove the battery hold down brackets present on the left side of the battery box by unscrewing the 2 screws on each bracket.

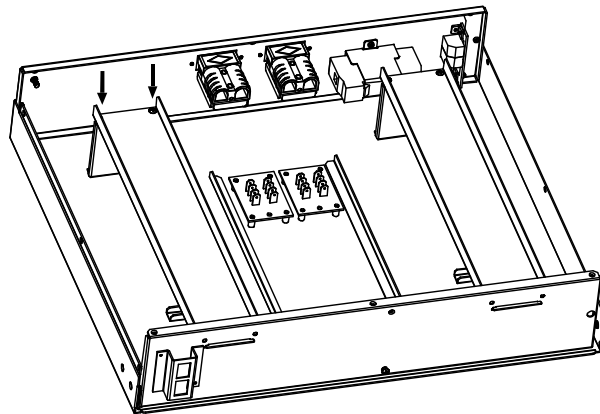

Pull up first and then push the battery fixing plate.

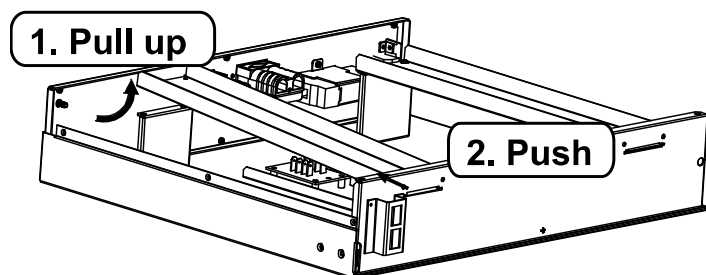

**Note:** To install the second string of batteries, repeat the same procedure on the battery hold down brackets on the right side of the battery box.

Step 6: Now, it is possible to put all batteries inside the unit by following the below picture (the following drawing are indicates the wire fastener positions for the correct battery placement).

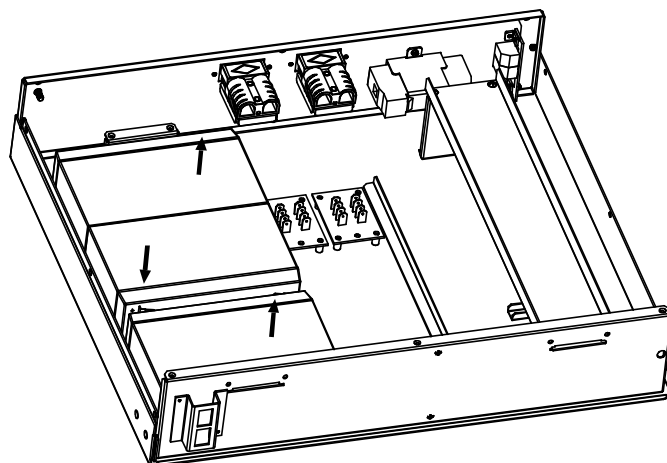

**Note:** To install the second string of batteries, repeat the same procedure on the right side of battery box.

Step 7: Connect all batteries following the wiring diagram shown in next chapter.

Step 8: Put all batteries inside and secure in place with hold down brackets.

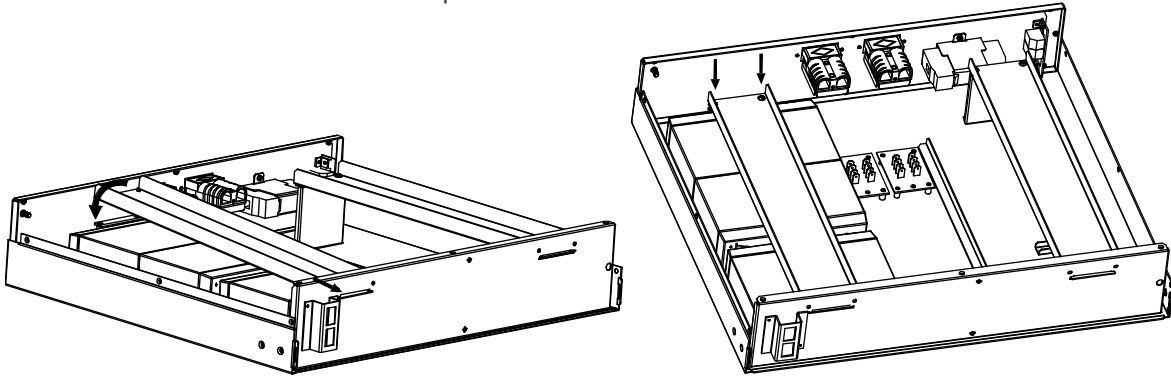

**Note:** To install the second string of batteries, repeat the same procedure on the right side of battery box.

Step 9: Put the metal top cover back on the unit. Close the front fixing plate and the two parts of the front panel and secure it with screws.

Step 10: Connect the battery box to the UPS.

### P90-BP48

Step 1 : Open the package and place the battery box on a horizontal plane.

Step 2: Remove the removable front panel part by pulling it from the lower extremity

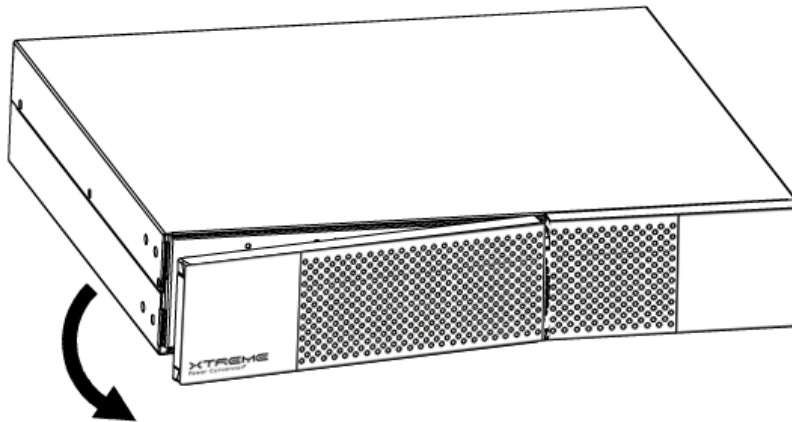

Step 3: Remove the fixed part of the front panel by removing the 2 screw present.

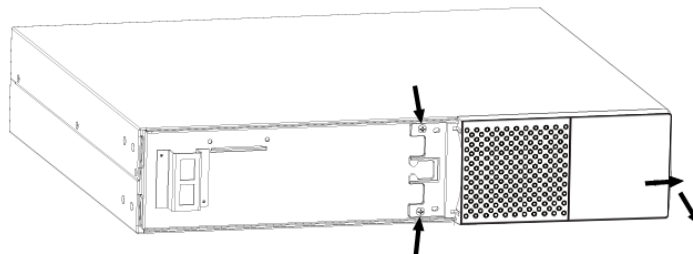

Step 4: Remove the metal top cover of the battery box by unscrewing 8 screws present on the two sides (4 on the right side and 4 on the left side), 3 screws on the top and 4 screws on the back side.

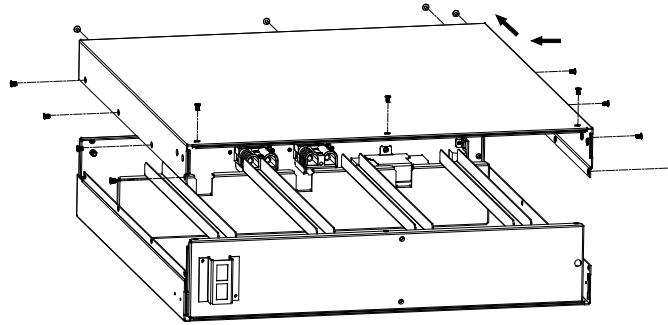

Step 5: Once the battery box is opened, remove the battery hold down brackets present on the left side of the battery box by unscrewing the 2 screws on each bracket.

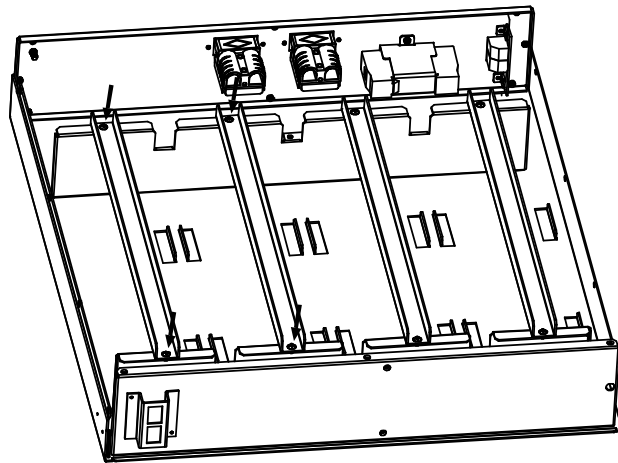

**Note:** To install the second string of batteries, repeat the same procedure on the battery hold down brackets on the right side of the battery box.

Step 6: Now, it is possible to put all batteries inside the unit by following the below picture (the following drawing are indicates the wire fastener positions for the correct battery placement).

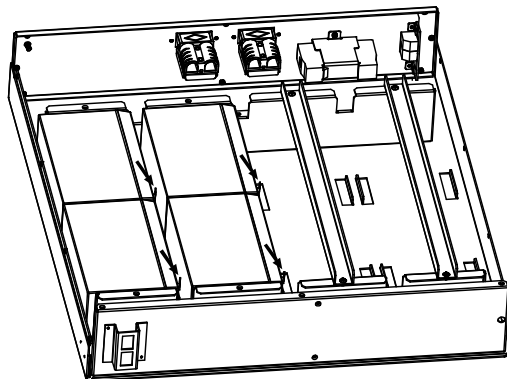

**Note:** To install the second string of batteries, repeat the same procedure on the right side of battery box.

Step 7: Connect all batteries following the wiring diagram shown in next chapter.

Step 8: Put all batteries inside and secure in place with hold down brackets.

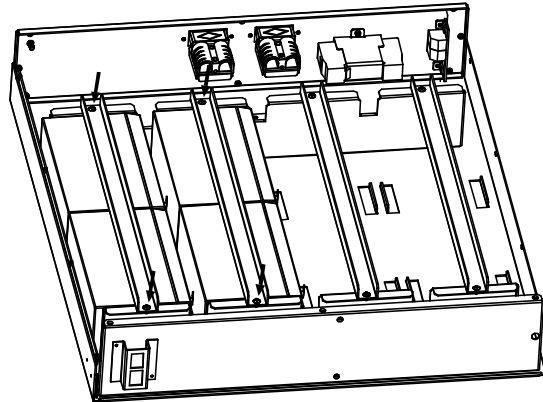

**Note:** To install the second string of batteries, repeat the same procedure on the right side of battery box.

Step 9: Put the metal top cover back on the unit. Close the front fixing plate and the two parts of the front panel and secure it with screws.

Step 10: Connect the battery box to the UPS.

#### P90-BP72

Step 1 : Open the package and place the battery box on a horizontal plane.

Step 2: Remove the removable front panel part by pulling it from the lower extremity

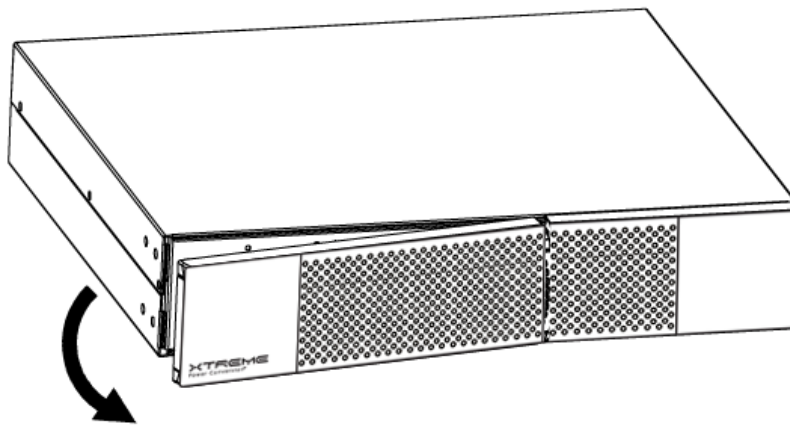

Step 3: Remove the fixed part of the front panel by removing 2 screw present.

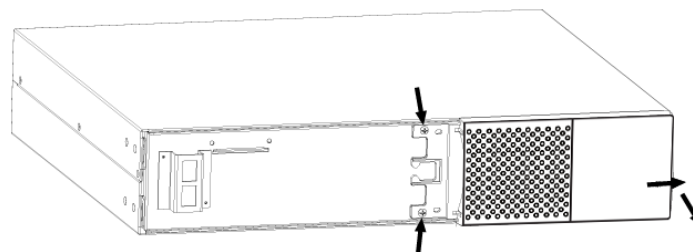

Step 4: Remove the metal top cover of the battery box by unscrewing 8 screws present on the two sides (4 on the right side and 4 on the left side), 3 screws on the top and 4 screws on the back side.

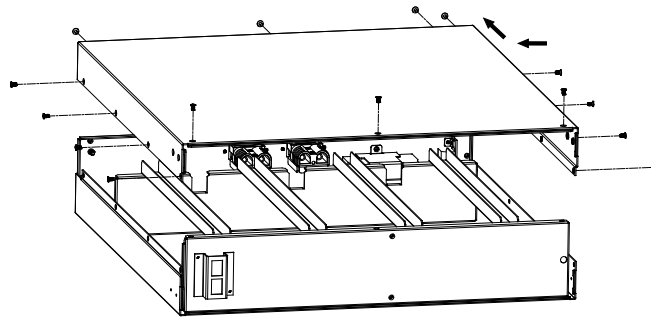

Step 5: Once battery box is opened, remove the battery hold down brackets present on the left side of the battery box by unscrewing the 2 screws on each bracket.

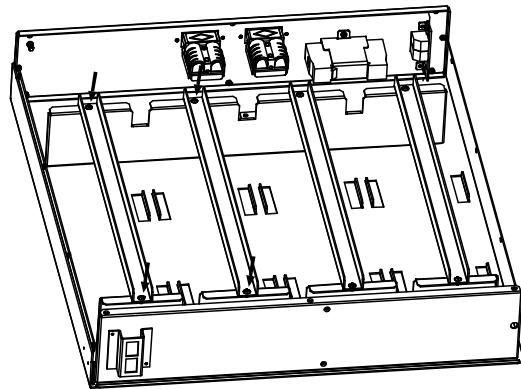

**Note:** To install the second branch of batteries, repeat the same procedure on the battery fixing plate on the right side of battery box.

Step 6: Now, it is possible to put the batteries inside following below picture (in the following drawing are indicated the fasten positions for the correct batteries placing).

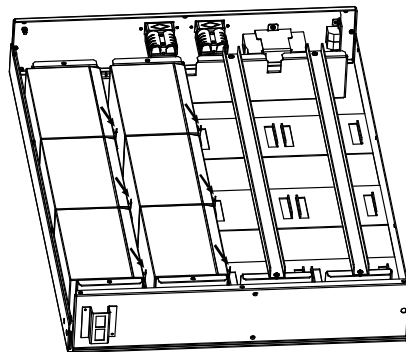

**Note:** To install the second string of batteries, repeat the same procedure on the right side of battery box.

Step 7: Connect all batteries following the wiring diagram shown in next chapter.

Step 8: Put all batteries inside and secure in place with the hold down brackets.

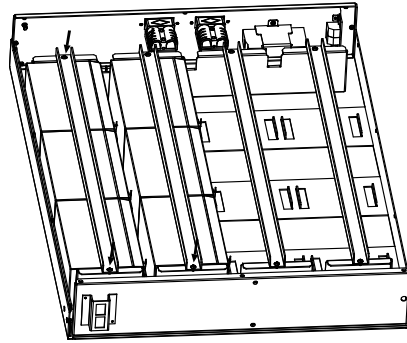

**Note:** To install the second string of batteries, repeat the same procedure on the right side of battery box.

Step 9: Put the metal top cover back on the unit. Close the front fixing plate and the two parts of the front panel and secure it with screws.

Step 10: Connect the battery box to the UPS.

### Wiring Diagram

P90-BP36

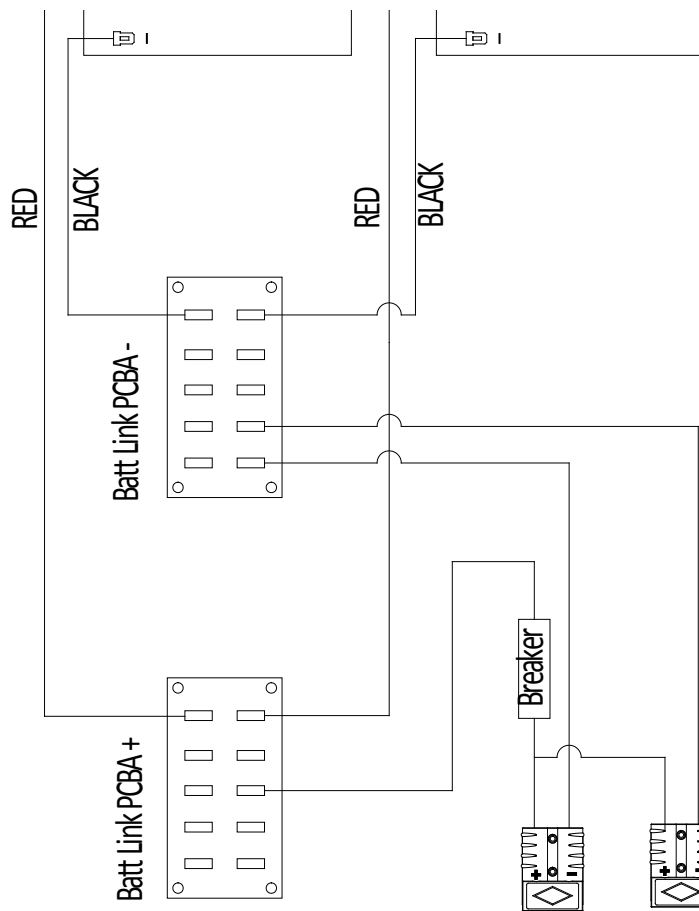



Picture example as below:

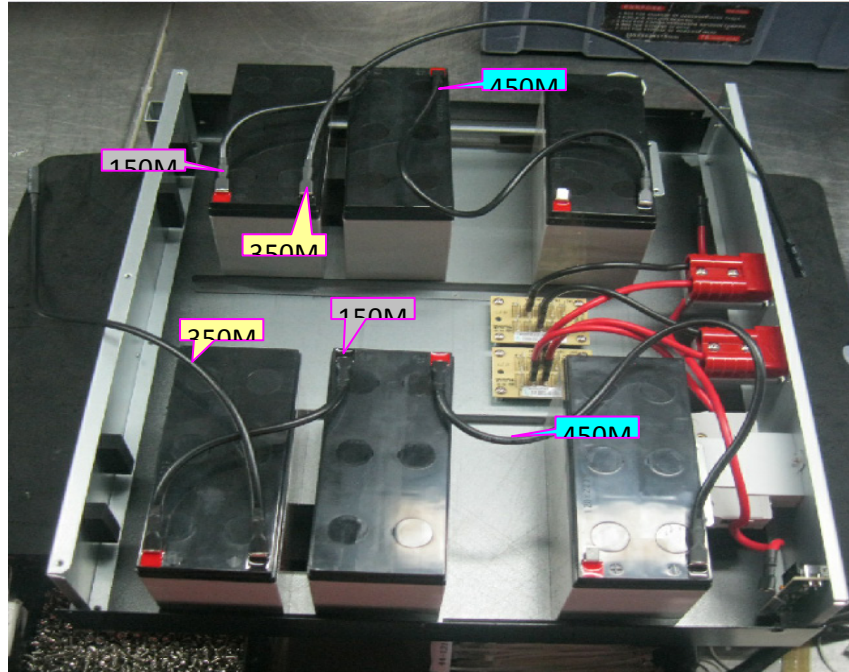

**Note:** The cable connection from the external battery connector to PCB is already present inside the battery box. All the other cable connections should be made in accordance with the above wiring diagram.

**P90-BP48**

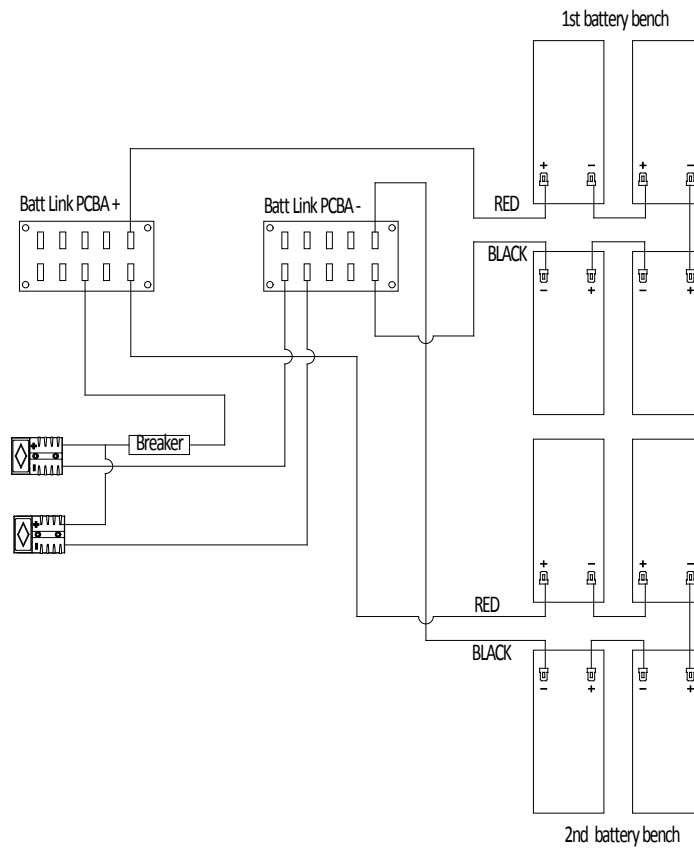

Picture example as below:

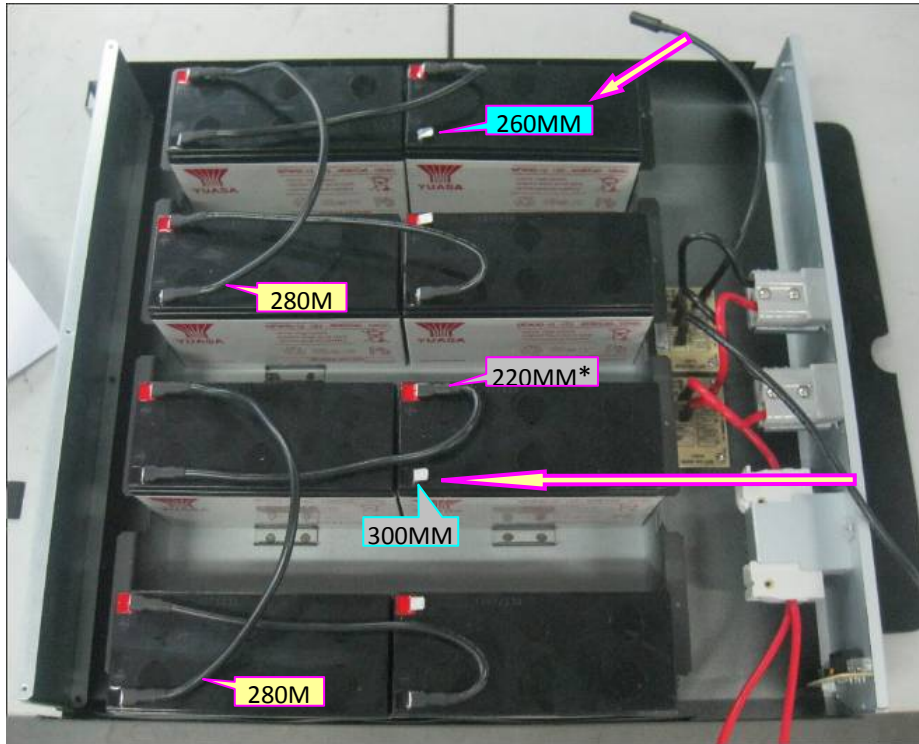

**Note:** The cable connection from the external battery connector to PCB is already present inside the battery box. All the other cable connections should be made in accordance with the above wiring diagram.

**P90-BP72**

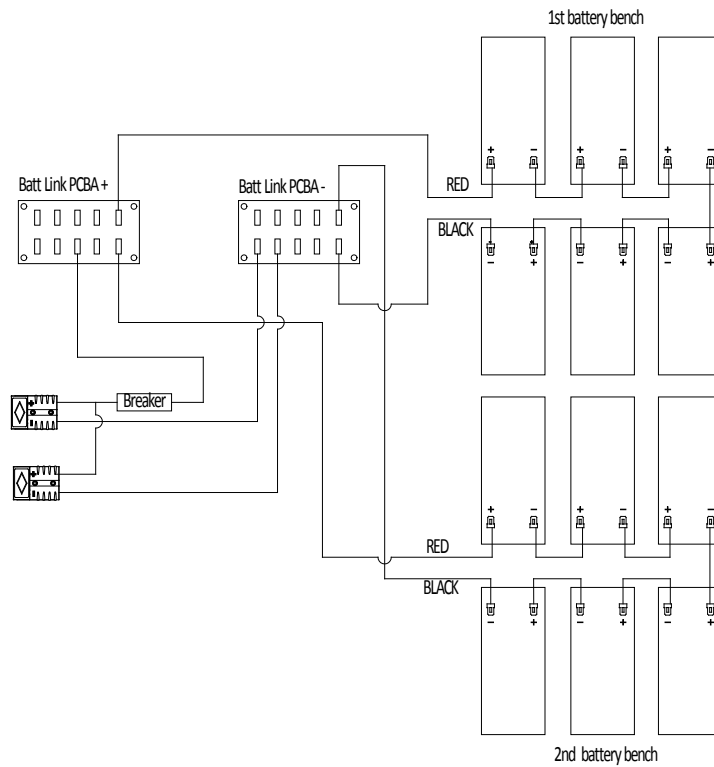

Picture example as below:

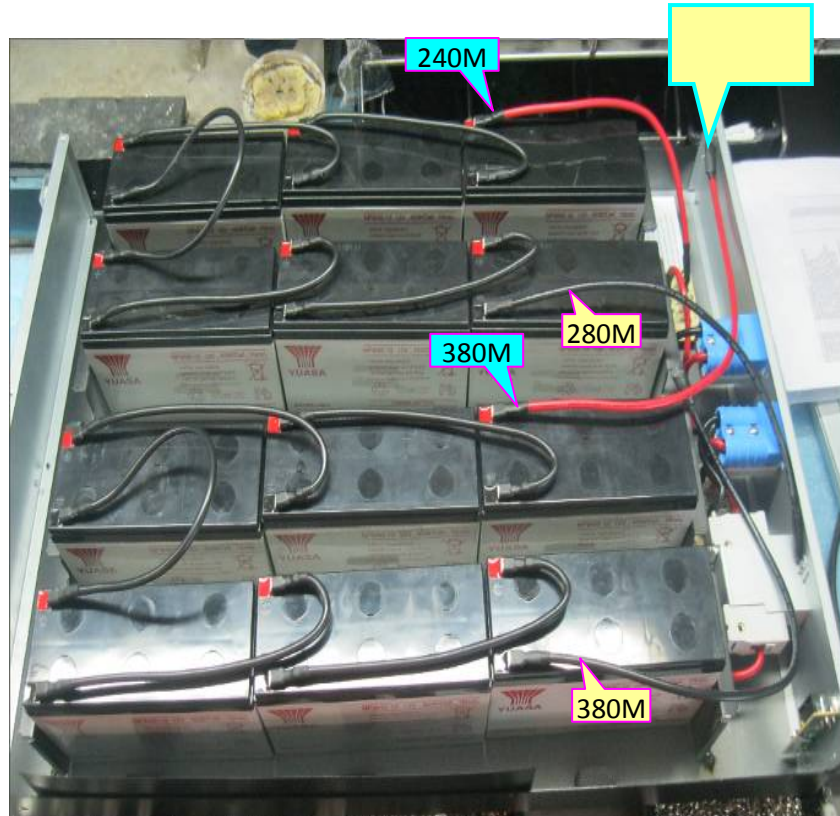

**Note:** The cable connection from the external battery connector to PCB is already present inside the battery box. All the other cable connections should be made in accordance with the above wiring diagram.

**Storage & Maintenance**

The unit contains no user-serviceable parts. If the battery service life (3~5 years at 25°C ambient temperature) has been exceeded, the batteries must be replaced. In this case, please contact your dealer.

Be sure to deliver the spent battery to a recycling facility or ship it to your dealer in the replacement battery packing material.

**Storage**

Before storing, charge the unit 4 hours. Store the unit covered and upright in a cool, dry location. During storage, recharge the battery in accordance with the following table:

Storage Temperature	Recharge Frequency	Charging Duration
-25°C - 40°C	Every 3 months	1-2 hours
40°C - 45°C	Every 2 months	1-2 hours