



P80 Pure Sine Wave Line Interactive UPS

800VA, 1100VA, 1500VA, 2200VA, 3000VA Models

User & Installation Manual

Table of Contents

Important Safety Warning.....	4
Transportation.....	4
Preparation.....	4
Installation.....	4
Operation.....	4
Maintenance, Service, and Faults.....	5
Installation and Setup.....	5
Rear Panel View.....	6
Operating Principle.....	6
Install the UPS.....	7
Setup the UPS.....	10
Battery Replacement.....	12
Battery Kit Assembly.....	15
Operations.....	19
Button Operation.....	19
LCD Panel.....	20
Audible Alarms.....	21
Abbreviations in LCD Display.....	22
UPS Setting.....	22
Operating Mode Description.....	26
Fault Reference Codes.....	27
Warning Indicators.....	27
Troubleshooting.....	28
Storage & Maintenance.....	29
Operation.....	29
Storage.....	29
Specifications.....	30
Obtaining Service.....	31

Xtreme Power Conversion Limited Warranty.....32
Xtreme Power Conversion Load Protection Policy.....33
Appendix A: P90-BP48 & P90-BP72 User Guide.....36

- Important Safety Instructions.....36
- Product Overview and Setup.....36
- Type of Battery Required.....38
- Battery Replacement.....38
- Wiring Diagram.....43
- Storage & Maintenance.....45

Important Safety Warning

Please comply with all warnings and operating instructions in this manual strictly. Save this manual properly and read carefully the following instructions before installing the unit. Do not operate this unit before reading through all safety information and operating instructions carefully.

Transportation

- Please transport the UPS system only in the original package to protect against shock and impact.

Preparation

- Condensation may occur if the UPS system is moved directly from cold to warm environment. The UPS system must be absolutely dry before being installed. Please allow at least two hours for the UPS system to acclimate the environment.
- Do not install the UPS system near water or in moist environments.
- Do not install the UPS system where it would be exposed to direct sunlight or near heater.
- Do not block ventilation holes in the UPS housing.

Installation

- Do not connect appliances or devices which would overload the UPS system (e.g. laser printers) to the UPS output sockets.
- Place cables in such a way that no one can step on or trip over them.
- Do not connect domestic appliances such as hair dryers to UPS output sockets.
- The UPS can be operated by any individuals with no previous experience.
- Connect the UPS system only to an earthed shockproof outlet which must be easily accessible and close to the UPS system.
- Please use only VDE-tested, CE-marked mains cable (e.g. the mains cable of your computer) to connect the UPS system to the building wiring outlet (shockproof outlet).
- Please use only VDE-tested, CE-marked power cables to connect the loads to the UPS system.
- When installing the equipment, it should ensure that the sum of the leakage current of the UPS and the connected devices does not exceed 3.5mA.
- Temperature Rating - Units are considered acceptable for use in a maximum ambient of 40°C (104°F).
- For PLUGGABLE EQUIPMENT, the socket-outlet shall be installed near the equipment and shall be easily accessible.
- CAUTION: The unit is heavy. Lifting the unit requires a minimum of two people.
- Check if there is a protection device against over current and short circuit in the upstream of the UPS system. The recommended protection spec is 11A for 800VA, 1100VA, 15A for 1500VA, 20A for 2000VA, and 30A for 3000VA with a B or C trip curve.

Operation

- Do not disconnect the mains cable on the UPS system or the building wiring outlet (shockproof socket outlet) during operations since this would cancel the protective earthing of the UPS system and of all connected loads.
- The UPS system features its own, internal current source (batteries). The UPS output sockets or output terminals block may be electrically live even if the UPS system is not connected to the building wiring outlet.
- In order to fully disconnect the UPS system, first press the OFF/Enter button to disconnect the mains.
- Prevent no fluids or other foreign objects from inside of the UPS system.

- The EPO, RS-232 and USB circuits are an IEC 60950 safety extra low voltage (SELV) circuit. This circuit must be separated from any hazardous voltage circuits by reinforced insulation.

Maintenance, Service, and Faults

- The UPS system operates with hazardous voltages. Repairs may be carried out only by qualified maintenance personnel.
- **Caution** - risk of electric shock. Even after the unit is disconnected from the mains (building wiring outlet), components inside the UPS system are still connected to the battery and electrically live and dangerous.
- Before carrying out any kind of service and/or maintenance, disconnect the batteries and verify that no current is present and no hazardous voltage exists in the terminals of high capability capacitor such as BUS-capacitors.
- To avoid electrical shock, turn off the unit and unplug it from the AC power source before servicing the battery.
- Only persons are adequately familiar with batteries and with the required precautionary measures may replace batteries and supervise operations. Unauthorized persons must be kept well away from the batteries.
- **Caution** - risk of electric shock. The battery circuit is not isolated from the input voltage. Hazardous voltages may occur between the battery terminals and the ground. Before touching, please verify that no voltage is present!
- Batteries may cause electric shock and have a high short-circuit current. Please take the precautionary measures specified below and any other measures necessary when working with batteries:
 - » Remove wristwatches, rings and other metal objects
 - » Use only tools with insulated grips and handles.
- When changing batteries, install the same number and same type of batteries.
- Do not attempt to dispose of batteries by burning them. This could cause battery explosion.
- Do not open or destroy batteries. Escaping electrolyte can cause injury to the skin and eyes. It may be toxic.
- When replacing batteries, replace with the same type and number of batteries or battery packs.
- Do not dismantle the UPS system.
- A battery can present a risk of electrical shock and high short-circuit current. The following precautions should be observed when working on batteries:
 - » Remove watches, rings, or other metal objects.
 - » Use tools with insulated handles.
 - » Wear rubber gloves and boots.
 - » Do not lay tools or metal parts on top of batteries.
 - » Disconnect charging source prior to connecting or disconnecting battery terminals.
 - » Determine if battery is inadvertently grounded. If inadvertently grounded, remove source from ground. Contact with any part of a grounded battery can result in electrical shock. The likelihood of such shock can be reduced if such grounds are removed during installation and maintenance.

Installation and Setup

NOTE: Before installation, please inspect the unit. Be sure that nothing inside the package is damaged. Please keep the original package in a safe place for future use.

Rear Panel View

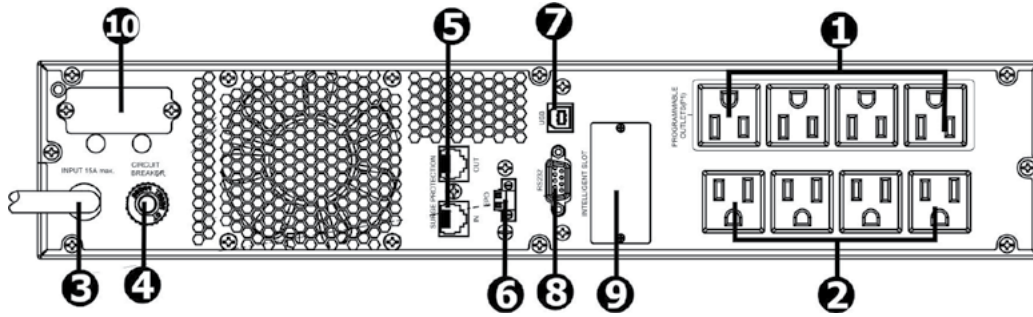

P80-800, P80-1100, P80-1500 Rear View

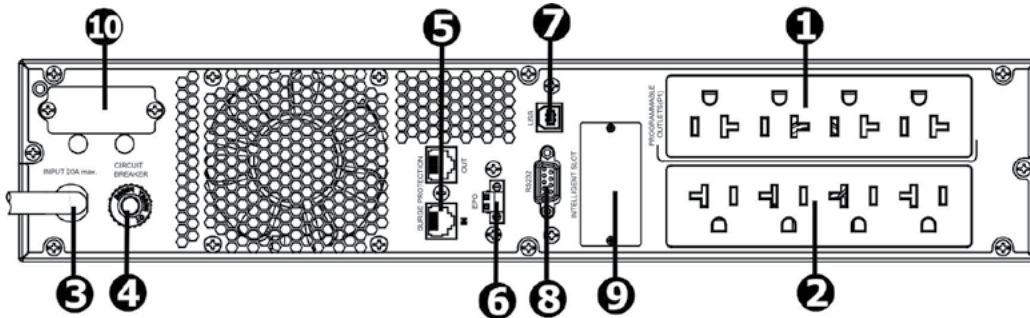

P80-2200, P80-3000 Rear View

1. Programmable outlets: connect to non-critical loads.
2. Output receptacles: connect to mission-critical loads.
3. AC input
4. Input circuit breaker
5. Network/Fax/Modem surge protection
6. Emergency power off function connector (EPO)
7. USB communication port
8. RS-232 communication port
9. SNMP intelligent slot
10. External battery connector

Operating Principle

The operating principle of the UPS is shown as below.

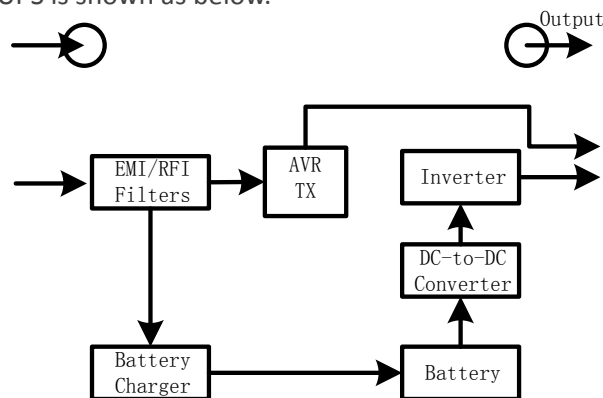

The UPS is composed of mains input, EMI/RFI Filters, Inverter, Battery charger, DC-to-DC converter, battery, AVR TX and UPS output.

Install the UPS

For safety consideration, the UPS is shipped out from factory without connecting battery wires. Before install the UPS, please follow below steps to re-connect battery wires first.

Step 1: Remove front panel.

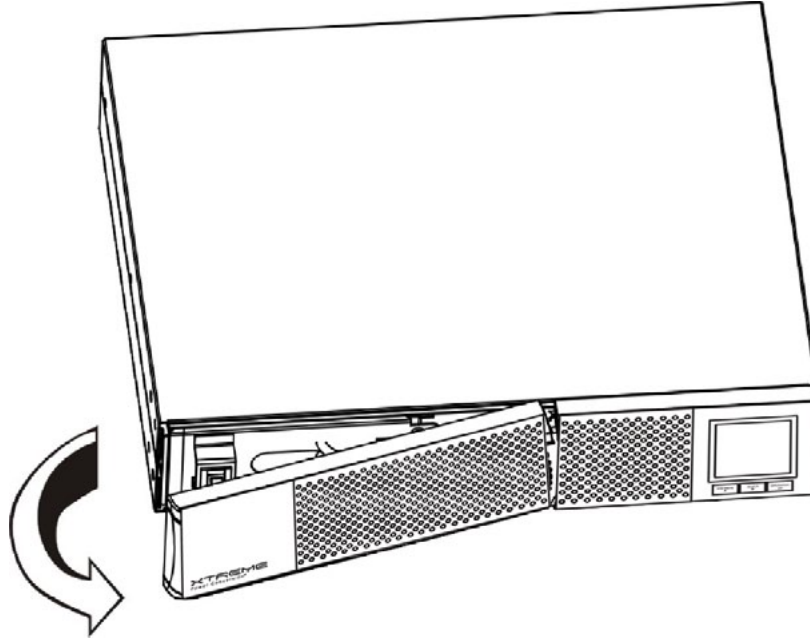

Step 2: Connect the AC input and re-connect battery wires.

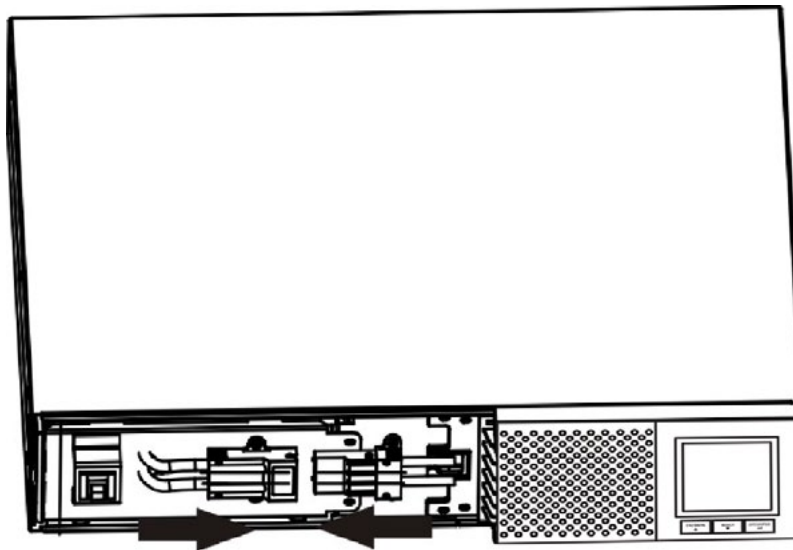

Step 3: Put the front panel back to the unit.

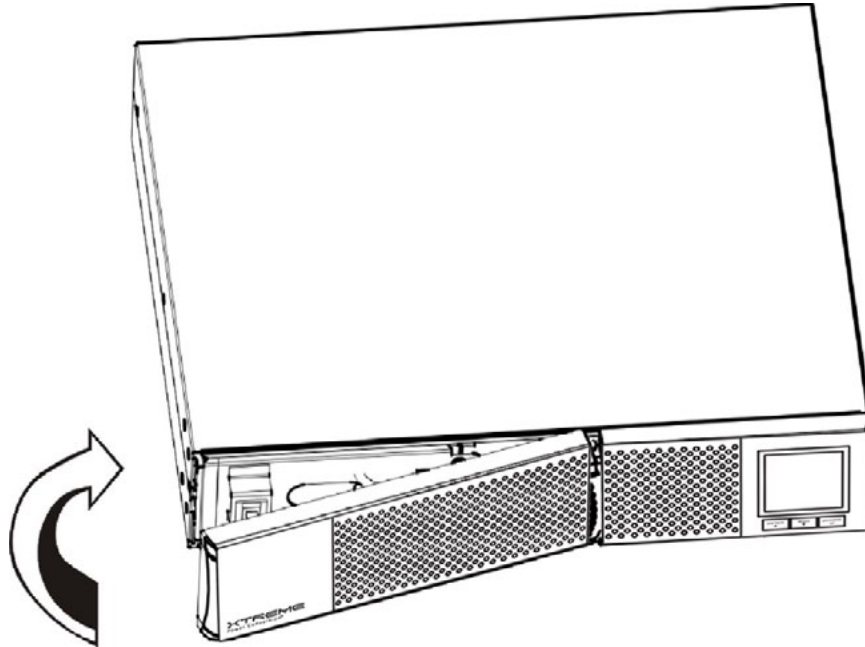

Rack-mount Installation

CAUTION – Do NOT use the mounting brackets to lift the unit. The mounting brackets are only for securing the unit to the rack.

Step 1

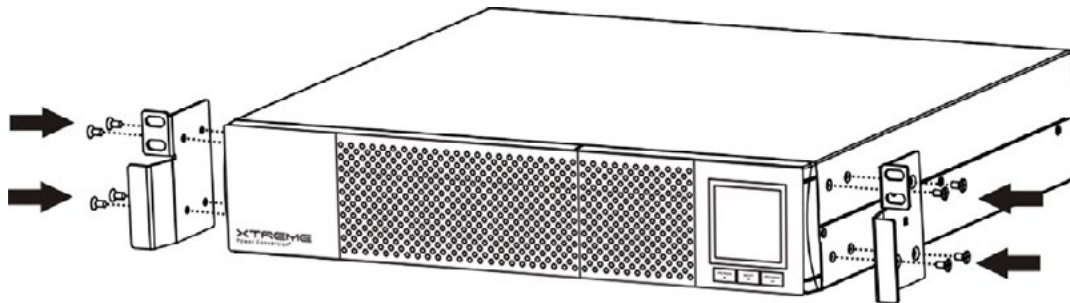

Step 2

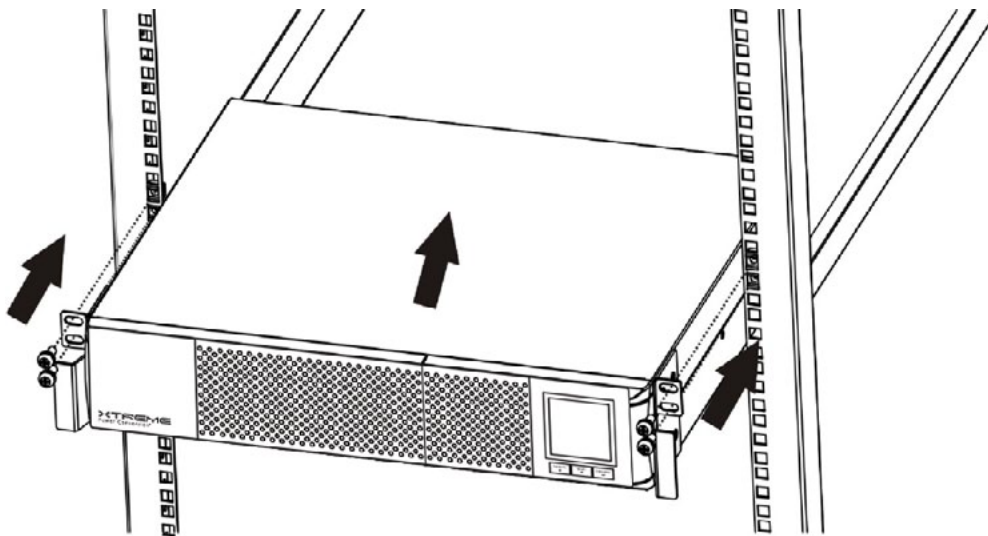

Tower Installation

Step 1

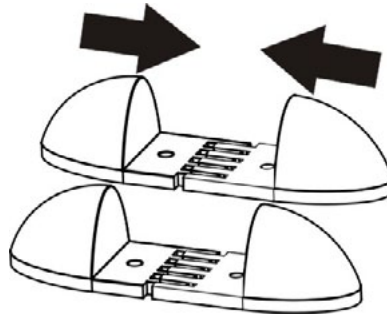

Step 2

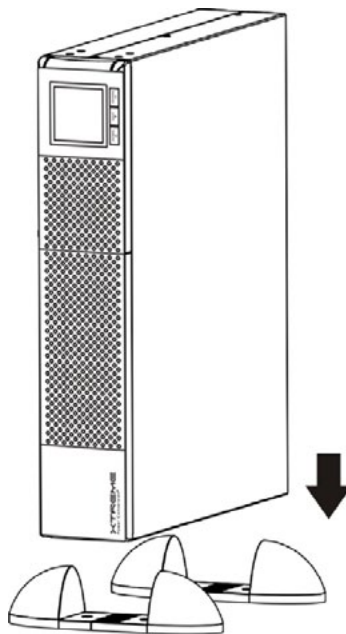

Step 3

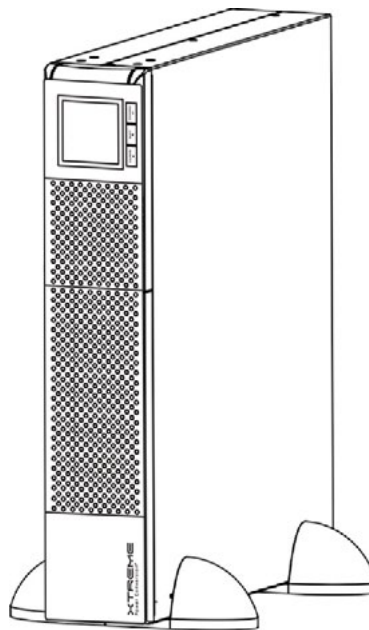

NOTE: When installing the UPS or battery pack with feet, please keep 70mm distance from the edge of the unit.

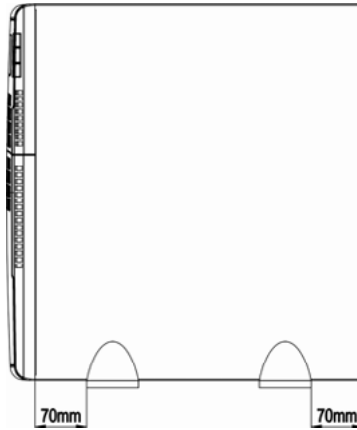

Setup the UPS

UPS input connection

Plug the UPS into a two-pole, three-wire, grounded receptacle only. Avoid using extension cords.

UPS output connection

There two kinds of outputs: programmable outlets and general outlets. Please connect non-critical devices to the programmable outlets and critical devices to the general outlets. During power failure, you may extend the backup time to critical devices by setting shorter backup time for non-critical devices.

Communication connection

Communication ports:

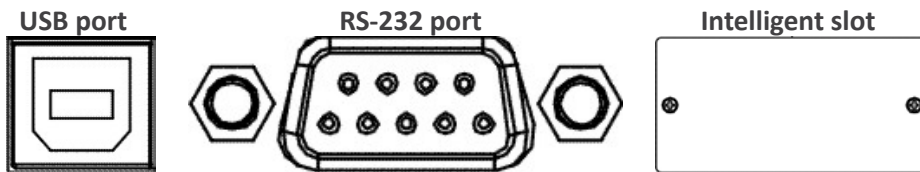

To allow for unattended UPS shutdown/start-up and status monitoring, connect the communication cable one end to the USB/RS-232 port and the other to the communication port of your PC. With the monitoring software installed, you can schedule UPS shutdown/start-up and monitor UPS status through PC.

The UPS is equipped with intelligent slot perfect for either SNMP or Dry Contact/Relay card. When installing either SNMP or Dry Contact/Relay card in the UPS, it will provide advanced communication and monitoring options.

USB port and RS-232 port can't work at the same time.

Surge Protection

Fax/Phone surge port

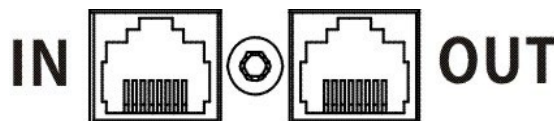

Connect a single modem/phone/fax line into surge-protected "IN" outlet on the back panel of the UPS unit. Connect from "OUT" outlet to the equipment with another modem/fax/phone line cable.

Disable and enable EPO function

Keep the pin 1 and pin 2 closed for UPS normal operation. To activate EPO function, cut the wire between pin 1 and pin 2.

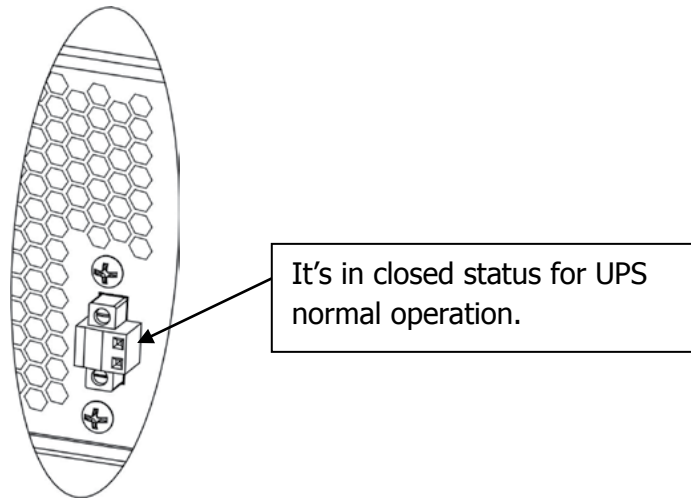
**Step 6: External battery connection**

Connect one end of external battery cable to UPS unit and the other end to battery box. Use supplied battery detection wire in detection port of UPS unit and plug the other end to battery bank.

CAUTION: Connection to External Battery shall be installed by SERVICE PERSONNEL only.

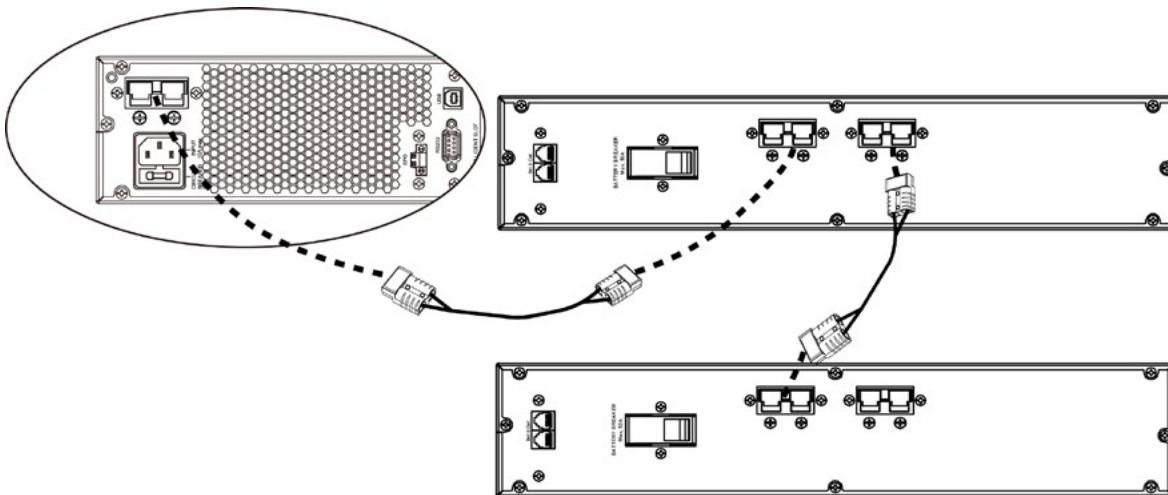

NOTE: It's only allowed to connect external battery boxes up to 1 units.

Step 7: Turn on the UPS

Press the ON/Mute button on the front panel for two seconds to power on the UPS.

Note: The battery charges fully during the first five hours of normal operation. Do not expect full battery run capability during this initial charge period.

Step 8: Install software

For optimal computer system protection, install UPS monitoring software to fully configure UPS shutdown. Please follow steps below to download and install monitoring software:

1. Go to the website <http://www.power-software-download.com>
2. Click ViewPower software icon and then choose your required OS to download the software.

3. Follow the on-screen instructions to install the software.
4. When your computer restarts, the monitoring software will appear as an orange plug icon located in the system tray, near the clock.

Battery Replacement

NOTICE: This UPS is equipped with internal batteries and only service person can replace the batteries.

CAUTION! Consider all warnings, cautions, and notes before replacing batteries.

Note: Upon battery disconnection, equipment is not protected from power outages.

Step 1: Remove front panel.

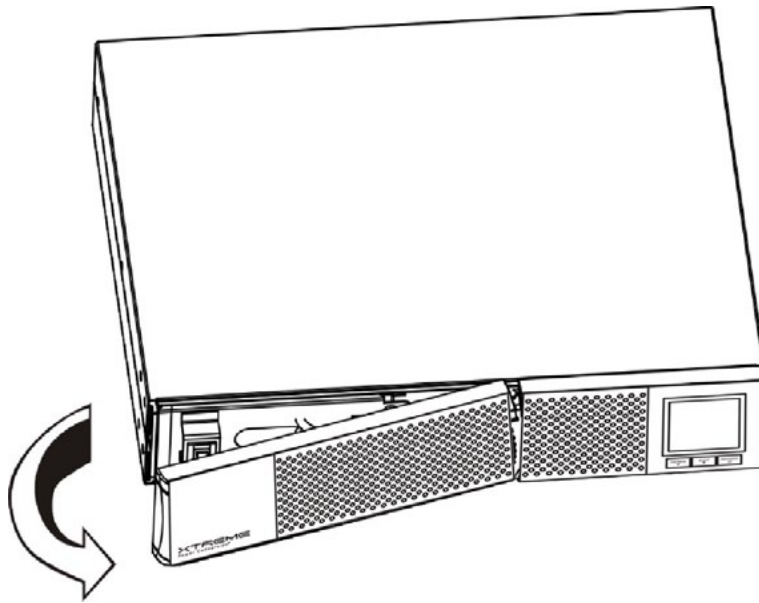

Step 2: Disconnect battery wires.

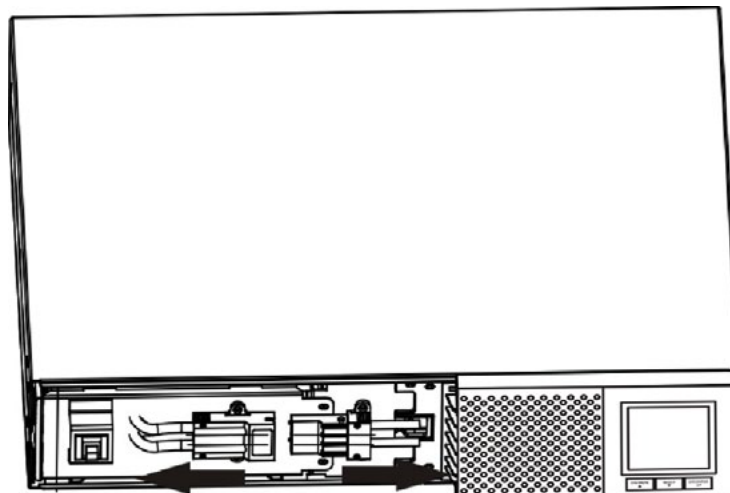

Step 3: Pull out the battery box by removing two screws on the front panel.

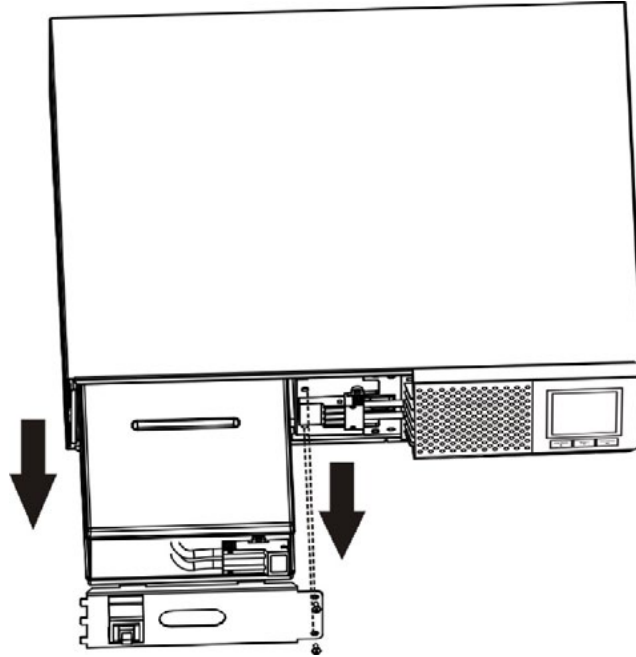

Step 4: Remove the top cover of battery box and replace the inside batteries.

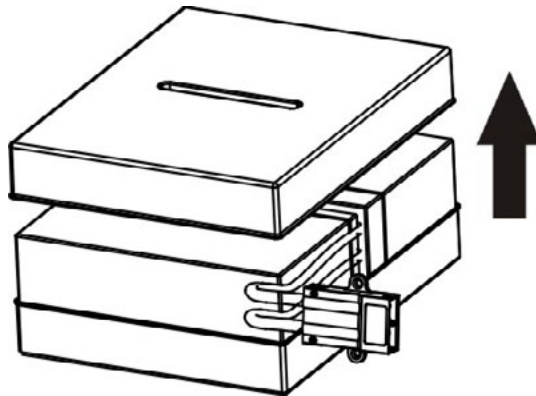

Step 5: After replacing the batteries, put the battery box back to original location and screw it tightly.

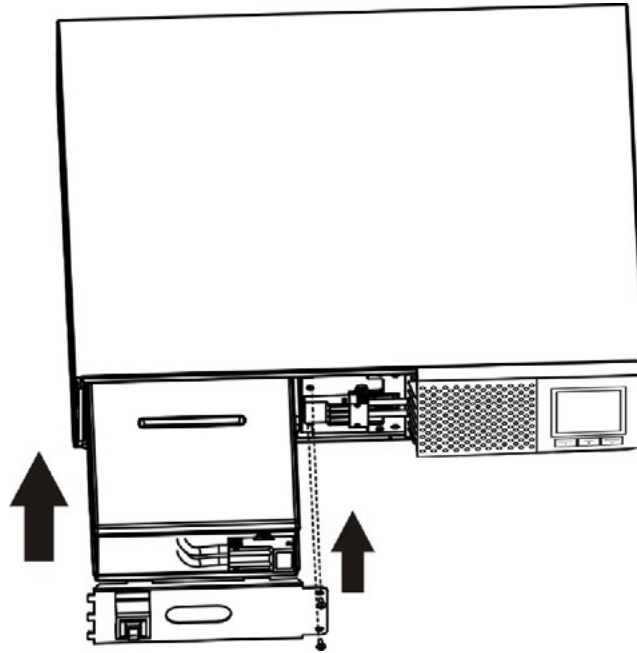

Step 6: Re-connect the battery wires.

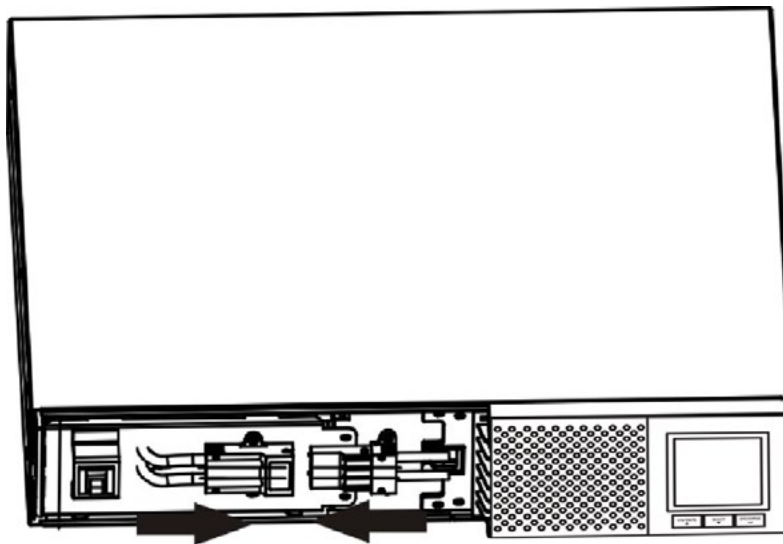

Step 7: Put the front panel back to the unit.

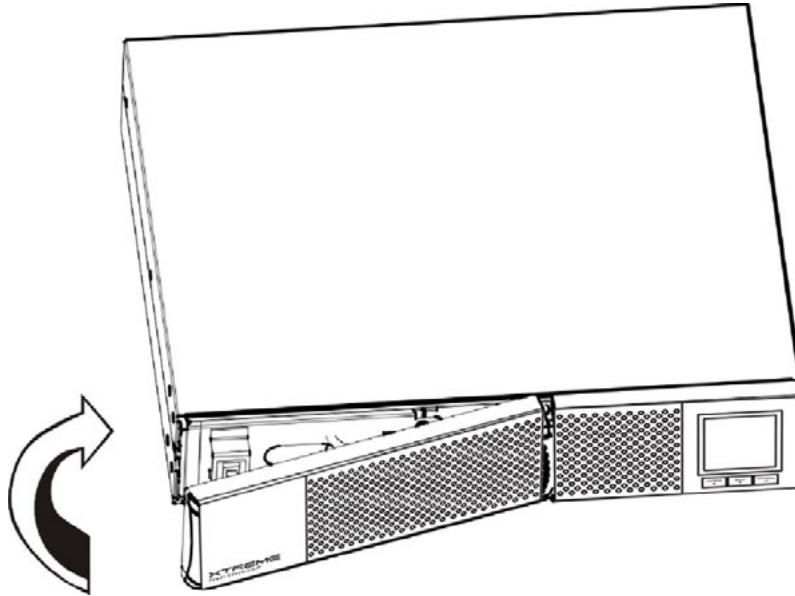

Battery Kit Assembly

NOTICE: Please assemble battery kit first before installing it inside of UPS. Please select correct battery kit procedure below to assemble it.

Two Battery Kit

Step 1: Remove adhesive tapes.

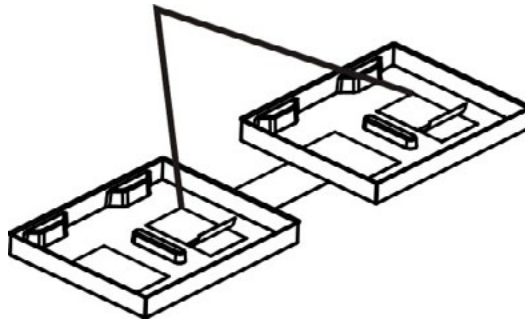

Step 2: Connect all battery terminals by following below diagram.

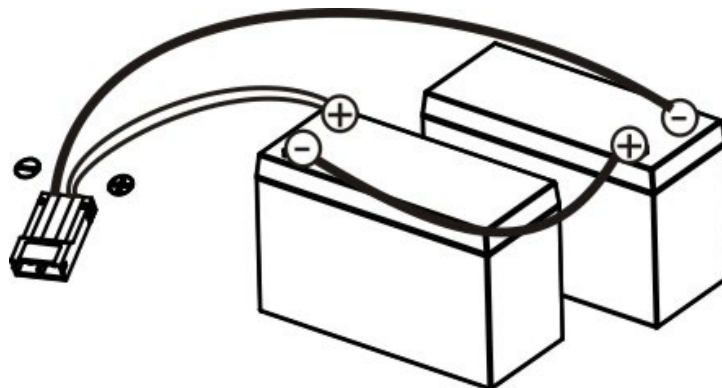

Step 3: Put assembled battery packs on one side of plastic shells and insert one more defect battery on the space.

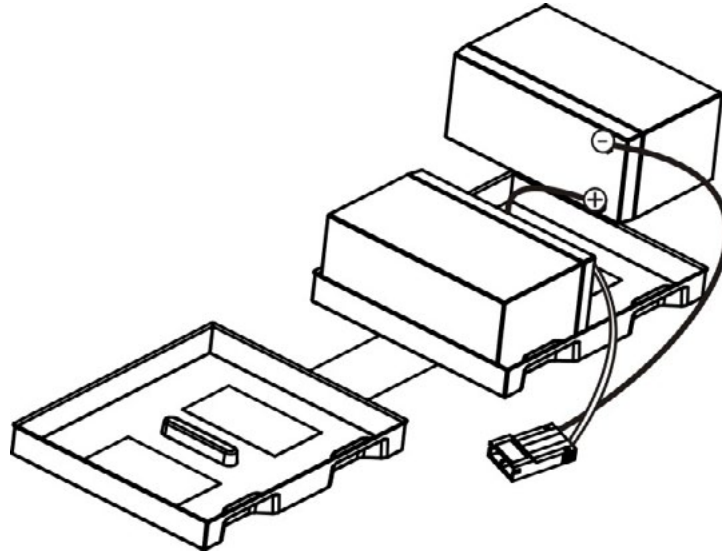

Step 4: Cover the other side of plastic shell as below chart. Then, battery kit is fully assembled.

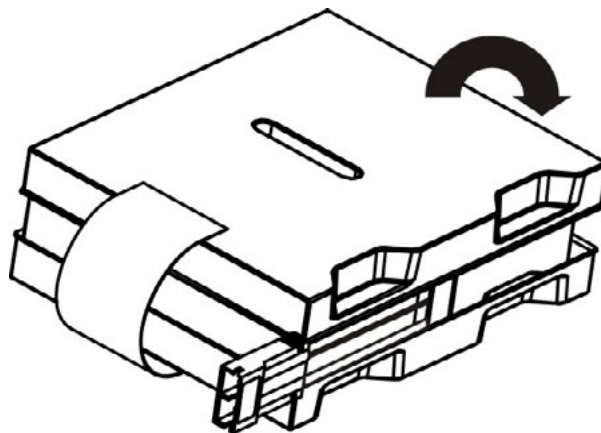

Four Battery Kit

Step 1: Remove adhesive tapes.

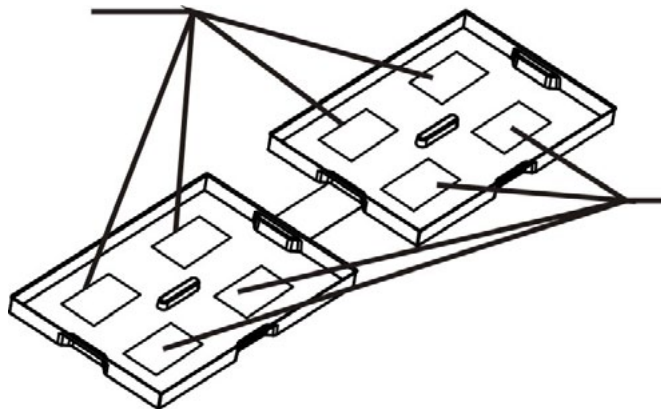

Step 2: Connect all battery terminals by following below diagram.

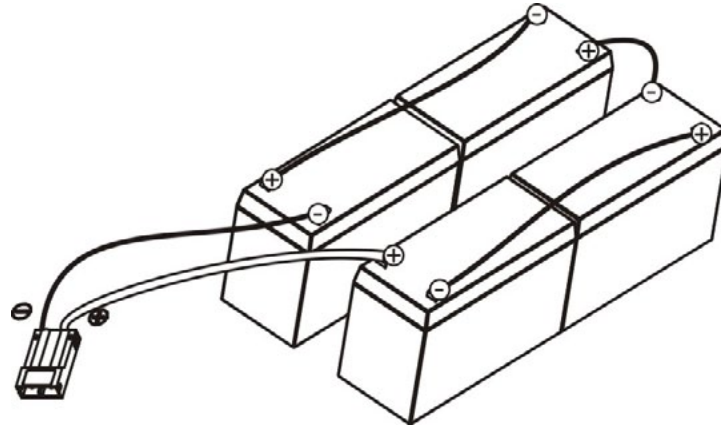

Step 3: Put assembled battery packs on one side of plastic shells.

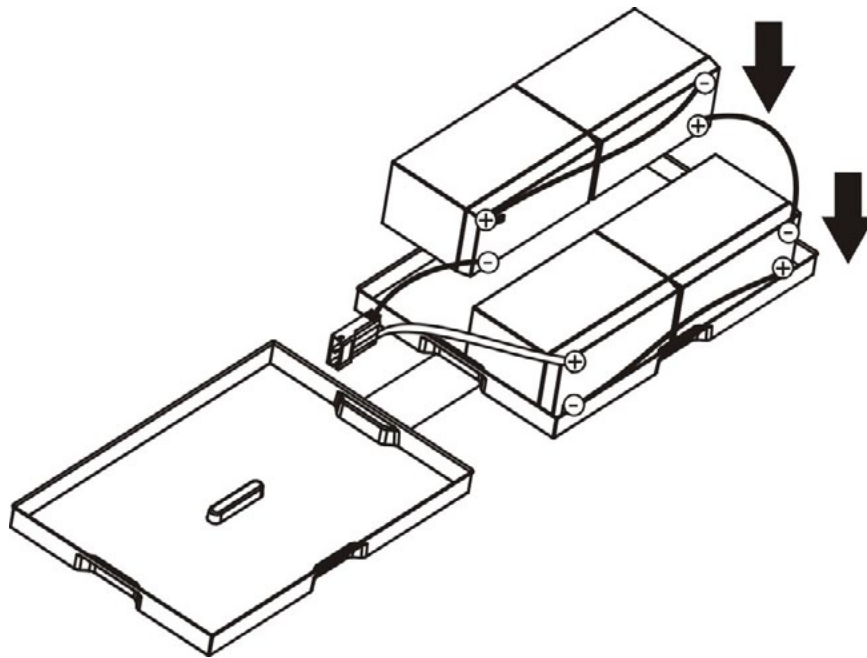

Step 4: Cover the other side of plastic shell as below chart. Then, battery kit is fully assembled.

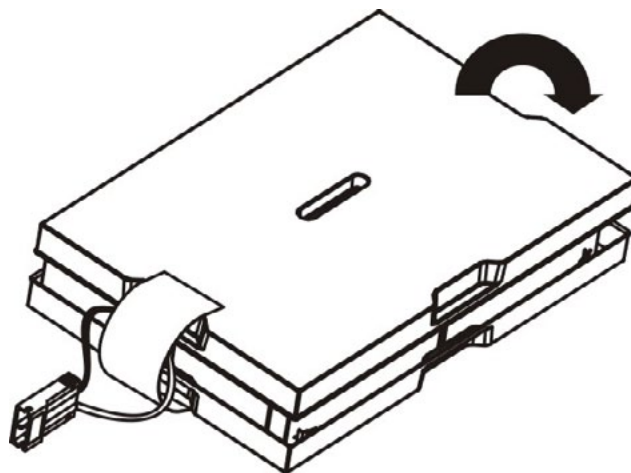

Six Battery Kit

Step 1: Remove adhesive tapes.

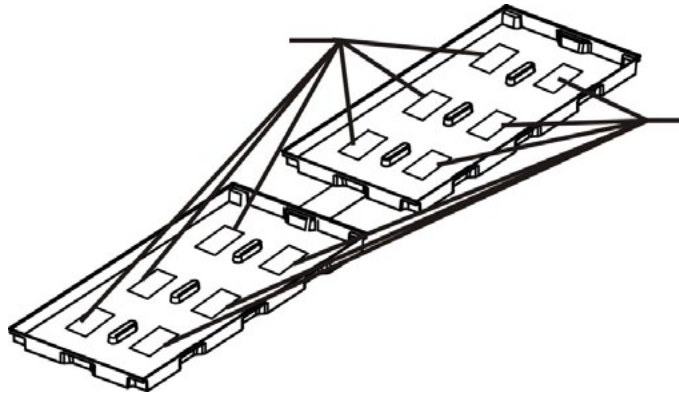

Step 2: Connect all battery terminals by following below diagram.

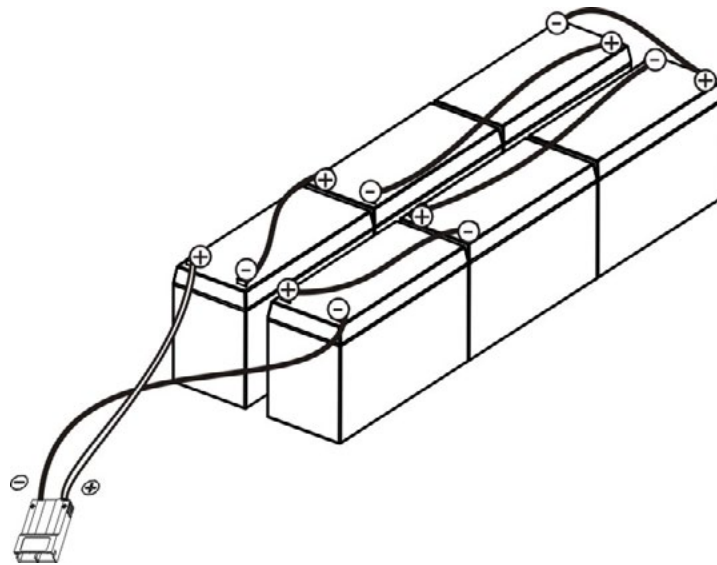

Step 3: Put assembled battery packs on one side of plastic shells.

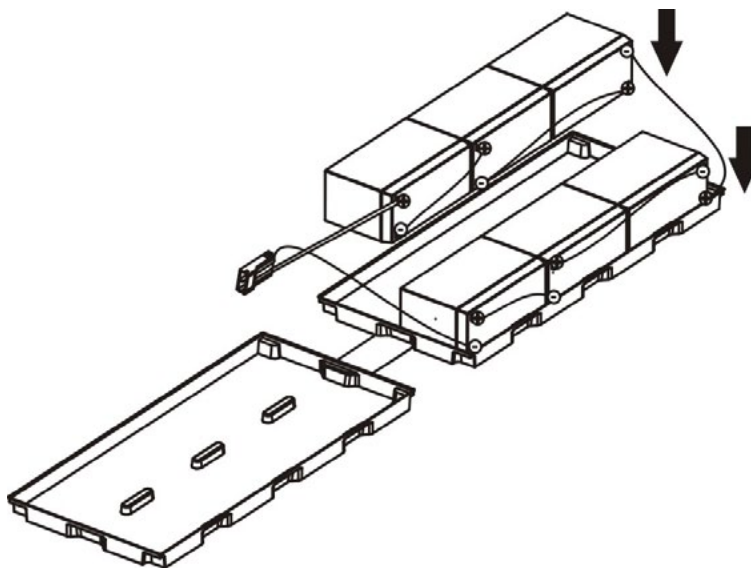

Step 4: Cover the other side of plastic shell as below chart. Then, battery kit is fully assembled.

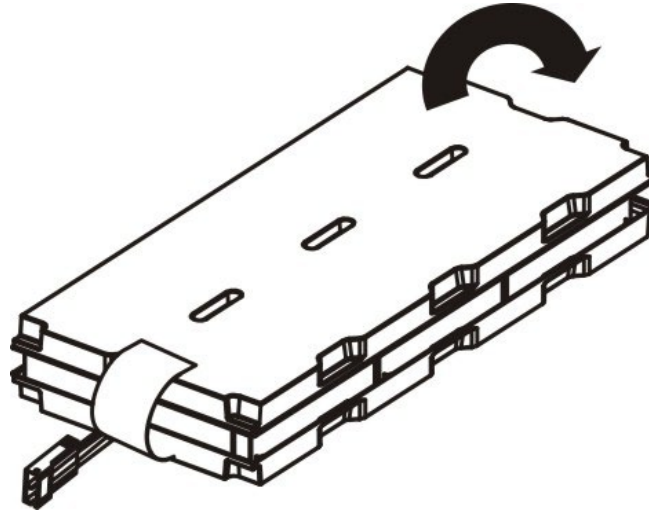

Operations

Button Operation



Button	Function
ON/MUTE Button	<ul style="list-style-type: none"> • Turn on the UPS: Press and hold ON/Mute button for at least 2 seconds to turn on the UPS. • Mute the alarm: After the UPS is turned on in battery mode, press and hold this button for at least 3 seconds to disable or enable the alarm system. But it's not applied to the situations when warnings or errors occur. • Up key: Press this button to display previous selection in UPS setting mode. • Switch to UPS self-test mode: Press and hold ON/Mute button for 3 seconds to enter UPS self-testing while in AC mode
OFF/ENTER Button	<ul style="list-style-type: none"> • Turn off the UPS: Press and hold this button at least 2 seconds to turn off the UPS • Confirm selection key: Press this button to confirm selection in UPS setting mode.
SELECT Button	<ul style="list-style-type: none"> • Switch LCD message: Press this button to change the LCD message for input voltage, input frequency, battery voltage, output voltage and output frequency. • Setting mode: Press and hold this button for 3 seconds to enter UPS setting mode when UPS is off. • Down key: Press this button to display next selection in UPS setting mode.
Select + OFF/Enter Button	<ul style="list-style-type: none"> • Rack or Tower display switch: Press Select and OFF/Enter buttons simultaneously for 3 seconds. The display changes from/to Rack to/from Tower.

LCD Panel



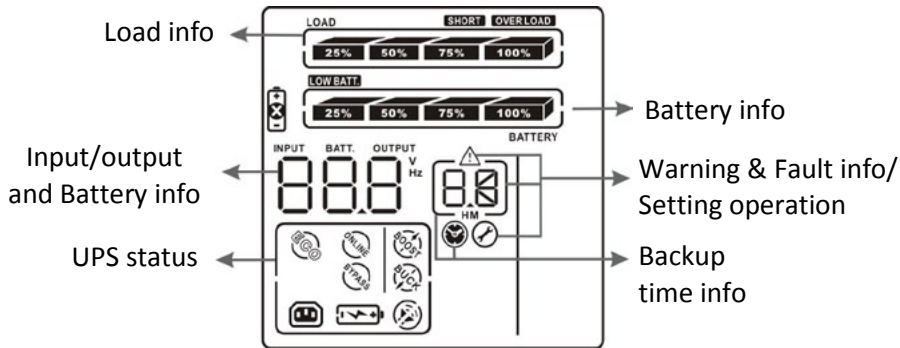



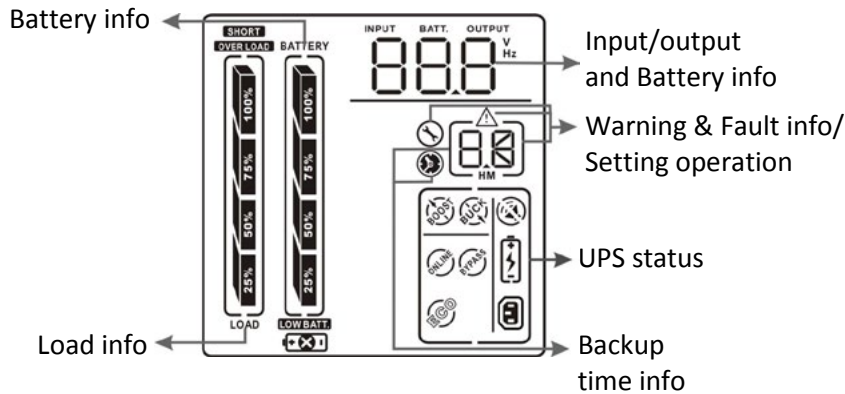





Rack Display



Tower Display



Display	Function
Backup Time Information	
	Indicates the backup time in pie chart.
	Indicates the backup time in numbers. H: hours, M: minutes
Warning & Fault Information	
	Indicates that the warning and fault occurs.
	Indicates the warning fault codes, which are listed in detail in this manual.
Setting Operation	
	Indicates the setting operation.
Input / Output & Battery Information	

	<p>Indicates the output/input voltage, output/input frequency or battery voltage. V: output voltage, Hz: frequency</p>
<p>Load Information</p>	
	<p>Indicates the load level by 0-25%, 26-50%, 51-75%, and 76-100%.</p>
	<p>Indicates overload.</p>
	<p>Indicates the load or the UPS output is short circuited.</p>
<p>UPS Status</p>	
	<p>Indicates that programmable management outlets are working.</p>
	<p>Indicates that the UPS alarm is disabled.</p>
	<p>Indicates the UPS powers the output directly from the mains</p>
	<p>Indicates the battery charger is working.</p>
	<p>Indicates the UPS is working in boost mode</p>
	<p>Indicates the UPS is working in buck mode</p>
<p>Battery Information</p>	
	<p>Indicates the Battery level by 0-25%, 26-50%, 51-75%, and 76-100%.</p>
	<p>Indicates low battery.</p>
	<p>Indicates there is something wrong with the battery.</p>

Audible Alarms

Description	Buzzer status
Battery Mode	Sounds every 10 seconds
Low Battery	Sounds every 2 seconds
Overload	Sounds every second
Fault	Continuously sounds

Abbreviations in LCD Display

Abbreviation	Display	Meaning
ENA	ENA	Enable
DIS	DIS	Disable
ESC	ESC	Escape
ON	ON	ON
OK	OK	OK
EP	EP	EPO
TP	TP	Temperature
CH	CH	Charger
RAC	RAC	Rack display
TOE	TOE	Tower display
SF	SF	Site Fault
EE	EE	EEPROM error
BR	BR	Battery Replacement

UPS Setting

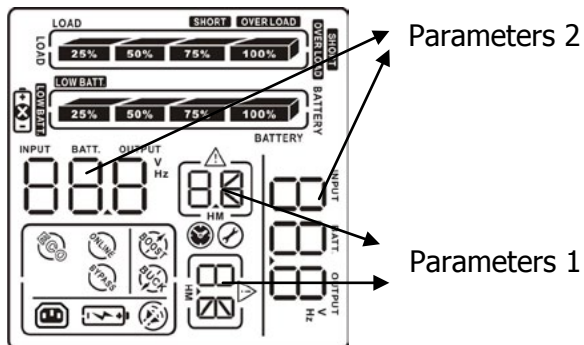

There are two parameters to set up the UPS. **Parameter 1:** For program alternatives. Refer to below table for details. **Parameter 2:** For setting options or values for each program.

01: Output Voltage Settings

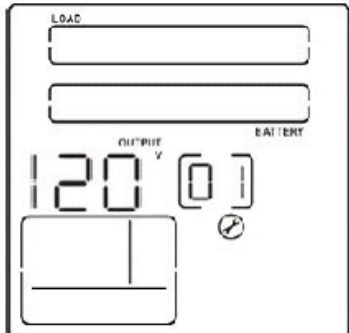
Interface	Setting
 <p>The diagram shows a control panel with two horizontal bars at the top labeled 'LOAD'. Below them is a digital display showing '120' with a 'V' symbol and '01' with a 'BATTERY' label. There are also some indicator lights and a small dial at the bottom.</p>	<p>You may choose the following output voltage:</p> <ul style="list-style-type: none"> 110: presents output voltage as 110VAC 115: presents output voltage as 115VAC 120: presents output voltage as 120VAC (Default) 127: presents output voltage as 127VAC

02: Programmable Outlets Enable/Disable

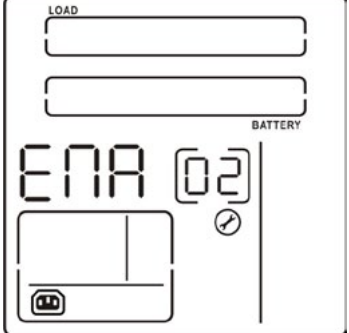
Interface	Setting
 <p>The diagram shows a control panel with two horizontal bars at the top labeled 'LOAD'. Below them is a digital display showing 'ENA' with a 'BATTERY' label and '02'. There are also some indicator lights and a small dial at the bottom.</p>	<ul style="list-style-type: none"> ENA: Programmable outlets enable (Default) DIS: Programmable outlets disable

03: Programmable Outlets Setting

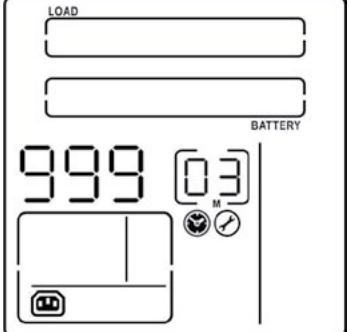
Interface	Setting
 <p>The diagram shows a control panel with two horizontal bars at the top labeled 'LOAD'. Below them is a digital display showing '999' with a 'BATTERY' label and '03'. There are also some indicator lights and a small dial at the bottom.</p>	<p>Setting the backup time limit in minutes from 0-999 for programmable outlets which connect to non-critical devices on battery mode.</p>

04: Maximum Charger Current Setting

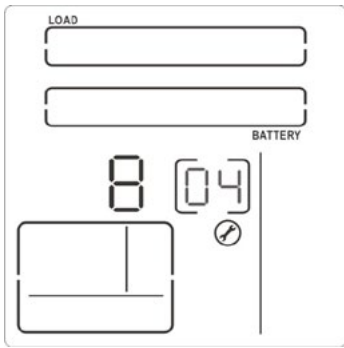
Interface	Setting
 <p>The LCD display shows two empty input fields at the top labeled 'LOAD' and 'BATTERY'. Below them, the number '8' is displayed on the left and '04' on the right. At the bottom, there is a battery level indicator and a power button icon.</p>	<p>Set up the maximum charger current. 1/2/4/6/8: Setting the maximum charger current at 1/2/4/6/8A (Default: 8A). Note: This setting is only effective for super charger.</p>

05: LCD Display Direction Setting

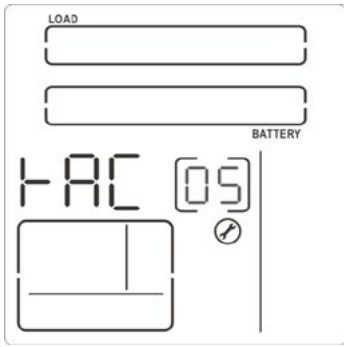
Interface	Setting
 <p>The LCD display shows two empty input fields at the top labeled 'LOAD' and 'BATTERY'. Below them, the text 'RAC' is displayed on the left and '05' on the right. At the bottom, there is a battery level indicator and a power button icon.</p>	<p>RAC: the LCD display is horizontal. TOE: the LCD display is vertical.</p>

06: Autonomy Limitation Setting

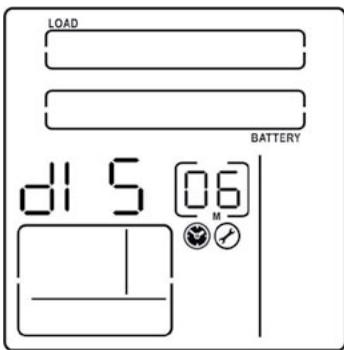

Interface	Setting
 <p>The LCD display shows two empty input fields at the top labeled 'LOAD' and 'BATTERY'. Below them, the text 'dl 5' is displayed on the left and '06' on the right. At the bottom, there is a battery level indicator and a power button icon.</p>	<p>Parameter 2: Set up backup time on battery mode for general outlets. 0-999: setting the backup time in minutes from 0-999 for general outlets on battery mode. DIS: Disable the autonomy limitation and the backup time will depend on battery capacity. (Default) Note: When setting is "0", the backup time will be only 10 seconds.</p>

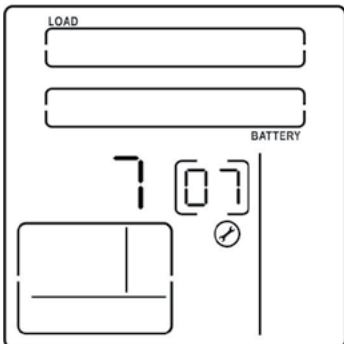
07: Battery Total AH Setting

Interface	Setting
	<p>Parameter 2: Set up the battery total AH of the UPS. 7-999: setting the battery total capacity from 7-999 in AH. Please set the correct battery total capacity if external battery bank is connected.</p>

00: Exit setting

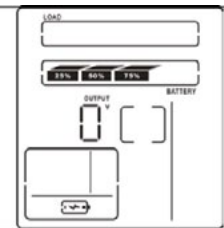
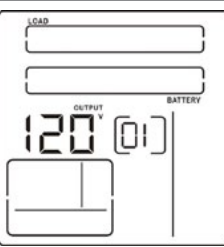
Steps for setting programmable outlet

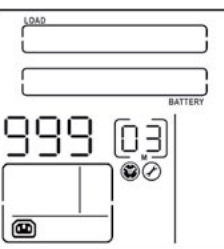
<p>Step 1: Before entering setting mode, the UPS should be in Stand-by mode (off-charging) and make sure the battery is connected. The LCD display is shown as right.</p>	
<p>Step 2: Press and hold the "Select" button for 3 seconds to enter Setting mode.</p>	
<p>Step 3: Press the "Up" button (ON/MUTE) to switch to "02" of program list. Then press "Enter" button to enter value setting of parameter 2. Press the "Up" button to change the value to "ENA" to enable the programmable outlet function. Then press "Enter" button again to confirm the setting.</p>	
<p>Step 4: Press the "Up" button (ON/MUTE) again to switch to "03" of program list. Then press "Enter" button for setting programmable outlet time. Push "Up" button to change the value of backup time desired. Then press "Enter" to confirm the setting.</p>	
<p>Step 5: Press "Up" button (ON/MUTE) to switch to "00" of program list. Then press "Enter" button to exit setting menu.</p>	
<p>Step 6: Disconnect AC input and wait until the LCD display is off. The new setting will be activated when turning on the UPS again.</p>	

Operating Mode Description

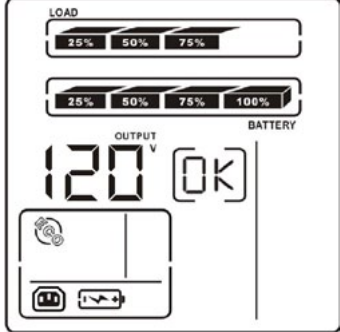
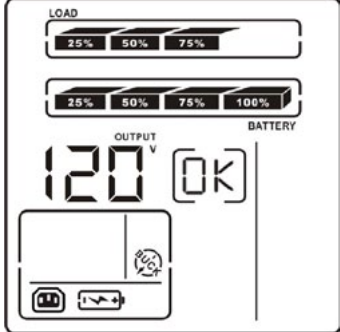
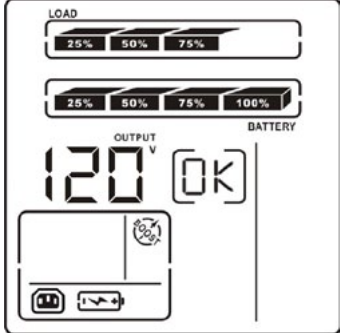
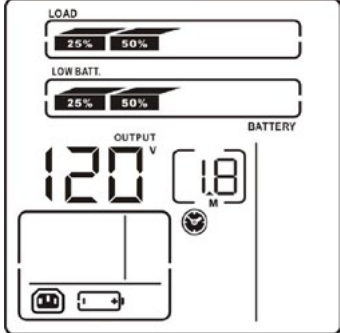

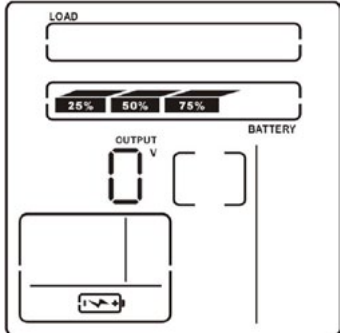





Operating Mode	Description	LCD Display
ECO mode	When the input voltage is within voltage regulated range, UPS will power the output directly from the mains. ECO is an abbreviation of Efficiency Corrective Optimizer. In this mode, when battery is fully charged, the fan will stop working for energy saving.	
Buck mode when AC is normal.	When the input voltage is higher than the voltage regulation range but lower than high loss point, the buck AVR will be activated.	
Boost mode when AC is normal.	When the input voltage is lower than the voltage regulation range but higher than low loss point, the boost AVR will be activated.	
Battery mode	When the input voltage is beyond the acceptable range or power failure and alarm is sounding every 10 seconds, UPS will backup power from battery.	



Standby mode	UPS is powered off without output power, but the battery is still being charged.	
--------------	--	---

Fault Reference Codes

Fault event	Fault code	Icon	Fault event	Fault code	Icon
Bus start failure	01	x	Inverter output short	14	SHORT
Bus over	02	x	Battery voltage too high	27	X
Bus under	03	x	Battery voltage too low	28	
Inverter soft start fail	11	x	Over temperature	41	X
Inverter voltage high	12	x	Overload	43	OVER LOAD
Inverter voltage Low	13	x	Charger failure	45	X







Warning Indicators

Warning	Icon (flashing)	Alarm
Low battery		Sounds every 2 seconds
Overload		Sounds every second
Battery not connected		Sounds every 2 seconds
Overcharge		Sounds every 2 seconds
Site wiring fault		Sounds every 2 seconds
EPO enable		Sounds every 2 seconds
Over temperature		Sounds every 2 seconds
Charger failure		Sounds every 2 seconds

Battery fault		Sounds every 2 seconds (At this time, UPS is off to remind users that something is wrong with the battery)
EEPROM error		Sounds every 2 seconds
Battery replacement		Sounds every 2 seconds

Troubleshooting

If the UPS does not operate correctly, please use the table below to troubleshoot the problems.

Symptom	Possible cause	Remedy
No indication and alarm even though the utility is normal.	The AC input power is not connected well.	Check that the input power cord is firmly connected to the utility.
	The AC input is connected to the UPS output.	Plug the AC input power cord into the AC input utility correctly.
The icon  and the warning code EP are flashing on LCD display and alarm is sounding every second.	EPO function is enabled.	Set the circuit to the closed position to disable EPO function.
The icon  and 5F are flashing on LCD display and alarm is sounding every second.	Line and neutral conductors of UPS input are reversed.	Have a qualified electrician correct the input receptacle wiring.
The icon  and  are flashing on LCD display and alarm is sounding every second	The internal battery is incorrectly connected.	Check to make sure all batteries are properly connected.
Fault code is shown as 27 and the icon  is showing on LCD display and alarm is continuously sounding.	Battery voltage is too high or the charger is in fault condition.	Contact your dealer for support.
Fault code is shown as 28 and the icon  is showing on LCD display and alarm is continuously sounding.	Battery voltage is too low or the charger is in fault condition.	Contact your dealer for support.
Fault code is shown as 14 and alarm is sounding continuously.	The UPS shut down automatically because short circuit condition occurred on the UPS output.	Disconnect loads and check output wiring or connected devices are in short circuit status.
Fault code is shown as 01, 02, 03, 04, 11, 12, 13 and 41 on LCD display and alarm is sounding continuously.	A UPS internal fault has occurred. There are two possible results: 1. The load is still supplied, but directly by AC utility via bypass. 2. The load is no longer supplied with power.	Contact your dealer for support.

Battery backup time is shorter than expected.	Batteries are not fully charged.	Charge the batteries for at least 5 hours and then re-check capacity. If the problem still exists, contact your dealer for support.
	Batteries are defective.	Contact your dealer for battery replacement.

Storage & Maintenance

Operation

The UPS system contains no user-serviceable parts. If the battery service life (3~5 years at 25°C ambient temperature) has been exceeded, the batteries must be replaced. In this case, please contact your dealer.



Be sure to deliver the spent battery to a recycling facility or ship it to your dealer in the replacement battery packing material.

Storage

Before storing, charge the UPS at least 5 hours. Store the UPS covered and upright in a cool, dry location. During storage, recharge the battery in accordance with the following table:

Storage Temperature	Recharge Frequency	Charging Duration
-25°C - 40°C	Every 3 months	1-2 hours
40°C - 45°C	Every 2 months	1-2 hours

Specifications

MODEL NUMBER		P80-800	P80-1100	P80-1500	P80-2200	P80-3000
CAPACITY	Power rating	800VA (720W)	1100VA (990W)	1500VA (1350W)	2000VA (2000W)	3000VA (2700W)
INPUT	Voltage nominal	120VAC				
	Voltage range	-32% to +27% without use of battery				
	Frequency	50/60Hz auto sensing				
OUTPUT	Voltage	120VAC nominal (110/115/127 selectable)				
	Waveform	Pure sine wave				
	Transfer time (typical)	2–6ms				
	Efficiency	Up to 99% ECO mode, 95% buck and boost mode				
	Harmonic distortion	2% @ 100% linear load; 5% @ 100% non-linear load				
BATTERY	Battery type	Sealed, maintenance-free lead acid				
	Battery quantity and size	(2) 12V 7AH	(2) 12V 9AH	(4) 12V 7AH	(6) 12V 7AH	(6) 12V 9AH
	Charging current	1.5A max				
	Typical recharge	4 hours to 90%				
PHYSICAL	Dimensions (W x D x H)	17.2 x 16.1 x 3.5 in		17.2 x 20.1 x 3.5 in	17.2 x 24.8 x 3.5 in	
	Weight	29.3 lbs	28.7 lbs	44.7 lbs	63.7 lbs	61.9 lbs
	Line cord	6 ft, 5–15P	6 ft, 5–15P	6 ft, 5–15P	6 ft, 5–20P	6 ft, L5–30P
	Receptacles	(8) NEMA 5–15R			(8) NEMA 5–15/20R	
OPTIONAL BATTERY PACKS	Model number	N/A		BP48	BP72	
	Dimensions (W x D x H)	N/A		17.2 x 18.9 x 3.5 in	17.2 x 23.6 x 3.5 in	
	Weight	N/A		74.6 lbs	104.4 lbs	
	Battery	N/A		(8) 12V 9AH / 48V	(12) 12V 9AH / 72V	
ENVIRONMENT	Operating temperature	32–104°F (0–40°C)				
	Audible noise	< 45dBA				
	Altitude	11,500 ft above sea level				
APPROVALS	UL, cUL, RoHS					
WARRANTY	3 years electronics, 3 years battery warranty (USA and Canada)					
COMMUNICATIONS INTERFACE	RS-232, USB, EPO, intelligent slot for optional cards (Web/SNMP, Relay/dry contact, Modbus)					
INCLUDED IN BOX	Software CD, horizontal brackets, tower pedestals, user manual					
AVAILABLE OPTIONS	5 year extended warranty, bypass distribution (XBDM), power distribution (XPDU), 4-post rail kit, 2-post shelf kit, wall mount bracket					

Obtaining Service

If the UPS requires Service:

1. Use the TROUBLESHOOTING section in this manual to eliminate obvious causes.
2. Verify there are no circuit breakers tripped.
3. Call your dealer for assistance. If you cannot reach your dealer, or if they cannot resolve the problem, call Xtreme Power Conversion Corp Technical Support at 800.582.4524. Technical support inquiries can also be made at support@xpcc.com. Please have the following information available BEFORE calling the Technical Support Department:
 - Your name and address.
 - The serial number of the unit.
 - Where and when the unit was purchased.
 - All of the model information about your UPS.
 - Any information on the failure, including LED's that may or may not be illuminated.
 - A description of the protected equipment, including model numbers if possible.
 - A technician will ask you for the above information and, if possible, help solve your problem over the phone. In the event that the unit requires factory service, the technician will issue you a Return Material Authorization number (RMA).

If you are returning the UPS to Xtreme Power for service, please follow these procedures:

1. Pack the UPS in its original packaging. If the original packaging is no longer available, ask the Technical Support Technician about obtaining a replacement set of packaging material. It is important to pack the UPS properly in order to avoid damage in transit. Never use Styrofoam beads for a packing material.
2. Include a letter with your name, address, daytime phone number, RMA number, a copy of your original sales receipt, and a brief description of the problem.
3. Mark the RMA number on the outside of all packages. Xtreme Power cannot accept any package without the RMA number marked on the outside of the boxes.
4. Return the UPS by insured, prepaid carrier to the address provided by the Technician.
5. Refer to the Warranty statements in this manual for additional details on what is covered.

Xtreme Power Conversion Limited Warranty

Xtreme Power Conversion (XPC) Corporation warrants Xtreme Power Conversion equipment, when properly applied and operated within specified conditions, against faulty materials or workmanship for a period of **three years for P80-Series products** from the date of purchase. XPC Corporation warrants **internal batteries for a period of three years** from the date of purchase. For equipment sites within the United States and Canada, this warranty covers repair or replacement, at the sole discretion of XPC Corporation. The customer is responsible for the costs of shipping the defective product to XPC Corporation. XPC Corporation will pay for ground shipment of the repaired or replacement product. This warranty applies only to the original purchaser.

If equipment provided by XPC Corporation is found to be **Dead-on-Arrival (DOA)**, XPC Corporation will be responsible for the costs of shipping product to and returning equipment from the customer in a timely manner as agreed to with the customer, once the customer has requested and received a **Return Material Authorization (RMA)** number. DOA equipment is defined as equipment that does not properly function according to user documentation when initially received and connected in conjunction with proper procedures as shown in the user documentation or via support provided by XPC Corporation personnel or authorized agents.

This warranty shall be void if (a) the equipment is repaired or modified by anyone other than XPC Corporation or a XPC Corporation approved third party; (b) the equipment is damaged by the customer, is improperly used or stored, is subjected to an adverse operating environment, or is operated outside the limits of its electrical specifications; or (c) the equipment has been used or stored in a manner contrary to the equipment's operating manual, intended use or other written instructions. Any technical advice furnished by XPC Corporation or a XPC Corporation authorized representative before or after delivery with regard to the use or application of Xtreme Power Conversion equipment is furnished on the basis that it represents XPC Corporations best judgment under the situation and circumstances, but it is used at the recipient's sole risk.

EXCEPT AS STATED ABOVE, XPC Corporation DISCLAIMS ALL WARRANTIES, EXPRESSED OR IMPLIED, INCLUDING WARRANTIES OF MERCHANTABILITY AND FITNESS FOR A PARTICULAR PURPOSE.

EXCEPT AS STATED ABOVE, IN NO EVENT WILL XPC Corporation BE LIABLE FOR DIRECT, INDIRECT, SPECIAL, INCIDENTAL, OR CONSEQUENTIAL DAMAGES ARISING OUT OF THE USE OF Xtreme Power Conversion EQUIPMENT, including but not limited to, any costs, lost profits or revenue, loss of equipment, loss of use of equipment, loss of software, loss of data, cost of substitutes, or claims by third parties. Purchaser's sole and exclusive remedy for breach of any warranty, expressed or implied, concerning Xtreme Power Conversion equipment, and the only obligation of XPC Corporation under this warranty, shall be the repair or replacement of defective equipment, components, or parts; or, at XPC Corporations sole discretion, refund of the purchase price or substitution of an equivalent replacement product.

Xtreme Power Conversion Load Protection Policy

THIS POLICY IS NOT A WARRANTY. REFER TO **THE XPC CORPORATION, INC. LIMITED WARRANTY** FOR INFORMATION CONCERNING THE WARRANTY FOR YOUR XPC PRODUCT. THE LIMITATIONS AND CONDITIONS CONTAINED IN THIS POLICY DO NOT AFFECT **THE TERMS OF THE XPC LIMITED WARRANTY**.

Definitions:

1. "Product" means a Standard 120, 208, or 240 Volt power protection device that is used in the United States and Canada. This policy does not include custom manufactured products.
2. "Power Disturbance" means an AC power line transient (telephone line or Local Area Network, if applicable), spike or surge.
3. "Connected Equipment" properly connected electronic equipment
4. "Fair Market Value" of damaged Connected Equipment as determined by XPC shall be the lower of (a) the average price the same or similar items are being sold for on eBay, (b) the price list of Orion Blue Book (or if such price list is no longer published, a published or announced price list reasonably selected by XPC), (c) the lowest price the same or similar items can be purchased for in the United States or (d) the total amount of all payment(s) you have or are entitled to receive from insurance, other warranties, extended warranties, a legal liability claim or from other sources or persons for the damaged Connected Equipment.
5. "Purchaser" means the person or entity that originally purchased the Product from an authorized reseller or distributor of XPC Products.

The Purchaser of this Product is protected, for the term of the XPC Limited Warranty, against certain losses caused by a Power Disturbance for properly connected electronic equipment (referred to as the "Connected Equipment") subject to certain terms and conditions provided below.

This policy applies only to the original purchaser of the Product. If the Product is transferred or sold to another person or entity, this policy is void.

Load Protection Policy Dollar and Period Limits

For purchasers that meet the qualifications and conditions set forth in this policy, XPC will provide reimbursement (cost of repair or fair market value as determined by XPC) during the period limits and up to the dollar limits stated as follows:

PRODUCT	DOLLAR LIMIT	PERIOD OF COVERAGE
XVT	25,000	Term of XPC Limited Warranty
XST	25,000	Term of XPC Limited Warranty
S70	25,000	Term of XPC Limited Warranty
P80, P80g	50,000	Term of XPC Limited Warranty
XPRT 6kVA & 10kVA	50,000	Term of XPC Limited Warranty
NXRT	50,000	Term of XPC Limited Warranty
P90, P90L, P90g, P90Lg	50,000	Term of XPC Limited Warranty
T90	50,000	Term of XPC Limited Warranty
TX90, TX90i	50,000	Term of XPC Limited Warranty

This Load Protection Policy is not deemed "first dollar" coverage. XPC's obligation is reduced by any amounts that the Purchaser is entitled to recover, from other sources regarding the Connected Equipment, including, but not limited to, insurance, other warranty, extended warranty, or legal liability, regardless of whether or not the Purchaser makes a claim for recovery.

Eligibility for Coverage Under the Load Protection Policy

1. The Product must be registered on the XPC website, www.xpcc.com, within 10 days of purchase. All required information must be provided, and Purchaser should retain a copy for Purchaser's records. When

registering on the website, Purchaser must list all connected equipment that is directly connected to the product. Only those devices registered in that manner will be covered.

2. All Connected Equipment must be UL or CSA approved.
3. The Product must be plugged into a properly wired and grounded outlet. Use of input surge devices, extension cords, adapters, ground wires, or electrical connections not manufactured by XPC voids the XPC Load Protection Policy. No other surge protection device may be connected to the output sockets of the Product. The installation must comply with all applicable electrical and safety codes set forth pursuant to the NEC.
4. The Product must have undeniable physical evidence of a Power Disturbance that directly and proximately caused the damage;
5. The Connected Equipment must have been damaged by a Power Disturbance on a properly installed, grounded, and National Electric Code, ("NEC"), code-compliant 120, 208, 240 Volt AC power line in the United States or Canada, by a Power Disturbance on standard telephone land line or PBX telephone equipment line that is properly installed and connected to an RJ11 port on the Product; or by a Power Disturbance on a standard Local Area Network connection that is properly installed and connected to an RJ45 port on the Product and (d) is directly plugged into, and properly connected to, the Product in its original condition which was properly operated when a Power Disturbance passed through the Product and (i) exhausts the protection capacity of the Product or (ii) damages the Product.
6. The Load Protection Policy does not apply if the Product has been operated in a failure mode or not in compliance with XPC operating instructions in the Product user's manual, or if the Connected Equipment has not been operated in compliance with the instructions and manuals of its manufacturer/vendor.
7. This policy is null and void if, XPC determines, in its sole discretion, that the Product has been tampered with or altered in any way.

What is Not Covered Under the Load Protection Policy:

The following damage is not covered by this Policy:

1. Restoration of lost data and reinstallation of software.
2. Damage from a cause other than AC power-line transients, except for damage due to telephone line, Local Area Network, or CATV transients, which is covered only if the Product offers such protection.
3. DAMAGE CAUSED BY FAILURE TO PROVIDE A SUITABLE INSTALLATION ENVIRONMENT FOR THE PRODUCT (INCLUDING, BUT NOT LIMITED TO, LACK OF A PROPER SAFETY GROUND).
4. Damage caused by the use of the Product for purposes other than those for which it was designed.
5. Damage caused by accidents, or natural disasters, including but not limited to, fire, flood, and wind.
6. Damage caused by abuse, misuse, alteration, modification, or negligence.
7. Any labor costs or travel, room and board expenses associated with the repair and/or restoration of lost or damaged hardware, software or data.

EXCEPT AS EXPRESSLY PROVIDED IN THIS POLICY, XPC SHALL NOT BE LIABLE FOR ANY DAMAGES WHATSOEVER, INCLUDING, BUT NOT LIMITED TO, DIRECT, INDIRECT, SPECIAL, INCIDENTAL, CONSEQUENTIAL, OR MULTIPLE DAMAGES ARISING OUT OF THE USE OF THE PRODUCT OR DAMAGE TO THE CONNECTED EQUIPMENT, REGARDLESS OF THE LEGAL THEORY ON WHICH SUCH CLAIM IS BASED, EVEN IF ADVISED OF THE POSSIBILITY OF SUCH DAMAGE. SUCH DAMAGES INCLUDE, BUT ARE NOT LIMITED TO, LOSS OF PROFITS, LOSS OF SAVINGS OR REVENUE, LOSS OF USE OF THE PRODUCT OR THE CONNECTED EQUIPMENT OR ANY ASSOCIATED EQUIPMENT, LOSS OF SOFTWARE, COST OF CAPITAL, COST OF ANY SUBSTITUTE EQUIPMENT, FACILITIES OR SERVICES, DOWNTIME, THE CLAIMS OF THIRD PARTIES, INCLUDING CUSTOMERS, AND INJURY TO PROPERTY.

Submitting a Load Protection Policy Claim:

1. Any claim under the Load Protection Policy must be made within 10 days of the date of alleged damage to the Connected Equipment.
2. Call the XPC technical support department at 1-800- 582-4524 and obtain a Load Protection Policy Returned Material Authorization (RMA) number. Have information on all applicable insurance or other resources of recovery/payment that is available to the Purchaser and the name of the power utility supplier for the location

of the Connected Equipment. XPC will forward to the Purchaser a Load Protection Policy claims form, which must be completed and filed with XPC within 30 days.

- Mark the Load Protection Policy RMA number on the Product the Purchaser is returning.
- Pack the Product in its original packaging or similar packing materials if the original packaging has been discarded. Enclose the completed Load Protection Policy claim form and a copy of the Purchaser's original sales receipt for the Product in the box.
- Mark the RMA number clearly on the outside of the box.
- Ship the Product (one-way shipping charges paid by the Purchaser) to:

XPC Corporation
230 Yuma Street
Denver, CO 80223
Attn: LPP RMA#

3. XPC will evaluate the Product to determine its level of functionality, and will examine the Product for evidence of damage from a Power Disturbance.
 - If XPCs' evaluation provides no evidence of damage from a Power Disturbance, XPC will send to the Purchaser (i) a report summarizing the tests performed and (ii) a rejection of claim notice.
 - If the Product shows evidence of damage from a Power Disturbance, XPC will request that all Connected Equipment for which a Load Protection Policy claim has been submitted, be sent for evaluation to either XPC or an authorized service center. If it is determined that the Connected Equipment has been damaged by a Power Disturbance, XPC will, in its sole discretion, issue payment to the Purchaser for either the cost of repair of the Connected Equipment or the Fair Market Value of the damaged Connected Equipment, up to the dollar limits stated above. XPC reserves the right to require the Purchaser to transfer title and deliver the Connected Equipment to XPC if it chooses to reimburse the Purchaser for the fair market value of the Connected Equipment. XPCs' maximum liability shall be reduced to reflect all such other payments or sources of recovery, whether applied for or not.
4. If XPC issues payment to the Purchaser to have the Connected Equipment repaired, the repair must be performed at a service center that is authorized by the manufacturer of the Connected Equipment. XPC reserves the right to contact the authorized service center directly to discuss repair costs and damage to the Connected Equipment to determine if it was caused by a Power Disturbance and the right to request that the service center forward the Connected Equipment or components of the Connected Equipment to XPC for inspection
5. Unless modified in writing signed by an officer of XPC and the Purchaser, the terms of this policy are the complete and exclusive agreement between the parties, superseding all prior agreements, oral or written, and all other communications between the parties relating to the subject matter of this agreement. No employee of XPC or any other party is authorized to make any representations beyond those made in this agreement concerning the Load Protection Policy.

XPC Corporation
230 Yuma Street
Denver, CO 80223
1.800.582.4524

Appendix A: P90-BP48 & P90-BP72 User Guide

Important Safety Instructions

Please comply with all warnings and operating instructions in this manual strictly. Save this manual properly and read carefully the following instructions before installing the unit. Do not operate this unit before reading through all safety information and operating instructions carefully.

- Do not try to repair the unit yourself, contact your local supplier or your warranty will be void.
- To eliminate any overheating of the battery box, keep all ventilation openings free from obstruction and do not place any foreign objects on top of the battery bank. Keep the battery box 20cm away from the wall.
- Make sure the battery box is installed within the proper environment as specified. (0-40°C and 30-90% non-condensing humidity)
- Do not install the battery box under direct sunlight. Your warranty will be void if the batteries fail due to overheating.
- This battery box is not designed for use in dusty, corrosive and salty environment.
- The warranty for this battery bank will be void if water or other liquid is spilled or poured directly onto the battery box. Similarly we do not warrant any damage to the battery box if foreign objects are deliberately or accidentally inserted into the battery box enclosure.
- The battery will discharge naturally if the system is unused for a period of time.
- It should be recharged every 2-3 months if unused. If this is not done, then the warranty will be null and void. During normal operation, the batteries will automatically remain in charged condition.
- Servicing of batteries should be performed or supervised by trained personnel with knowledge of batteries and the required precautions.
- When replacing batteries, it is necessary to replace ALL batteries with the same quantity, type & capacity.
- CAUTION – Do not dispose of battery or batteries in a fire. The battery may explode.
- CAUTION – Do not open or mutilate the batteries. The electrolyte from the batteries is toxic and harmful to the skin and eyes.
- CAUTION – Risk of Electric Shock –Hazardous voltage may exist between battery terminals and ground. Test before touching with bare hands.
- CAUTION – A battery can present a risk of electrical shock and high short circuit current. The following precaution should be observed when working on batteries:
 1. Remove watches, rings, or other metal objects.
 2. Use tools with insulated handles.
 3. Wear rubber gloves and boots.
 4. Do not lay tools or metal parts on top of batteries.
 5. Disconnect charging source prior to connecting or disconnecting battery terminals.
- Do not plug or unplug the battery connector if UPS works in DC (discharging) mode.

Product Overview and Setup

NOTE: Before installation, please inspect the unit. Be sure that nothing inside the package is damaged. Please keep the original package in a safe place for future use.

Rear Panel View

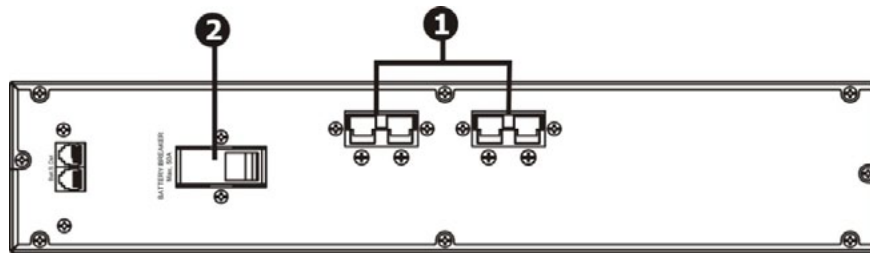

1. DC connector : connects to either UPS or 2nd battery box
2. DC breaker: Battery over-current protection breaker

Installation and Setup with UPS

Unpacking & Inspection

1. Remove the battery box from the packing.

Note: The battery box is very heavy, be cautious when unpacking and lifting the unit to avoid injury.

2. Check the inside package
 - Battery box unit
 - Manual
 - Battery connection cable x 1
 - Ear x 2 & screw x 8
 - Extended stand

Selecting Installation Position

It is necessary to select a proper environment to install the unit, in order to minimize the possibility of damage to the battery box and extend the life of the batteries. Please follow the instructions below:

1. Keep at least 20cm (8 inches) clearance from the rear panel of the unit from the wall or other obstructions.
2. Do not block the air-flow to the ventilation openings of the unit.
3. Please ensure the installation site environmental conditions are in accordance with the unit's working specifications to avoid overheat and excessive moisture.
4. Do not place the unit in a dusty or corrosive environment or near any flammable objects.
5. This unit is not designed for outdoor use.

This unit can either be rack mounted or placed vertically on the desk.

Rack Installation

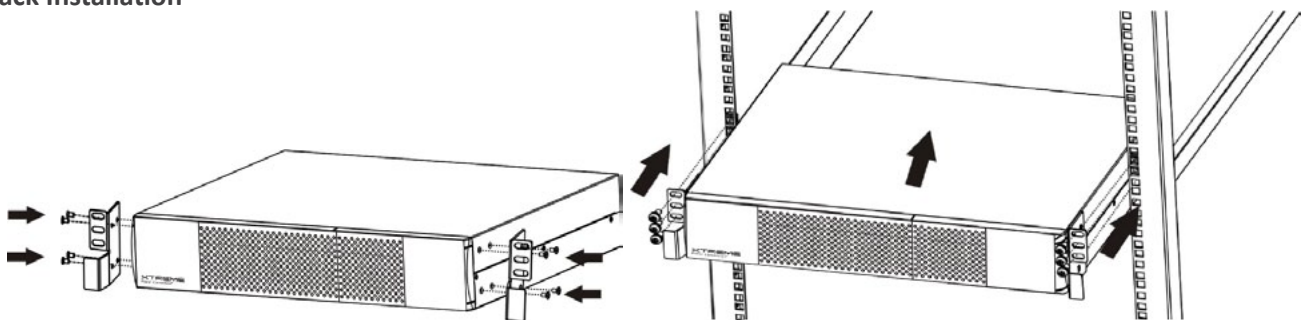

Tower Installation

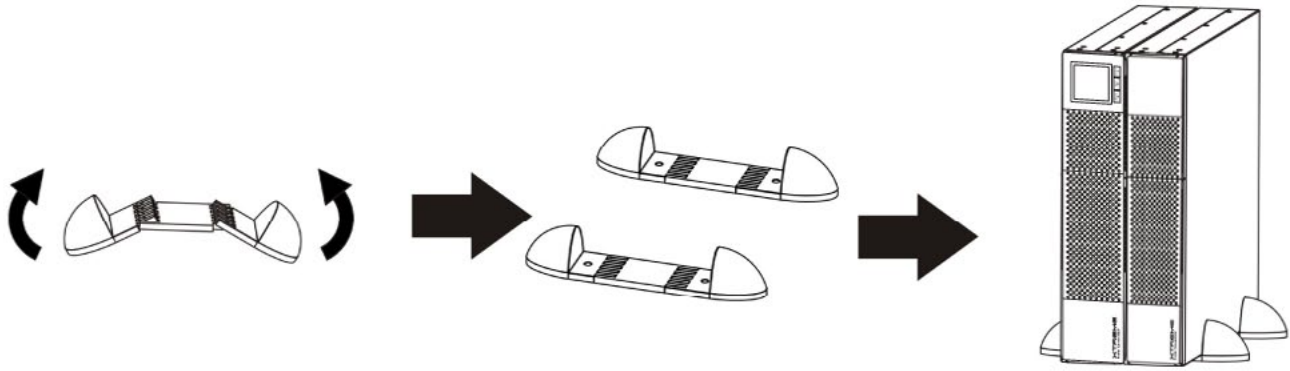

Connecting with UPS and Other Battery Box

Follow below installation chart to connect with UPS and other battery box with included cable.

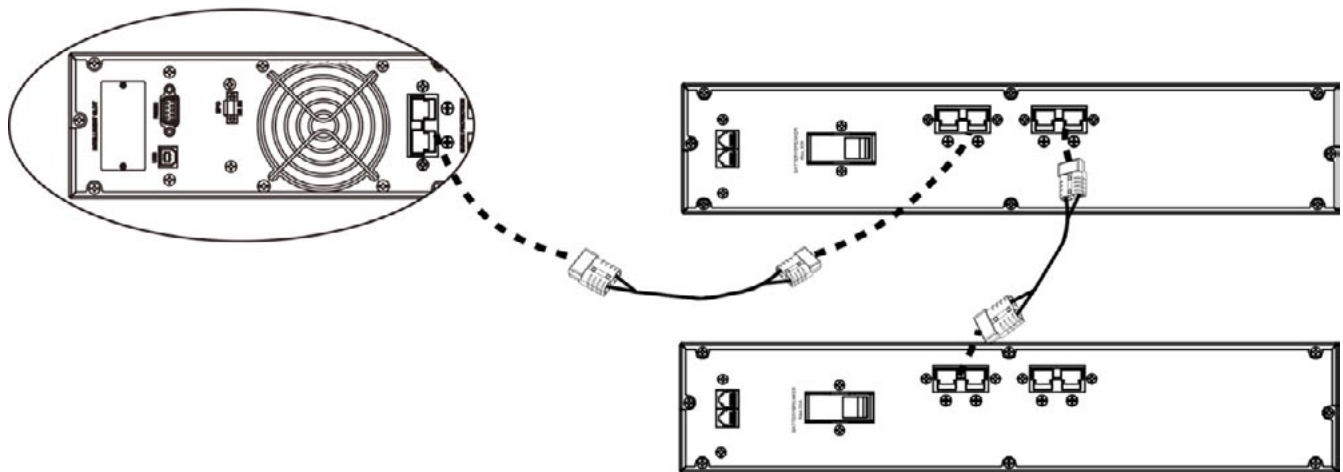

Type of Battery Required

This battery box has been designed to operate with the following types of batteries:

48V/9Ah Version: 4 pieces of 12V 9Ah batteries per string

72V/9Ah Version: 6 pieces of 12V 9Ah batteries per string

Battery Replacement

If your battery box is not installed with batteries, please follow proper procedure to put batteries inside of unit.

NOTE: MAKE SURE THAT THE BATTERY BOX IS DISCONNECTED FROM THE UPS BEFORE PERFORMING THE FOLLOWING SEQUENCE OF OPERATIONS.

P90-BP48

Step 1 : Open the package and place the battery box on a horizontal plane.

Step 2: Remove the removable front panel part by pulling it from the lower extremity

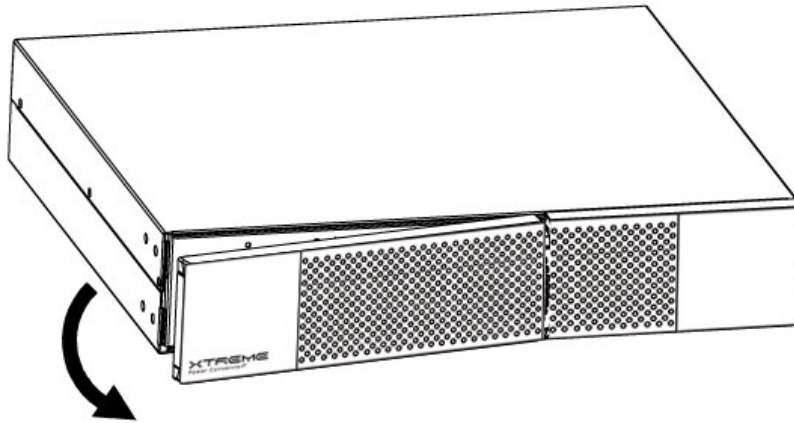

Step 3: Remove the fixed part of the front panel by removing the 2 screw present.

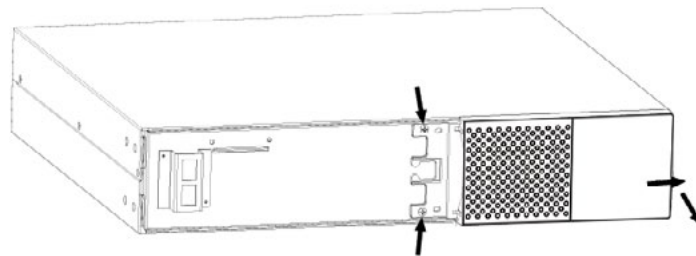

Step 4: Remove the metal top cover of the battery box by unscrewing 8 screws present on the two sides (4 on the right side and 4 on the left side), 3 screws on the top and 4 screws on the back side.

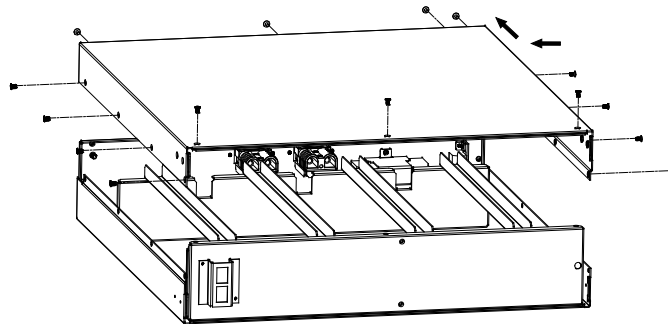

Step 5: Once the battery box is opened, remove the battery hold down brackets present on the left side of the battery box by unscrewing the 2 screws on each bracket.

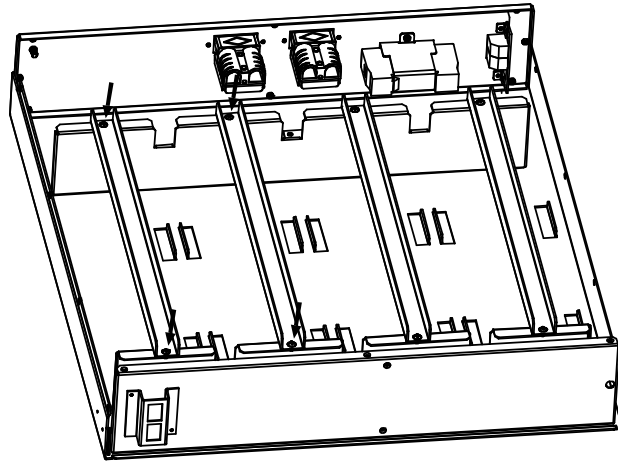

Note: To install the second string of batteries, repeat the same procedure on the battery hold down brackets on the right side of the battery box.

Step 6: Now, it is possible to put all batteries inside the unit by following the below picture (the following drawing are indicates the wire fastener positions for the correct battery placement).

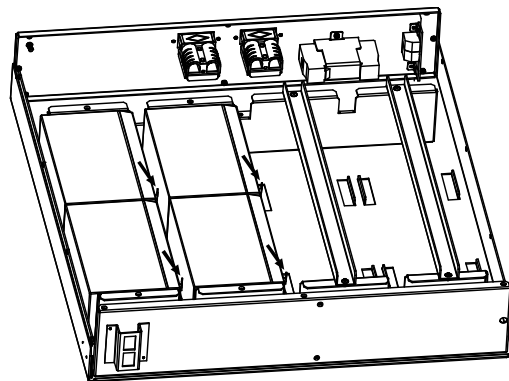

Note: To install the second string of batteries, repeat the same procedure on the right side of battery box.

Step 7: Connect all batteries following the wiring diagram shown in next chapter.

Step 8: Put all batteries inside and secure in place with hold down brackets.

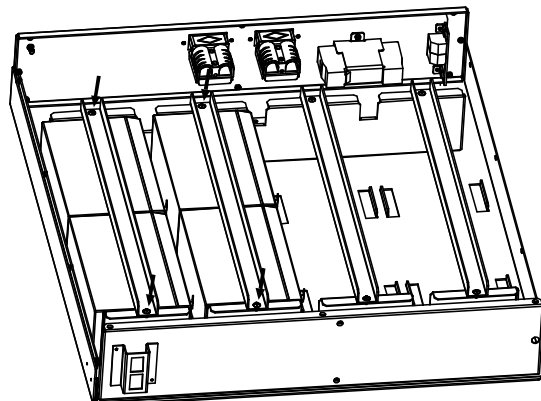

Note: To install the second string of batteries, repeat the same procedure on the right side of battery box.

Step 9: Put the metal top cover back on the unit. Close the front fixing plate and the two parts of the front panel and secure it with screws.

Step 10: Connect the battery box to the UPS.

P90-BP72

Step 1 : Open the package and place the battery box on a horizontal plane.

Step 2: Remove the removable front panel part by pulling it from the lower extremity

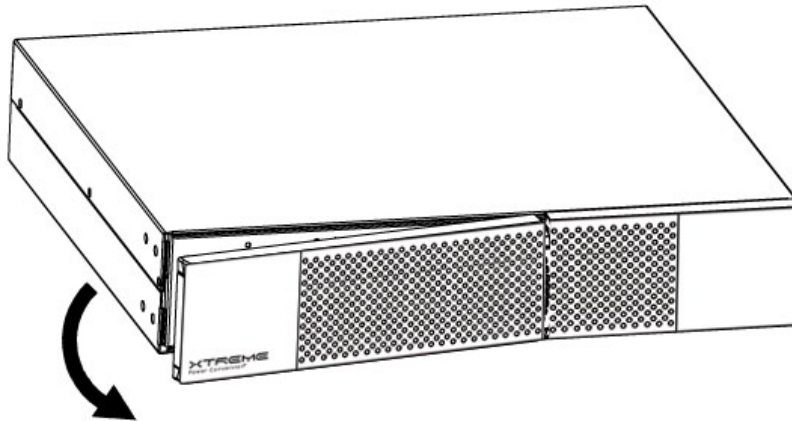

Step 3: Remove the fixed part of the front panel by removing 2 screw present.

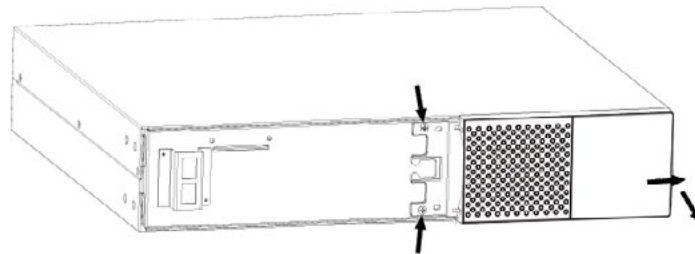

Step 4: Remove the metal top cover of the battery box by unscrewing 8 screws present on the two sides (4 on the right side and 4 on the left side), 3 screws on the top and 4 screws on the back side.

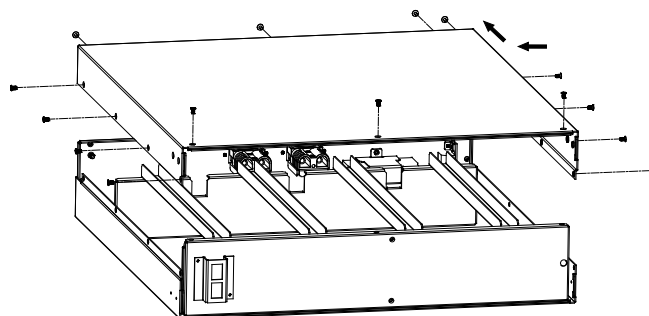

Step 5: Once battery box is opened, remove the battery hold down brackets present on the left side of the battery box by unscrewing the 2 screws on each bracket.

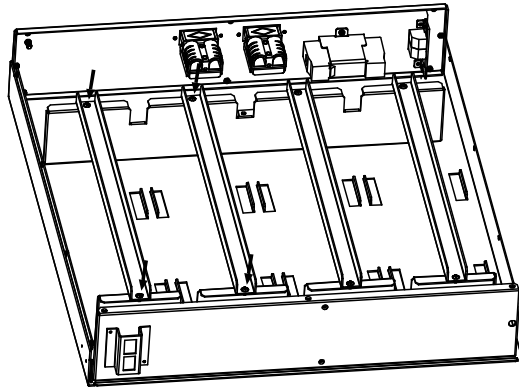

Note: To install the second branch of batteries, repeat the same procedure on the battery fixing plate on the right side of battery box.

Step 6: Now, it is possible to put the batteries inside following below picture (in the following drawing are indicated the fasten positions for the correct batteries placing).

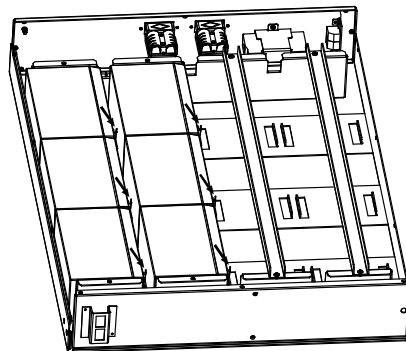

Note: To install the second string of batteries, repeat the same procedure on the right side of battery box.

Step 7: Connect all batteries following the wiring diagram shown in next chapter.

Step 8: Put all batteries inside and secure in place with the hold down brackets.

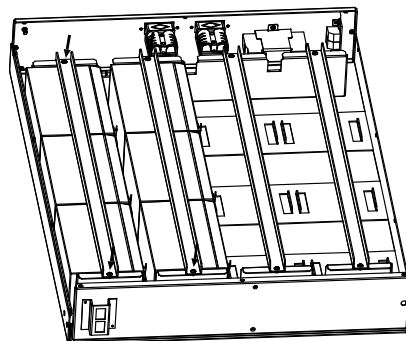

Note: To install the second string of batteries, repeat the same procedure on the right side of battery box.

Step 9: Put the metal top cover back on the unit. Close the front fixing plate and the two parts of the front panel and secure it with screws.

Step 10: Connect the battery box to the UPS.

Wiring Diagram

P90-BP48

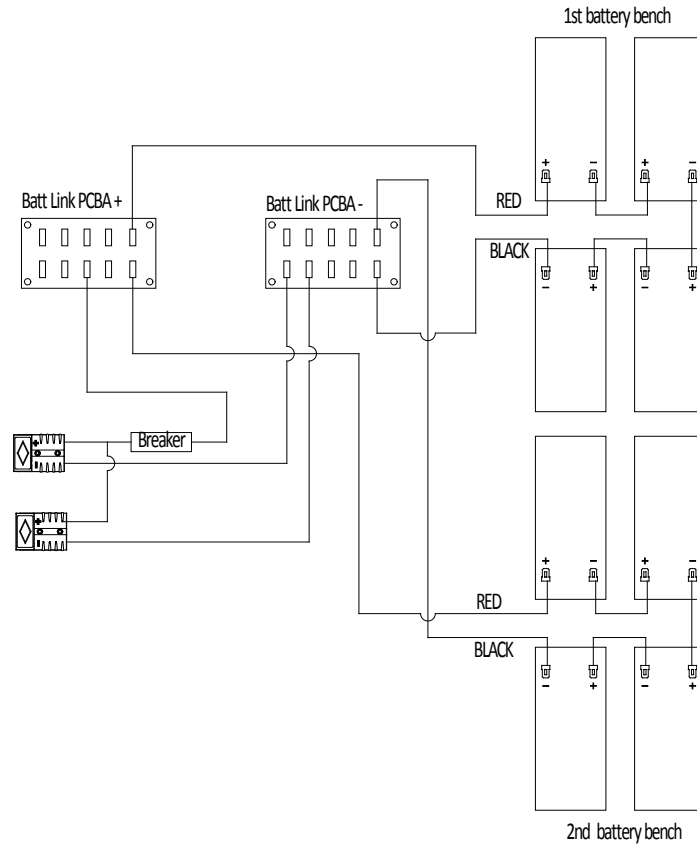

Picture example as below:

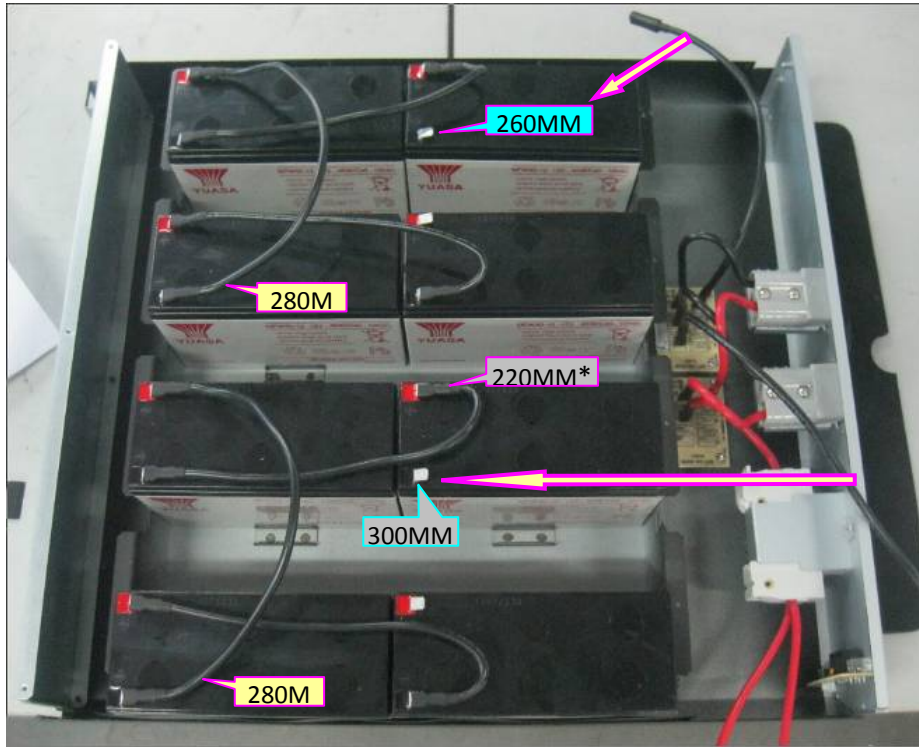

Note: The cable connection from the external battery connector to PCB is already present inside the battery box. All the other cable connections should be made in accordance with the above wiring diagram.

P90-BP72

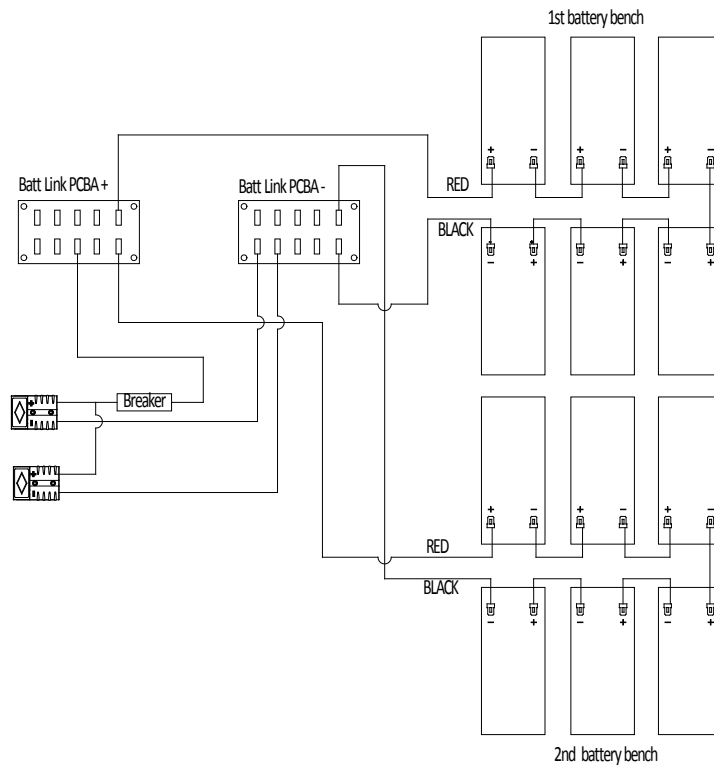

Picture example as below:

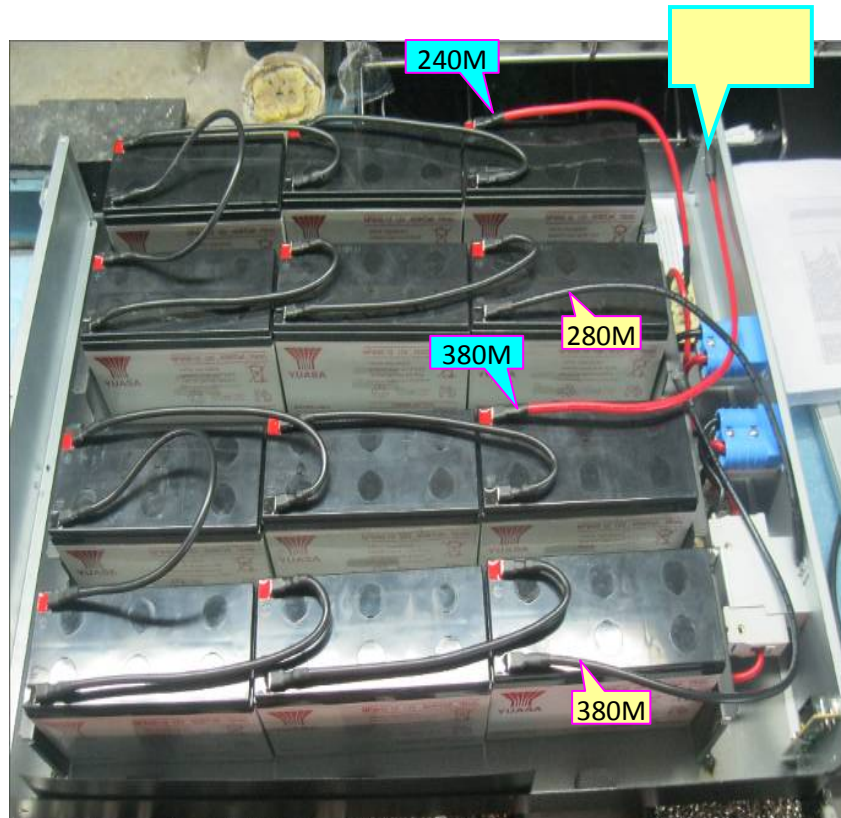

Note: The cable connection from the external battery connector to PCB is already present inside the battery box. All the other cable connections should be made in accordance with the above wiring diagram.

Storage & Maintenance

The unit contains no user-serviceable parts. If the battery service life (3~5 years at 25°C ambient temperature) has been exceeded, the batteries must be replaced. In this case, please contact your dealer.

Be sure to deliver the spent battery to a recycling facility or ship it to your dealer in the replacement battery packing material.

Storage

Before storing, charge the unit 4 hours. Store the unit covered and upright in a cool, dry location. During storage, recharge the battery in accordance with the following table:

Storage Temperature	Recharge Frequency	Charging Duration
-25°C - 40°C	Every 3 months	1-2 hours
40°C - 45°C	Every 2 months	1-2 hours