



NXRi Online UPS

6kVA, 10kVA Models

User & Installation Manual

Table of Contents

Standards.....	5
Safety.....	5
EMI.....	5
EMS.....	6
Introduction.....	6
Product Description.....	6
Double Conversion On-Line Technology.....	6
Diagnostic Tests.....	7
System Configuration.....	7
LED & LCD Descriptions.....	10
RS-232 Standard Interface.....	11
SNMP Communications Option.....	11
Remote Emergency Power Off (REPO) Port.....	11
Hardware Installation Guide.....	11
Safety Information.....	11
Storage and Transportation.....	11
Environment.....	12
Rack-Mount Installation (Using 4-Post Rail Kit).....	12
UPS Installation.....	15
UPS Installation for Parallel Systems.....	16
Battery Pack Installation.....	17
Software Installation.....	17
Operations.....	18
Button Operation.....	18
LED Indicators and LCD Panel.....	18
Parallel Operation.....	24
LCD Parameter Settings.....	26
Operating Mode / Status Description.....	31

Fault Code.....33

Warning Indicator.....33

Troubleshooting.....34

Storage and Maintenance.....36

Storage.....36

Maintenance.....36

Batteries.....37

Replacing the Battery.....37

Specifications.....38

Battery Runtimes.....38

Shipping List (UPS).....39

Shipping List (EBP20).....39

Obtaining Service.....40

Thank you for selecting this uninterruptible power supply (UPS). It provides you with protection for connected equipment. **Please read this manual** before installing the NXRi-Series UPS models NXRi-6k and NXRi-10k as it provides important information that should be followed during installation and maintenance of the UPS and batteries, allowing you to correctly set up your system for the maximum safety and performance. Included is information on customer support and service, if it is required. If you experience a problem with the UPS, please refer to the Troubleshooting section in this manual to correct the problem. If the problem is not corrected, please collect information so that the Technical Support personnel can more effectively assist you.

IMPORTANT SAFETY INSTRUCTIONS: (SAVE THESE INSTRUCTIONS)

CAUTION! (UPS having Internal Batteries): Risk of electrical shock – Hazardous live parts inside this unit are energized from the battery supply even when the input AC power is disconnected.

CAUTION! (No User serviceable Parts): Risk of electrical shock, do not remove cover. No user serviceable parts inside. Refer servicing to qualified service personnel.

CAUTION! (Non-isolated Battery supply): Risk of electric shock, battery circuit is not isolated from AC input, hazardous voltage may exist between battery terminals and ground. Test before touching.

WARNING! (Fuses): To reduce the risk of fire, replace only with the same type and size of fuse.

WARNING! Unit intended for installation in a controlled environment.

CAUTION! Do not dispose of batteries in a fire, the battery may explode.

CAUTION! Do not open or mutilate the battery, released electrolyte is harmful to the skin and eyes.

CAUTION! A battery can present a risk of electric shock and high short circuit current. The following precaution should be observed when working on batteries:

- Remove watches, rings or other metal objects.
- Use tools with insulated handles.

To reduce the risk of electric shock, disconnect the UPS from the main supply before installing a computer interface signal cable. Reconnect the power cord only after signaling interconnections have been made.

Servicing of batteries should be performed or supervised by personnel with knowledge of batteries and the required precautions. Keep unauthorized personnel away from batteries.

These UPS units are extremely heavy. Do not install the UPS in a rack or enclosure by its front two ears only. Adjustable rack rails are required for this type of installation.

The instructions contained within this safety manual are deemed important and should be closely followed at all times during installation and follow-up maintenance of the UPS and batteries.

**CAUTION**

The unit has a dangerous amount of voltage. If the UPS indicator is on, the unit's outlets may have a dangerous amount of voltage even when not plugged into the wall outlet because the battery may continue to supply power.

Care should be taken to undertake installation indoors, free from electrically-conductive particles which are under temperature and humidity control, in order to reduce the risk of electric shock.

It is best to disconnect the device using the power supply cord. Ensure that the equipment is placed in a position near the outlet where easily accessible.







Except for replacing the batteries, all servicing on this equipment must be carried out by qualified service personnel.

Before conducting any maintenance, repair, or shipment, first ensure that everything is turned off completely and disconnected.

For additional safety instructions, please use the Safety Manual as a reference.

Special Symbols

The following symbols used on the UPS warn you of precautions:

	RISK OF ELECTRIC SHOCK - Please observe the warning that a risk of electric shock is present
	CAUTION: REFER TO OPERATOR'S MANUAL - Refer to the operator's manual for additional information, such as important operating and maintenance instructions.
	SAFE GROUNDING TERMINAL - Indicates primary safe ground
	LOAD ON/OFF - Pressing the button turns on/off the output receptacles and the indicator light.
	RJ45 RECEPTACLE - The receptacle provides network interface connections and telephone or telecommunications equipment should not be plugged into it.
	Please do not discard of the UPS or the UPS batteries as the UPS may have valve-regulated lead-acid batteries. Please recycle batteries appropriately.

Standards

Safety

IEC/EN 62040-1-1

EMI

Conducted Emissions	IEC/EN 62040-2	Category C3
Radiated Emissions	IEC/EN 62040-2	Category C3

EMS

ESD	IEC/EN 61000-4-2	Level 4
RS	IEC/EN 61000-4-3	Level 3
EFT	IEC/EN 61000-4-4	Level 4
SURGE	IEC/EN 61000-4-5	Level 4
CS	IEC/EN 61000-4-6	Level 3
Power-frequency		
Magnetic field	IEC/EN 61000-4-8	Level 3
Low frequency		
Signals	IEC/EN 61000-2-2	

Warning: This is a product for commercial and industrial applications. Installation in the appropriate environment is required.

Introduction

The information provided in this manual covers single phase 6000 and 10000 VA uninterruptible power systems, their basic functions, operating procedures, options available and emergency situations. It also includes information on how to ship, store, handle, and install the equipment. Only detailed requirements of the UPS units are described herein, and installation must be carried out in accordance with this manual. Electrical installation must also carefully follow local legislation and regulations. Only qualified personnel should conduct these installations as failure to acknowledge electrical hazards could prove to be fatal.

Product Description

Many different kinds of sensitive electrical equipment can be protected by an Uninterruptible Power Supply (UPS) including computers, workstations, process control systems, telecommunications systems, sales terminals, other critical instrumentation, etc. The purpose of the UPS is to protect these systems from poor quality utility power, complete loss of power, or other associated problems.

Electrical interference exists in many forms, causing problems in AC power, from lightning, power company accidents and radio transmission motors, air conditioners, and vending machines. Protection of sensitive electrical equipment is vital to protect against power outages, low or high voltage conditions, slow voltage fluctuations, frequency variations, differential and common-mode noise, transients, etc.

To prevent power line problems from reaching critical systems causing damage to software, hardware, and equipment malfunctions, the UPS maintains constant voltage, isolating critical load output and cleaning the utility AC power.

Double Conversion On-Line Technology

A double conversion on-line technology UPS provides completely isolated, clean, uninterrupted single-phase power to your critical systems, while maintaining the batteries for their maximum potential. In the event that the power failure lasts longer than the UPS backup time, the UPS will shut down avoiding battery damage. When the input AC voltage returns, the UPS will automatically return online to recharge the batteries.

As shown in the block diagram:

- An input filter reduces transients on the incoming utility.
- To maintain full battery charge, the AC input power is rectified and regulated in the rectifier feeding power

to the battery converter and inverter.

- DC power is converted to AC in the inverter, passing it on to the load.
- Power is maintained from the battery during a power failure.
- The converter increases voltage appropriately for the inverter.

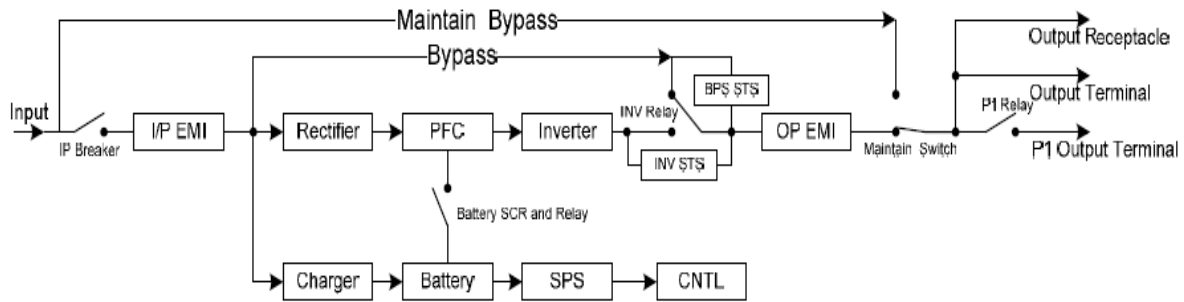

Block Diagram

Diagnostic Tests

When the UPS is started, a diagnostic test is automatically executed, checking the electronics and batteries, reporting any problems on the LCD display. A diagnostic test can also be performed manually from the front panel at any time.

System Configuration

The UPS device and the Extended Battery Pack (EBP) make up the system. Depending on the site and load requirements of the installation, certain additional options are available for the solution.

Planning a UPS system, the following should be taken into consideration:

- The total demand of the protected system shall dictate the output power rating (VA). Allow a margin for future expansion or calculation inaccuracies from measured power requirements.
- Backup time required will indicate the battery size needed. If the load is less than the UPS nominal power rating, then actual backup time is longer.
- The following options are available:
 - o Extended Battery Pack
 - » NXR-EBP20 for use with NX Ri-6K and NX Ri-10K
 - o Connectivity Options –SNMP/WEB card

See the Specification section of this manual for additional model information.



NX Ri FRONT VIEW

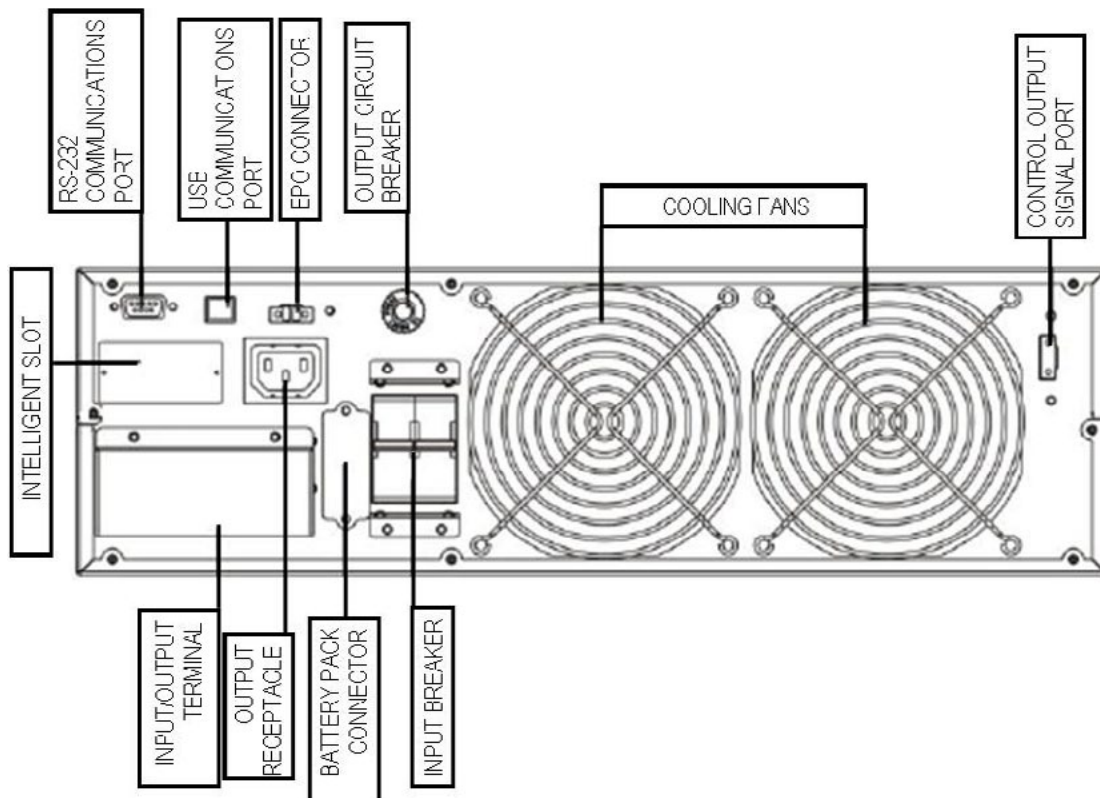

NXRi-6KL UPS REAR VIEW DIAGRAM (WITHOUT PARALLEL FUNCTION)

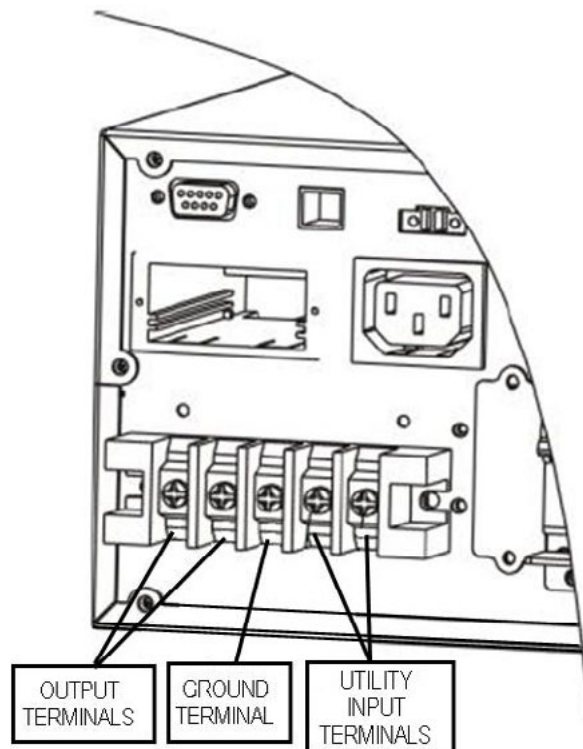

NXRi-6KL UPS REAR VIEW WIRING DIAGRAM

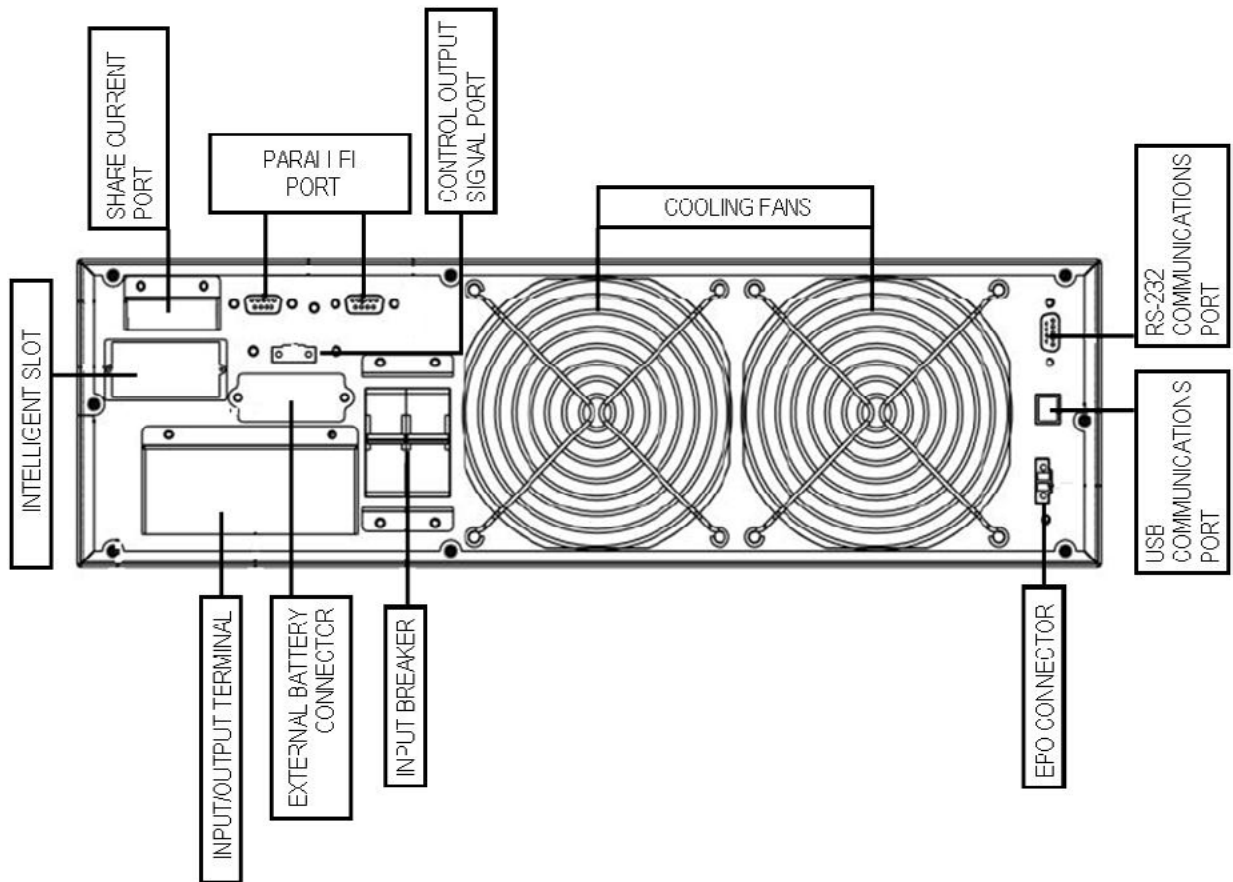

NXRi-10KL UPS REAR VIEW DIAGRAM (WITH PARALLEL FUNCTION)

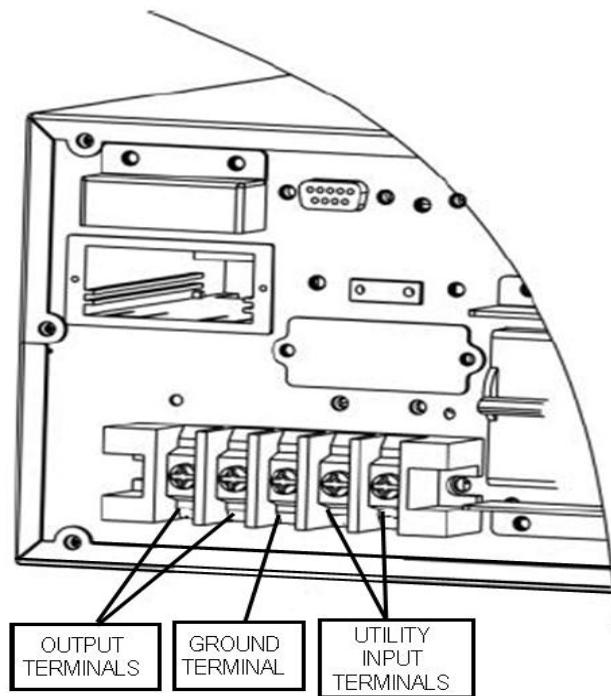

NXRi-10KL UPS REAR VIEW WIRING DIAGRAM

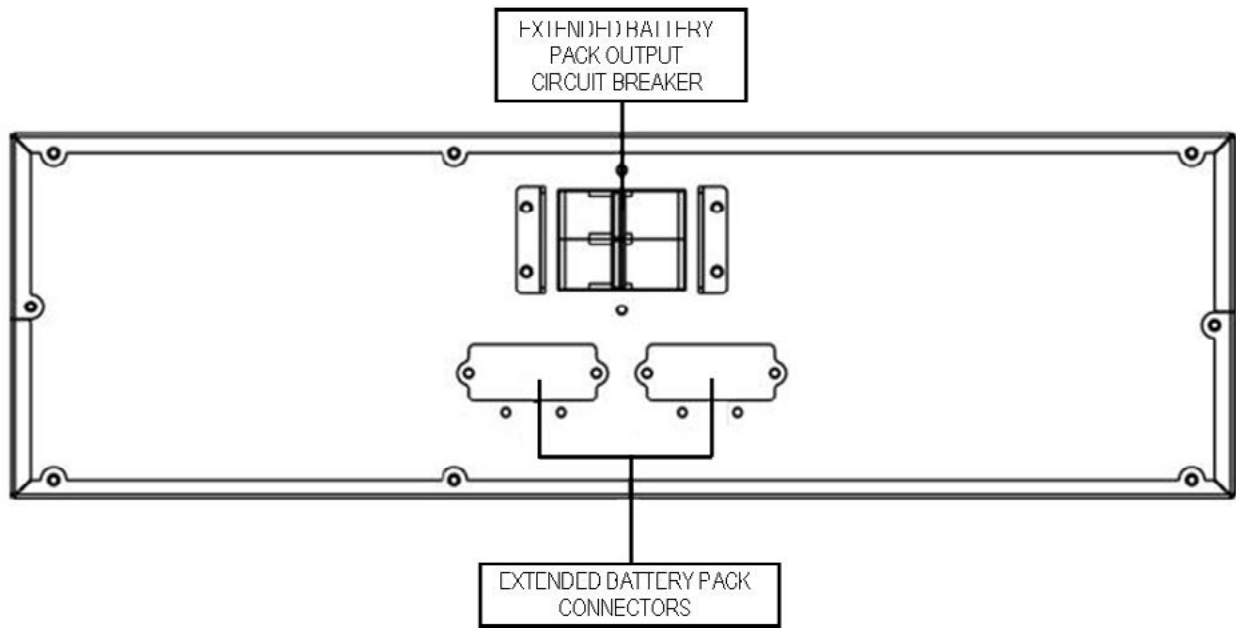

NXri-EBP20 REAR VIEW DIAGRAM

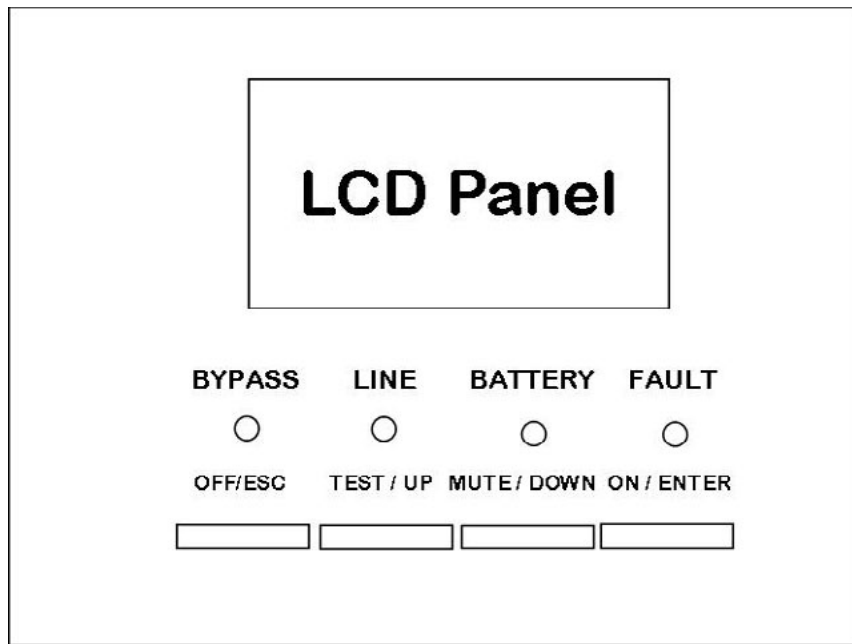

LCD PANEL

LED & LCD Descriptions

For details of the LED and LCD Operations please refer to the Operations section of this document

Bypass LED

Illuminates during UPS Startup, Bypass Mode, Battery Test, and ECO Mode of operation.

Line LED

Illuminates during UPS Startup, AC Mode, CVCF Mode, Battery Test, and ECO Mode of operation.

Battery LED

Illuminates during UPS Startup, Battery Mode, and Battery Test Mode of operation.

Fault LED

Illuminates during UPS Startup and Fault Mode of operation.

RS-232 Standard Interface

The RS-232 interface uses a 9-pin female D-sub connector. Information provided includes data about utility, load and the UPS. The interface port pins and their functions are identified in the following table:



PIN #	FUNCTIONS
1,4,6,7,8,9	Reserved
2	UPS transmit
3	UPS receive
5	Ground

SNMP Communications Option

The UPS provides an intelligent slot for internal or external network card. This special intelligent network card can be compatible with popular software and hardware found on the web and in operating systems. It can support operating systems such as HP Open View, IBM Netview, SUN Netmanager, etc. This enables the UPS to provide instant UPS and power information over the network. Please contact your reseller for additional details.

Remote Emergency Power Off (REPO) Port

A customer supplied switch located remotely can be used to close the REPO connection and allows the UPS output receptacles to be switched off. Since the REPO shuts down the equipment immediately, orderly shutdown procedures are not followed by any power management software. The UPS will have to be manually restarted in order to regain power to the outlets on the UPS.

Hardware Installation Guide

Inspect the UPS upon receipt. The packaging is recyclable; keep it for reuse or dispose of properly.

Safety Information

Information presented here is vital to all personnel. Please read all Safety information.

Storage and Transportation

Please handle the UPS and associated equipment with extreme caution since a high amount of energy is contained in the batteries. Always keep the unit in an upright position as marked on the packaging, and never drop the unit.

Please adhere to the following instructions if the UPS is not installed immediately:

- Store the equipment as is in its original packing and shipping carton.
- Do not store in temperatures outside the range of -15°C to +25°C
- Ensure that the equipment is fully protected from wet or damp areas and from moist air.

In order to maintain the batteries, the UPS should be recharged every 6 months for at least 8 hours.

If flammable substances such as gases or fumes are present, or if the room is airtight, a hazardous situation may exist in which no electrical equipment should be operated.

The instructions in this manual explain how to install the UPS safely. Not acknowledging such electrical hazards may be fatal – keep this manual for future reference.

**WARNING!**

It is strongly recommended that the UPS cabinet not be opened as components have very high voltage and touching those components may be fatal. Only a qualified technician or authorized agent may service the unit.

The UPS unit's output receptacles carry live voltage even when not connected to an input voltage source. The UPS has its own internal energy source.

Environment

Ensure that all environmental concerns and requirements are met according to specifications listed in this document, otherwise the safety of installation personnel cannot be guaranteed, and the unit may malfunction.

Ensure that you remember the following when locating the UPS system and battery options:

- Avoid extremes of temperature and humidity. Maximum battery life can be attained with a recommended temperature range of +15°C to +25°C.
- Provide protection for the equipment from moisture.
- Space and ventilation requirements must be met. Ensure there is 100mm to the front and rear of the UPS and Battery Pack for proper ventilation.
- Ensure that the front of the UPS remains clear for user operation.

Rack-Mount Installation (Using 4-Post Rail Kit)

Package contents

- Right and left rail sliders, 1 each
- (2) M6 nuts
- (12) M6 screws

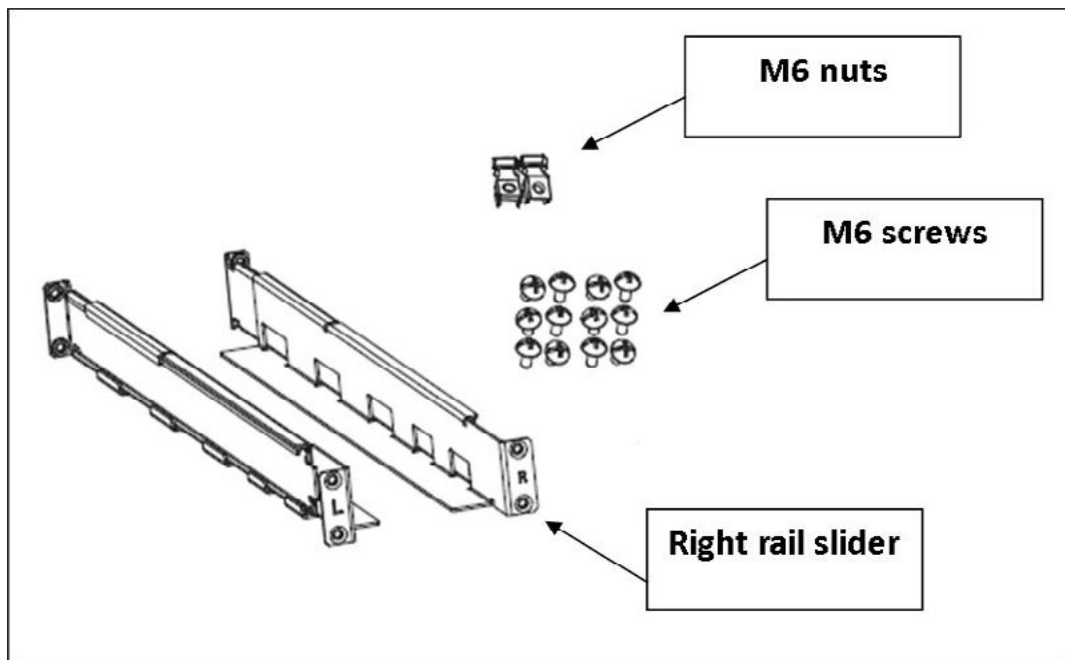

Step 1

Use 4 screws to mount right and left rail sliders in front of rack.

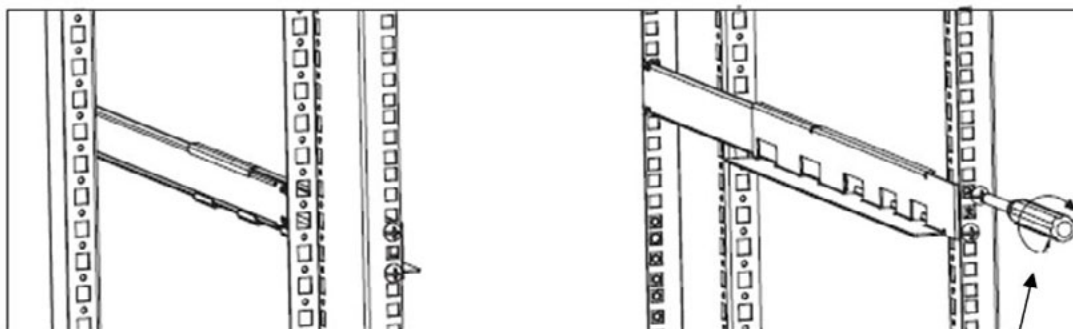

Screw driver

Step 2

Use 4 screws to mount right and left rail sliders in back of rack.

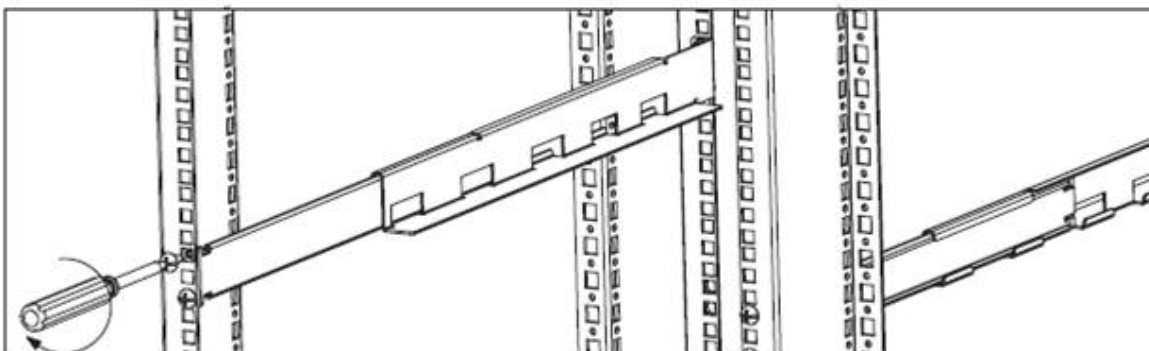

Step 3

Place the nuts in the proper location in the rack based upon height of UPS.

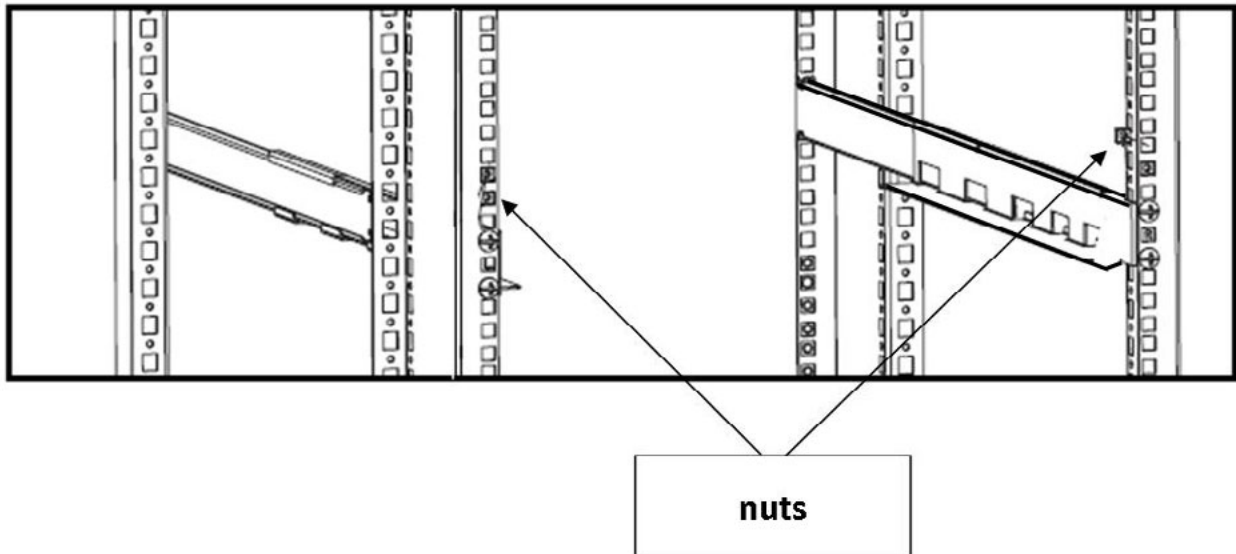

Step 4

Carefully place the UPS on the rail support.

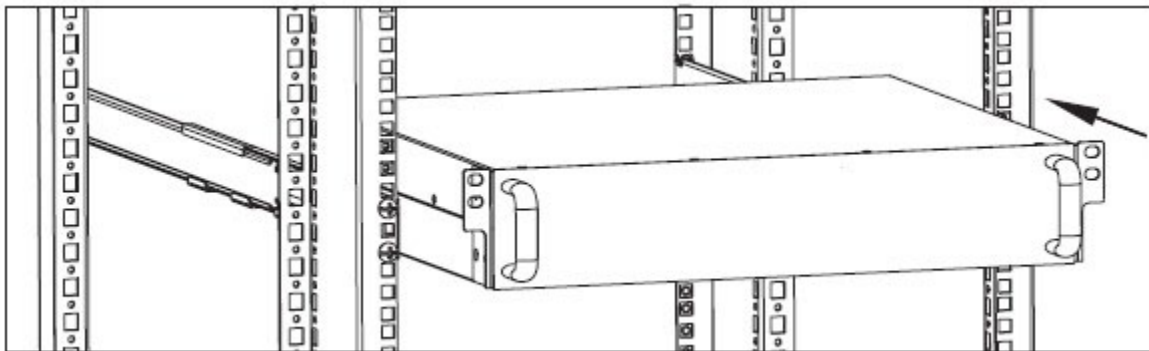

Step 5

Fix the UPS in position with screws.

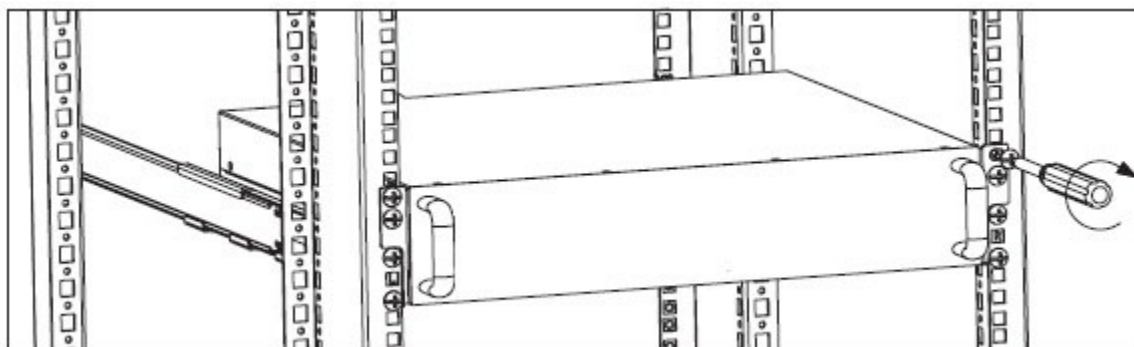

Step 6

Rail kit installation is now complete.

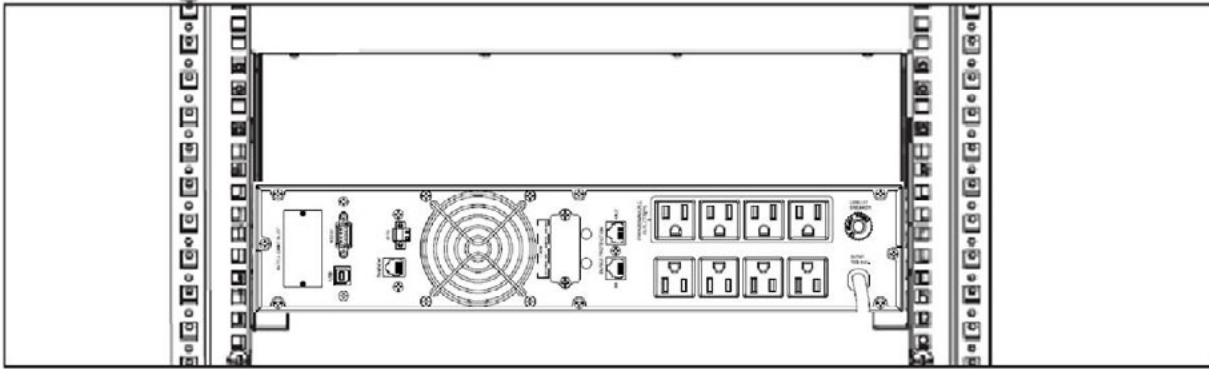
**UPS Installation**

Installation and wiring must be performed in accordance with the local electrical laws and regulations, and performed by appropriate personnel.

1. Make sure the utility wire and circuit breakers are rated per the capacity of the UPS to avoid hazards of electrical shock or fire.
Note: Do not use a wall receptacle as the input power for the UPS as its rated current is less than the UPS maximum input current.
2. Switch off the utility circuit breaker before installation.
3. Turn off all connected devices before connecting to the UPS.
4. Wiring sizes should be installed in accordance with the following table:

Model	Wiring specification (AWG)			
	INPUT	OUTPUT	BATTERY	GROUND
6KL	10	10	10	10
10KL	8	8	8	8

Note: The cable for 6K should be able to withstand over 40A current. It is recommended to use 10AWG or thicker wire for safety and efficiency.

Note: The cable for 10K should be able to withstand over 63A current. It is recommended to use 10AWG or thicker wire for safety and efficiency.

Note: The selections for color of wires should be in accordance with the local electrical laws and regulations

5. Remove the terminal block cover on the rear panel of the UPS. Connect the wires according to the following terminal block diagrams:

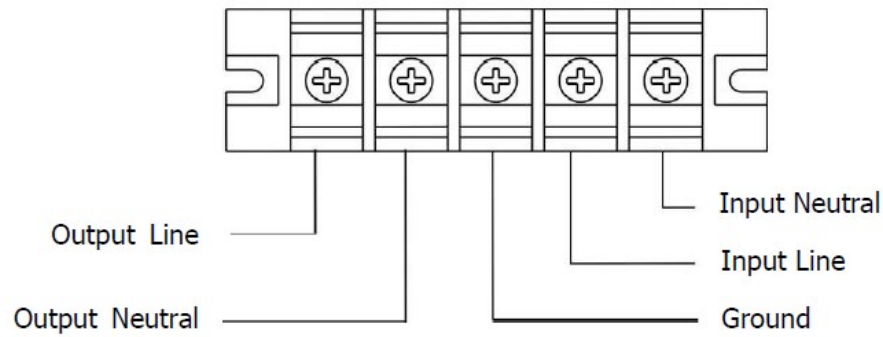

UPS TERMINAL BLOCK WIRING DIAGRAM

Note: Make sure that the wires are connected tightly with the terminals.

Note: There are two kinds of outputs for the 6K / 10K: output terminal / outlets and programmable terminal. Please connect non-critical loads to the programmable terminal and critical devices to the output terminal / outlets. During a power failure, you may extend the backup time to critical devices by setting shorter backup time for non-critical devices.

Note: Please install an output breaker between the output terminal and the load. The breaker should be qualified with leakage current protection function if necessary.

6. Insert the EPO plug into the EPO slot on the rear panel.
7. Put the terminal block cover back onto the rear panel of the UPS and EBP.

UPS Installation for Parallel Systems

If the UPS is only available for single operation, you may skip this section.

1. Install wiring as instructed in UPS Installation section.
2. Connect the output wires of each UPS to an output breaker.
3. Connect all output breakers to a major output breaker. The major output breaker will then directly connect to the loads.
4. Each UPS must be connected to an independent battery pack.
5. Remove the cover of the parallel share current cable port on the UPS. Connect each UPS one by one with the parallel cable and share current cable. Reattach the cover.
6. Refer to the following wiring diagrams:

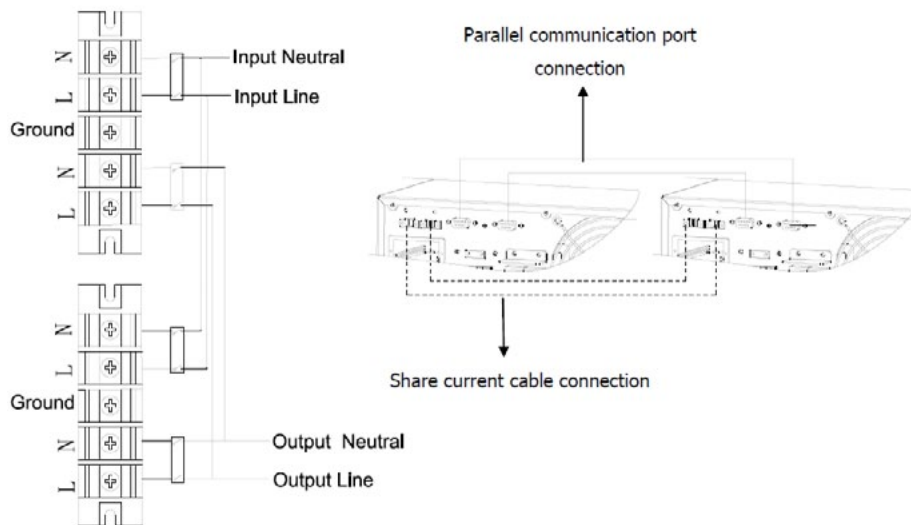

PARALLEL SYSTEM CABLE CONNECTIONS

Warning:

- Make sure the UPS is not turned on before installation. The UPS should not be turned on during wiring connection.
- There is one DC breaker to disconnect the battery pack from the UPS. Make sure this DC breaker is in the off position.

Note: Set the battery pack breaker to "OFF" position and then install the battery pack.

- Attention should be paid to the rated battery voltage marked on the rear panel. If you want to change the numbers of battery packs, please make sure you modify the setting simultaneously. The connection with wrong battery voltage may cause permanent damage to the UPS. Make sure the voltage of the battery pack is correct.
- Attention should be paid to the polarity marking on external battery terminal block, making sure that the correct battery polarity is connected. Wrong connection may cause permanent damage to the UPS.
- Make sure the protective earth ground wire is correctly installed. The wire current specification, color, position, connection, and conductance reliability should be checked carefully.
- Make sure the utility input and output wiring is correct. The wire current specification, color, position, connection, and conductance reliability should be checked carefully. Make sure the L/N location is correct, not reversed or short-circuited.

Battery Pack Installation

Follow the basic procedures for UPS rack installation if required. A rail kit should be used with each battery pack when being installed in a 4-post rack. Then make the connections as shown in the diagrams below.

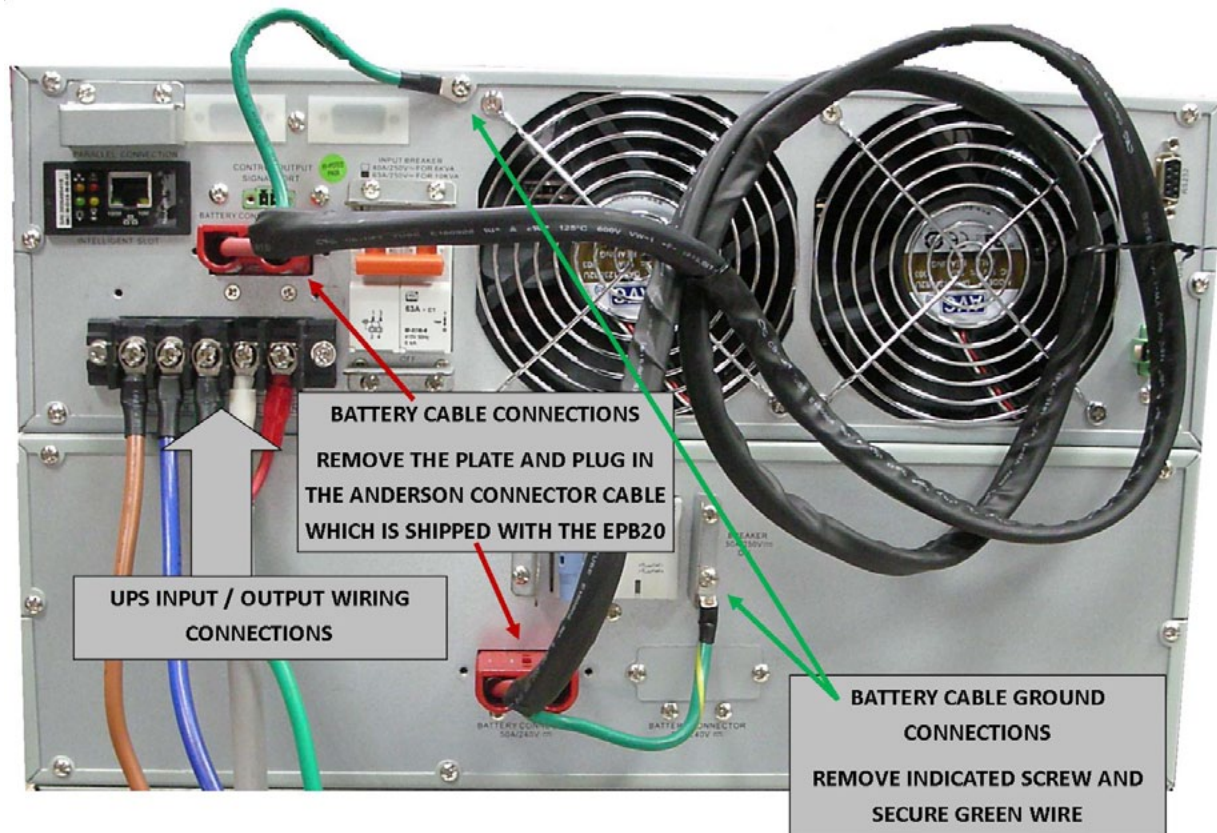
**Software Installation**

For optimal system protection, install UPS monitoring software to fully configure UPS shutdown.

Operations

Button Operation

The only operations that users are permitted to do are:

Button	Function
ON/Enter Button	<ul style="list-style-type: none"> Turn on the UPS: Press and hold the button more than 0.5s to turn on the UPS. Enter Key: Press this button to confirm the selection in setting menu.
OFF/ESC Button	<ul style="list-style-type: none"> Turn off the UPS: Press and hold the button more than 0.5s to turn off the UPS. Esc key: Press this button to return to last menu in setting menu.
Test/Up Button	<ul style="list-style-type: none"> Battery test: Press and hold the button more than 0.5s to test the battery while in AC mode, or CVCF* mode. UP key: Press this button to display next selection in setting menu.
Mute/Down Button	<ul style="list-style-type: none"> Mute the alarm: Press and hold the button more than 0.5s to mute the buzzer. Down key: Press this button to display previous selection in setting menu.
Test/Up + Mute/Down Button	<ul style="list-style-type: none"> Press and hold the two buttons simultaneous more than 1s to enter/escape the setting menu.

LED Indicators and LCD Panel

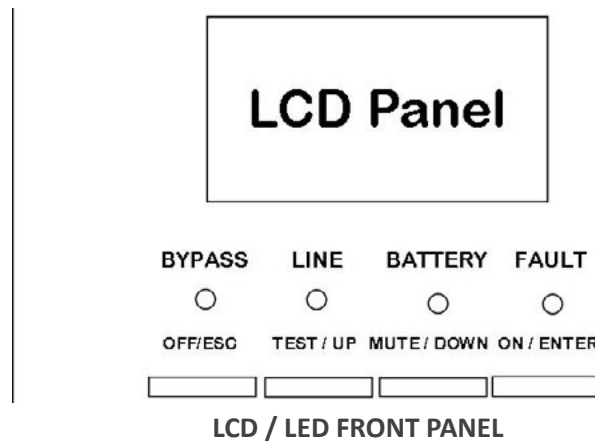

LED Indicators:

There are 4 LEDs on the front panel to show the UPS working status







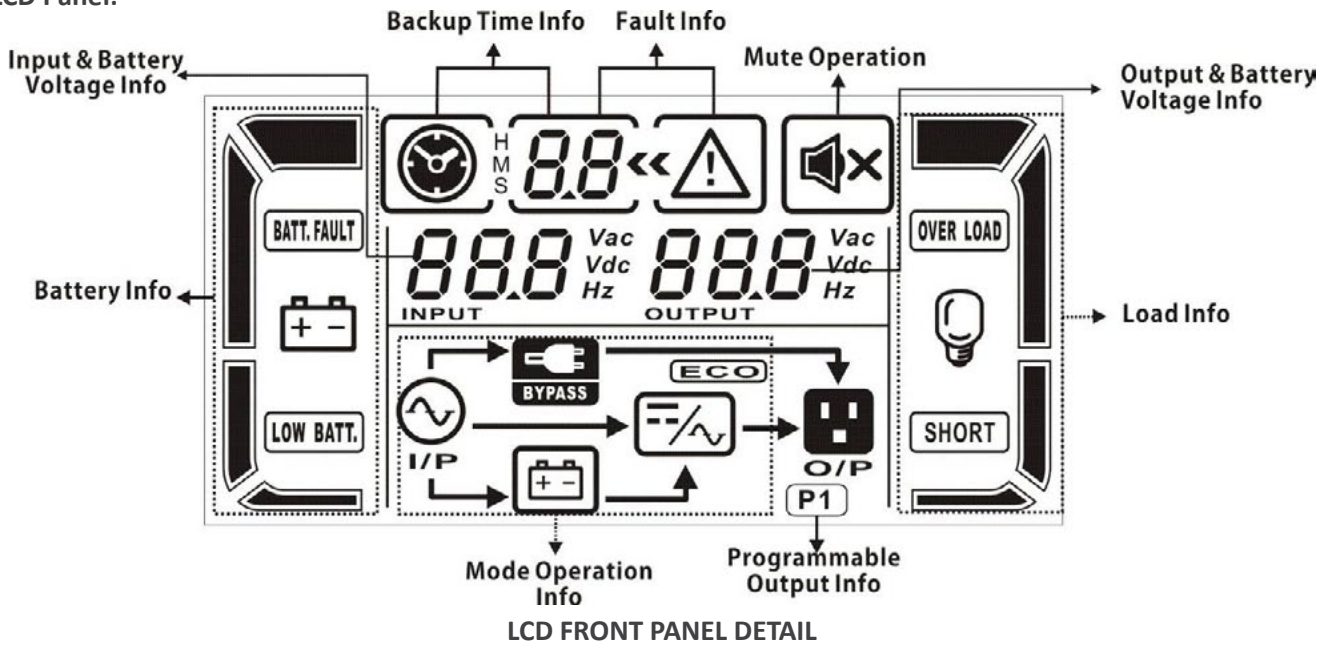



Mode	Bypass	Line	Battery	Fault
UPS Startup	●	●	●	●
Bypass mode	●	○	○	○
AC mode	○	●	○	○
Battery mode	○	○	●	○
CVCF mode	○	●	○	○
Battery Test	●	●	●	○
ECO mode	●	●	○	○
Fault	○	○	○	●

Note: ● means LED is illuminated ○ means LED is not illuminated

LCD Panel:



Display	Function
Backup time information	
	Indicates the battery discharge time in numbers H: hours, M: minutes, S: seconds
Fault information	
	Indicates that the warning and fault occurs.
	Indicates the fault codes
Mute operation	
	Indicates that the UPS alarm is disabled.
Output & Battery voltage information	
	Indicates the output voltage, frequency or battery voltage. Vac: output voltage, Vdc: battery voltage, Hz: frequency
Load information	
	Indicates the load level by 0-25%, 26-50%, 51-75%, and 76-100%.
	Indicates overload.
	Indicates the load or the output is short.
Programmable output information	

	Indicates that the programmable outputs are working.
Mode operation information	
	Indicates the UPS connects to the mains.
	Indicates the battery is working.
	Indicates the bypass circuit is working.
	Indicates the ECO mode is enabled.
	Indicates the Inverter circuit is working.
	Indicates the output is working.
Battery information	
	Indicates the Battery capacity by 0-25%, 26-50%, 51-75%, and 76-100%.
	Indicates the battery is not connected.
	Indicates low battery level and low battery voltage.
Input & Battery voltage information	
	Indicates the input voltage or frequency or battery voltage. Vac: Input voltage, Vdc: battery voltage, Hz: input frequency

Audible Alarms

Description	Buzzer status	Muted
UPS status		
Bypass mode	Beeping once every 2 minutes	Yes
Battery mode	Beeping once every 4 seconds	
Fault mode	Beeping continuously	
Warning		

Overload	Beeping twice every second	No
Low battery	Beeping once every second	
Battery unconnected		
Over charge		
EPO enable		
Fan failure		
Over temperature		
Charger failure		
L1 IP fuse broken		
Battery fuse broken		
Overload 3 times in 30min		
IP Neutral loss		
IP phase abnormal		
Converter Current unbalance		
Inverter Current unbalance		
Cover of maintain switch is open		
Phase auto adapt failure		
Fault		
Bus start failure	Beeping continuously	Yes
Bus over		
Bus under		
Bus unbalance		
Converter over current		
Inverter soft start failure		
High Inverter voltage		
Low Inverter voltage		
Inverter output short circuited		
Negative power fault		
Battery SCR short circuited		
Inverter relay short circuited		
Battery fuse broken in battery mode		
Parallel communication failure		
Parallel output current unbalance		

UPS Operation

Turn on the UPS with Utility Power (in AC Mode)

1. After the UPS is connected correctly to AC utility, set the breaker on the battery pack at "ON" position.
2. Set the input breaker to "ON" position.
3. At this point the fan will be running and the UPS will supply power to the loads via the bypass. The UPS is operating in Bypass Mode.

Note: When the UPS is in Bypass Mode, the output voltage will directly power the load from utility after you have switched on the input breaker. In Bypass Mode, the load is not protected by the UPS. To protect your load devices you should turn on the UPS.

4. Press and hold the "ON" button for 0.5 seconds to turn on the UPS. The buzzer will beep once.
5. A few seconds later the UPS will enter AC mode. If the utility power is abnormal, the UPS will operate in Battery Mode without interruption.

Note: When the UPS is running out of battery time it will shut down automatically at Battery Mode. When the utility power is restored the UPS will auto restart in AC mode.

Turn on the UPS without Utility Power (in Battery Mode)

1. Make sure that the breaker on the battery pack is in the "ON" position
2. Press and hold the "ON" button for 0.5 seconds to turn on the UPS. The buzzer will beep once.
3. A few seconds later the UPS will be turned on and enter Battery Mode.

Connecting devices to the UPS

After the UPS is turned on you can connect devices to the UPS.

1. Turn on the UPS first and then switch on the devices one by one. The LCD Panel will display the total load level.
2. If it is necessary to connect inductive loads such as a printer, the in-rush current should be calculated to see if it is less than the available capacity of the UPS. Power consumption by inductive loads can easily exceed the available capacity during startup.
3. If the UPS is Overloaded, the buzzer will beep twice each second.
4. When the UPS is Overloaded, remove some loads immediately. It is recommended to have the total loads connected to the UPS equal less than 80% of the nominal power capacity to prevent overload conditions.
5. If the Overload time is over the acceptable time shown in the specification for AC Mode, the UPS will automatically transfer to Bypass Mode. After the Overload is removed, the UPS will return to AC Mode. If the Overload time is over acceptable time listed in the specification for Battery Mode, the UPS will appear in Fault Status. At this time, if Bypass is enabled, the UPS will power the loads via Bypass. If Bypass function is disabled or the input power is not within Bypass range, the UPS will shut off output immediately.

Charging the Batteries

1. After the UPS is connected to utility power, the charger will start to charge the batteries automatically except if the UPS is in Battery Mode or during Battery Self-Test.
2. It is suggested to charge the batteries at least 10 hours before use to assure proper backup time.
3. Make sure the battery number setting on the control board is consistent to the real connection.

Battery Mode Operation

1. When the UPS is in Battery Mode, the buzzer will beep according to battery capacity.
 - a. If the battery capacity is more than 25%, the buzzer will beep once every 4 seconds.
 - b. If the battery voltage drops to the alarm level, the buzzer will beep once every second to indicate that the battery is at a low level and the UPS will soon shut down automatically. Shutting down non-critical loads at this point will prolong the backup time. If the programmable timer function is enabled, the UPS will shut off programmable output terminals automatically.

Note: There is a risk of data loss or load failure if battery runtime is exceeded.

2. In Battery Mode, to silence the buzzer sound, press the Mute Button.

3. The backup time depends on the external battery capacity.
4. The backup time may vary depending upon environmental conditions and load types.
5. When setting the backup time for 16.5 hours (default value from LCD panel), after discharging for 16.5 hours, the UPS will shut down automatically to protect the battery. This battery discharge protection can be enabled or disabled via the LCD Panel Control.

Testing the Batteries

1. To check the Battery Status while the UPS is running in AC Mode, CSCF Mode, or ECO Mode press the "Test" button for the UPS Battery Self-Test.
2. To keep the UPS reliable, the UPS will perform the Battery Self-Test automatically on a periodic basis. The default setting for this Battery Self-Test is once per week.
3. Battery Self-Test interval can also be set through the monitoring software.
4. If the UPS is in Battery Self-Test Mode, the LCD Display and buzzer indication will be the same as in Battery Mode, except that the Battery LED is flashing.

Turn off the UPS with Utility Power in AC Mode

1. Turn off the inverter of the UPS by pressing "OFF" button for at least 0.5 seconds. The buzzer will beep once. The UPS will change to Bypass Mode.
Note: If the UPS has been set to enable the bypass output, it will bypass voltage from utility power to output sockets and terminals even though the UPS (inverter) has been turned off.
Note: After turning off the UPS, please beware that the UPS is operating in Bypass Mode and there is a risk of power loss for connected devices.
2. In Bypass Mode, output voltage of the UPS is still present. In order to shut off the output voltage, switch off the input breaker to the UPS. A few seconds later there will be no display shown on the Display Panel of the UPS and the UPS is now completely turned off.

Turn off the UPS without Utility Power in Battery Mode

1. Turn off the UPS by pressing "OFF" button for at least 0.5 seconds. The buzzer will beep once.
2. UPS power will shut off to the output and there will be no display showing on the display panel.

Muting the Buzzer

1. To mute the buzzer, please press the "Mute" button for at least 0.5 seconds. If you press the mute button again after the buzzer is muted, the buzzer will sound again.
2. Some warning alarms cannot be muted unless the error is fixed.

Operation in Warning Status

1. When the Fault LED flashes and the buzzer sounds once every second, there is some problem with the UPS operation. Fault Codes are available via the LCD Panel. Refer to the Trouble Shooting table for additional details.
2. Some warning alarms cannot be muted unless the error is fixed.

Operation in Fault Mode

1. When the Fault Mode LED is illuminated and the buzzer sounds continuously, there is a fatal error in the UPS. Fault Codes are available via the LCD Panel. Refer to the Trouble Shooting table for additional details.
2. Check the loads, wiring, ventilation, utility, battery, etc when a fault occurs. Do not try to turn the UPS on again before solving the problems. If the problems cannot be fixed, please contact trained service personnel immediately.
3. In case of emergency, disconnect the UPS from the utility, external battery, and output immediately to avoid danger.

Operation of Changing Battery Numbers

1. This operation should only be performed by trained and qualified professionals.

2. Turn off the UPS. If the load cannot be shut down, remove the cover from the Maintenance Bypass Switch on the rear panel of the UPS, and turn the Maintenance Bypass Switch to "BPS" position.
3. Switch off the input breaker and battery breaker.
4. Remove the UPS cover. Modify the jumper on the control board to set the battery numbers. Disconnect the battery wire for standard model and modify the battery pack carefully. After completing the changes, replace UPS cover.
Note: JP1 setting on the control board: Jumper placed on Pin 5 & 6 and Pin 7 & 8 for 20 pieces of batteries; Jumper placed on Pin 5 & 6 or Pin 7 & 8 for 19 pieces of batteries; keep every Pin open for 18 pieces of batteries.
5. Switch the input breaker "ON" and the UPS will enter Bypass Mode. If the UPS is in Maintenance Bypass Mode, turn the Maintenance Bypass Switch to "UPS" position and then turn on the UPS.

Parallel Operation

Parallel System Connection

1. Make sure all of the UPSs are parallel models, and assure all are wired properly.
2. Turn off the input and output breakers of each UPS, and turn off the battery breaker if the UPS is a long runtime model (10KL).
3. Turn on the input breaker of each UPS and measure the voltage difference between the Output Line 1 of each UPS with multimeter. If the voltage difference is less than 1V, all connections are correct. If the difference is larger than 1V, check the wiring is properly completed.
4. Turn on the input breakers of all UPS in the parallel systems. Before turning on each UPS, check PAR001~PAR003 are displayed in each UPS sequentially. If no "PARXXX" exists in any UPS, check to see if the parallel cables are correctly connected.
5. Turn on each UPS in sequence and make sure the AC mode LED or Battery mode LED display in each UPS. Measure the output voltage of each UPS to check to see that the voltage difference is less than 2V (typically 1V) with multimeter. If the difference is more than 2V, check that parallel cables and/or share current cables are connected well. If they are all connected well, the UPS may have an internal issue. Contact your distributor for further assistance.
6. Turn off each UPS in sequence. After all of the UPS are transferred to Bypass mode, turn on the output breaker for each unit.
7. Turn on the UPS in AC mode. Parallel system connections and configuration should now be complete.

Add one new unit into the Parallel System

1. You cannot add one new UPS into a Parallel System while the whole system is operating. All loads must be powered down and each UPS in the system must be powered down before proceeding.
2. Make sure all of the UPS are Parallel Models, following Input Wiring Instructions shown earlier in this manual.
3. Install the new UPS and follow instructions in the previous section for proper connection, testing, and startup.

Remove one unit from the Parallel System

There are two methods that can be used to remove one UPS from the parallel system:

Method #1







1. Press the "OFF" button twice for about 0.5 seconds each. The UPS will enter into bypass mode without output.
2. Turn off the output breaker of the UPS, and then turn off the input breaker of the UPS.
3. After the UPS shuts down, turn off the battery breaker and remove the parallel cable and share current cable. You can now remove the UPS from the parallel system.

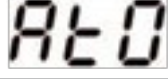

Method #2

1. If the bypass is abnormal, you cannot remove the UPS without interruption. You must power down the load and shut down the UPS.
2. Enable the Bypass setting in each UPS and then power off the running UPS. All UPS units in the parallel system will transfer to Bypass mode. Remove all maintenance bypass covers and set the maintenance switches from "UPS" to "BPS". Turn off the input breakers and battery breakers.
3. Remove the desired UPS.
4. Turn on the input breaker of the remaining UPS and the system will transfer to Bypass mode.
5. Set the maintenance switches from "BPS" to "UPS" and re-install the maintenance bypass covers. Turn on the remaining UPS and finish the parallel system connections.

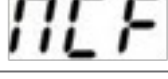
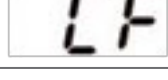
Warning: (Parallel System Only)

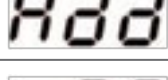
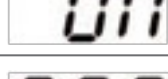
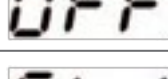
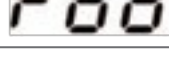
- Before turning on the parallel system to activate the inverter, make sure that all UPS Maintenance switches are in the same position.
- When parallel system is turned on to operate through the inverter, please do not operate the Maintenance switch of any UPS.

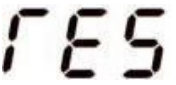
Abbreviation	Display content	Meaning
ENA		Enable
DIS		Disable
ATO		Auto
BAT		Battery
NCF		Normal mode (not CVCF mode)
CF		CVCF mode
SUB		Subtract
ADD		Add
ON		On
OFF		Off
FBD		Not allowed

OPN		Allow
RES		Reserved
PAR		Parallel, 001 means the first UPS

LCD Parameter Settings

There are three parameters to set up the UPS. Refer to the following diagram.

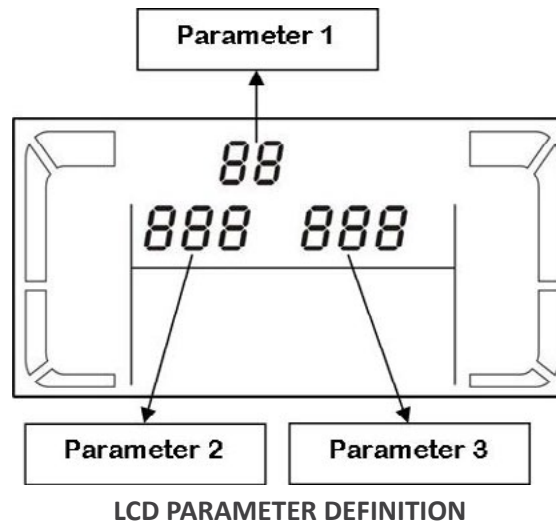

Parameter 1: for program alternatives – there are 15 programs to set up – refer to the table below
Parameter 2 and 3: are the setting options or values of each program

15 programs available list for parameter 1:

Code	Description	Bypass	AC	ECO	CVCF	Battery	Battery Test
01	Output voltage	Y					
02	Output frequency	Y					
03	Voltage range for bypass	Y					
04	Frequency range for bypass	Y					
05	ECO mode enable/disable	Y					
06	Voltage range for ECO mode	Y					
07	ECO mode frequency range setting	Y					
08	Bypass mode setting	Y	Y				
09	Battery backup time setting	Y	Y	Y	Y	Y	Y
10	(not used for these models)	N/A					
11	(not used for these models)	N/A					
12	Hot standby function enable/disable	Y	Y	Y	Y	Y	Y

13	Battery voltage adjustment	Y	Y	Y	Y	Y	Y
14	Charger voltage adjustment	Y	Y	Y	Y	Y	Y
15	Output voltage adjustment		Y		Y	Y	

*Y means that this program can be set in this mode.

01: Output Voltage Settings

Interface	Setting
	<p>Parameter 3: Output voltage You may choose the following output voltage in parameter 3: 208: Presents output voltage is 208Vac 220: Presents output voltage is 220Vac 230: Presents output voltage is 230Vac 240: Presents output voltage is 240Vac</p>

02: Output Frequency Settings

Interface	Setting
<p>60 Hz, CVCF mode</p>	<p>Parameter 2: Output Frequency Setting the output frequency. You may choose following three options in parameter 2: 50.0Hz: The output frequency is setting for 50.0Hz. 60.0Hz: The output frequency is setting for 60.0Hz. ATO: If selected, output frequency will be decided according to the latest normal utility frequency. If it is from 46Hz to 54Hz, the output frequency will be 50.0Hz. If it is from 56Hz to 64Hz, the output frequency will be 60.0Hz. ATO is default setting.</p> <p>Parameter 3: Frequency mode Setting output frequency at CVCF mode or not CVCF mode. You may choose following two options in parameter 3: CF: Setting UPS to CVCF mode. If selected, the output frequency will be fixed at 50Hz or 60Hz according to setting in parameter 2. The input frequency could be from 46Hz to 64Hz. NCF: Setting UPS to normal mode (not CVCF mode). If selected, the output frequency will synchronize with the input frequency within 46~54 Hz at 50Hz or within 56~64 Hz at 60Hz according to setting in parameter 2. If 50 Hz selected in parameter 2, UPS will transfer to battery mode when input frequency is not within 46~54 Hz. If 60Hz selected in parameter 2, UPS will transfer to battery mode when input frequency is not within 56~64 Hz. *If Parameter 2 is ATO, the Parameter 3 will show the current frequency.</p>
<p>50 Hz, Normal mode</p>	
<p>ATO</p>	

03: Voltage Range for Bypass

Interface	Setting
 <p>The LCD display shows '03<<' at the top. Below it, '176 Vac' and '264 Vac' are displayed. At the bottom, there is a 'BYPASS' icon.</p>	<p>Parameter 2: Set the acceptable low voltage for bypass. Setting range is from 110V to 209V and the default value is 110V.</p> <p>Parameter 3: Set the acceptable high voltage for bypass. Setting range is from 231V to 276V and the default value is 264V.</p>

04: Frequency Range for Bypass

Interface	Setting
 <p>The LCD display shows '04<<' at the top. Below it, '46.8 Hz' and '53.8 Hz' are displayed. At the bottom, there is a 'BYPASS' icon.</p>	<p>Parameter 2: Set the acceptable low frequency for bypass. 50 Hz system: Setting range is from 46.0Hz to 49.0Hz. 60 Hz system: Setting range is from 56.0Hz to 59.0Hz. The default value is 46.0Hz/56.0Hz.</p> <p>Parameter 3: Set the acceptable high frequency for bypass. 50 Hz: Setting range is from 51.0Hz to 54.0 Hz. 60 Hz: Setting range is from 61.0Hz to 64.0Hz. The default value is 54.0Hz/64.0Hz.</p>

05: ECO mode enable/disable

Interface	Setting
 <p>The LCD display shows '05<<' at the top. Below it, 'd1 5' is displayed. At the bottom, there is an 'ECO' icon.</p>	<p>Parameter 3: Enable or disable ECO function. You may choose following two options: DIS: disable ECO function ENA: enable ECO function</p> <p>If ECO function is disabled, voltage range and frequency range for ECO mode still can be set, but it is meaningless unless the ECO function is enabled.</p>

06: Voltage Range for ECO Mode

Interface	Setting
 <p>The LCD display shows '06<<' at the top. Below it, '209 Vac' and '231 Vac' are displayed. At the bottom, there is an 'ECO' icon.</p>	<p>Parameter 2: Low voltage point in ECO mode. The setting range is from -5% to -10% of the nominal voltage.</p> <p>Parameter 3: High voltage point in ECO mode. The setting range is from +5% to +10% of the nominal voltage.</p>

07: Frequency Range for ECO Mode

Interface	Setting
	<p>Parameter 2: Set low voltage point for ECO mode. 50 Hz system: Setting range is from 46.0Hz to 48.0Hz. 60 Hz system: Setting range is from 56.0Hz to 58.0Hz. The default value is 48.0Hz/58.0Hz.</p> <p>Parameter 3: Set high voltage point for ECO mode. 50 Hz: Setting range is from 52.0Hz to 54.0 Hz. 60 Hz: Setting range is from 62.0Hz to 64.0Hz. The default value is 52.0Hz/62.0Hz.</p>



08: Bypass Mode Settings

Interface	Setting
	<p>Parameter 2: OPN: Bypass allowed. When selected, UPS will run at Bypass mode depending on bypass enabled/disabled setting. FBD: Bypass not allowed. When selected, it's not allowed for running in Bypass mode under any situations.</p> <p>Parameter 3: ENA: Bypass enabled. When selected, Bypass mode is activated. DIS: Bypass disabled. When selected, automatic bypass is acceptable, but manual bypass is not allowed. Manual bypass means users manually operate UPS for Bypass mode. For example, pressing OFF button in AC mode to turn into Bypass mode.</p>



09: Bypass Backup Time Settings

Interface	Setting
	<p>Parameter 3: 000~999: Set the maximum discharge time from 0 min to 999 min. UPS will shut down to protect battery if the discharge time arrives before the battery is under voltage. The default value is 990 min. DIS: Disable battery discharge protection and backup time will depend on battery capacity.</p>

10: Programmable Output Settings

Interface	Setting
	<p>This function not supported in this model.</p>
	

11: Shutdown Point for Programmable Output

Interface	Setting
	<p>This function not supported in this model.</p>
	<p>This function not supported in this model.</p>

12: Hot standby function enable/disable

Interface	Setting
	<p>Parameter 2: HS.H Enable or disable Hot standby function. You may choose the following two options in Parameter 3: YES: Hot standby function is enabled. It means that the current UPS is set to host of the hot standby function, and it will restart after AC recovery even without battery connected. NO: Hot standby function is disabled. The UPS is running at normal mode and can't restart without battery.</p>

13: Battery Voltage Adjustment

Interface	Setting
	<p>Parameter 2: Select “Add” or “Sub” function to adjust battery voltage to real figure.</p> <p>Parameter 3: the voltage range is from 0V to 5.7V, the default value is 0.09V.</p>

14: Charger Voltage Adjustment

Interface	Setting
	<p>Parameter 2: you may choose Add or Sub to adjust charger voltage</p> <p>Parameter 3: the voltage range is from 0V to 7V, the default value is 1.1V.</p> <p>NOTE:*Before making voltage adjustment, be sure to disconnect all batteries first to get the accurate charger voltage. We strongly suggest using the default value (0). Any modification should be suitable to battery specifications.</p>

15: Output Voltage Adjustment



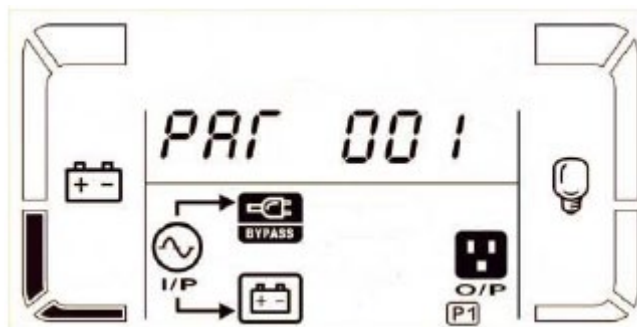

Interface	Setting
	<p>Parameter 2: you may choose Add or Sub to adjust inverter voltage</p> <p>Parameter 3: the voltage range is from 0V to 6.4V, the default value is 0V.</p>

Operating Mode / Status Description



If parallel UPS systems are successfully set up, it will show one more screen with “PAR” in parameter 2 and be assigned number in parameter 3 as shown below in the parallel screen diagram. The master UPS will be default assigned as “001” and slave UPS will be assigned as either “002” or “003”. The assigned numbers may be changed dynamically in the operation.









Operating mode/status		
AC mode	Description	When the input voltage is within acceptable range, UPS will provide pure and stable AC power to output. The UPS will also charge the battery in AC mode.
	LCD display	
ECO mode	Description	When the input voltage is within voltage regulation range and ECO mode is enabled, UPS will bypass voltage to output for energy saving.
	LCD display	
CVCF mode	Description	When input frequency is within 46 to 64Hz, the UPS can be set at a constant output frequency, 50 Hz or 60 Hz. The UPS will still charge battery under this mode.
	LCD display	
Battery mode	Description	When the input voltage is beyond the acceptable range or power failure, UPS will use backup power from battery and alarm will beep every 4 seconds.
	LCD display	
Bypass mode	Description	When input voltage is within acceptable range and bypass is enabled, turn off the UPS and it will enter Bypass mode. Alarm beeps every two minutes.
	LCD display	







Battery Test	Description	When UPS is in AC mode or CVCF mode, press “Test” key for more than 0.5s. Then the UPS will beep once and start “Battery Test”. The line between I/P and inverter icons will blink to remind users. This operation is used to check the battery status.	
	LCD display		
Fault status	Description	When UPS has fault happened, it will display fault messages in LCD panel.	
	LCD display		

Fault Code

Fault event	Fault code	Icon	Fault event	Fault code	Icon
Bus start failure	01	None	Negative power fault	1A	None
Bus over	02	None	Battery SCR short circuited	21	None
Bus under	03	None	Inverter relay short circuited	24	None
Bus unbalance	04	None	Parallel communication failure	35	None
Inverter soft start failure	11	None	Parallel output current unbalance	36	None
High Inverter voltage	12	None	Over temperature	41	None
Low Inverter voltage	13	None	CPU communication failure	42	None
Inverter output short circuited	14		Overload	43	

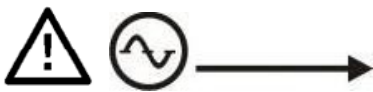

Warning Indicator







Warning	Icon (flashing)	Alarm
Battery low	 	Beeping every second
Overload	 	Beeping twice every second
Battery not connected	 	Beeping every second

Overcharge		Beeping every second
EPO enable		Beeping every second
Fan failure / Over temperature		Beeping every second
Charger failure		Beeping every second
I/P fuse blown		Beeping every second
Overload 3 times in 30 minutes		Beeping every second
Parallel Protection		Beeping every second

Troubleshooting

If the UPS system does not operate correctly, please solve the problem by using the table below.

Symptom	Possible cause	Remedy
No indication and alarm in the front display panel even though the mains is normal.	The AC input power is not connected well.	Check if input cable firmly connected to the mains.
The icon  and the warning code EP flash on LCD display and alarm beeps every second.	EPO function is enabled.	Set the circuit in closed position to disable EPO function.
The icon  and BATT.FAULT flash on LCD display and alarm beeps every second.	The external or internal battery is incorrectly connected.	Check if all batteries are connected well.
Fault code is shown as 28, the icon  lights on LCD display, and alarm beeps continuously.	Battery voltage is too low or the charger is fault.	Contact your dealer.

The icon  and  flash on LCD display and alarm beeps twice every second.	UPS is overload.	Remove excess loads from UPS output.
	UPS is overloaded. Devices connected to the UPS are fed directly by the electrical network via the Bypass.	Remove excess loads from UPS output.
	After repetitive overloads, the UPS is locked in the Bypass mode. Connected devices are fed directly by the mains.	Remove excess loads from UPS output first. Then shut down the UPS and restart it.
Fault code is shown as 43. The icon  lights on LCD display and alarm beeps continuously.	UPS is overload too long and becomes fault. Then UPS shut down automatically.	Remove excess loads from UPS output and restart it.
Fault code is shown as 14, the icon  lights on LCD display, and alarm beeps continuously.	The UPS shut down automatically because short circuit occurs on the UPS output.	Check output wiring and if connected devices are in short circuit status.
Fault code is shown as 1, 2, 3, 4, 5, 11, 12, 13, 1A, 21, 24, 35, 36, 41, or 42 on LCD display and alarm beeps continuously.	A UPS internal fault has occurred. There are two possible results: 1. The load is still supplied, but directly from AC power via bypass. 2. The load is no longer supplied by power.	Contact your dealer
Battery backup time is shorter than nominal value	Batteries are not fully charged	Charge the batteries for at least 7 hours and then check capacity. If the problem still persists, consult your dealer.
	Batteries defect	Contact your dealer to replace the battery.
The icon  and  flash on LCD display and alarm beeps every second.	Fan is locked or not working; or the UPS temperature is too high.	Check fans and notify dealer.

<p>The icon  and warning code 3F flash on LCD display and alarm beeps every second.</p>	<p>Loose parallel communication cable or incorrect parallel operation.</p>	<p>For parallel system, make sure parallel communication cable is connected tightly and also check if the PAR ID number is correct after turning on input breakers one at a time. If all the number displays are correct, it is okay to turn on the UPS after disabling the warning message by pressing 'UP' and 'DOWN' buttons at the same time. Otherwise, DO NOT turn on UPS and contact your dealer for assistance. For single UPS, since there is not communication cable and parallel output cable connection, simply ignore this warning message by pressing 'UP' and 'DOWN' buttons at the same time to disable, and turning on the UPS for continuous operation.</p>
---	--	---

Storage and Maintenance

Storage

Before storing, charge the UPS at least 7 hours. Store the UPS covered and upright in a cool, dry location. During storage, recharge the battery in accordance with the following table:

Storage Temperature	Recharge Frequency	Charging Duration
-25°C - 40°C	Every 3 months	1-2 hours
40°C - 45°C	Every 2 months	1-2 hours

Maintenance

- The UPS system operates with hazardous voltages. Repairs may be carried out only by qualified maintenance personnel.
- Even after the unit is disconnected from the mains, components inside the UPS system are still connected to the battery packs which are potentially dangerous.
- Before carrying out any kind of service and/or maintenance, disconnect the batteries and verify that no current is present and no hazardous voltage exists in the terminals of high capability capacitor such as BUS-capacitors.
- Only persons are adequately familiar with batteries and with the required precautionary measures may replace batteries and supervise operations. Unauthorized persons must be kept well away from the batteries.
- Verify that no voltage between the battery terminals and the ground is present before maintenance or repair. In this product, the battery circuit is not isolated from the input voltage. Hazardous voltages may occur between the battery terminals and the ground.
- Batteries may cause electric shock and have a high short-circuit current. Please remove all wrist watches, rings and other metal personal objects before maintenance or repair, and only use tools with insulated grips and handles for maintaining or repairing.

- When replace the batteries, install the same number and same type of batteries.
- Do not attempt to dispose of batteries by burning them. This could cause battery explosion. The batteries must be rightly deposited according to local regulation.
- Do not open or destroy batteries. Escaping electrolyte can cause injury to the skin and eyes. It may be toxic.
- Please replace the fuse only with the same type and amperage in order to avoid fire hazards.
- Do not disassemble the UPS system.

Batteries

The life of batteries used in these UPS products is estimated at 3-6 years depending on level of usage. Once the battery is no longer useful and must be replaced, please contact service personnel for assistance.

Replacing the Battery

(QUALIFIED SERVICE PERSONNEL ONLY)

CAUTION! Read and follow the IMPORTANT SAFETY INSTRUCTIONS before servicing the battery. Service the battery under the supervision of Qualified Service Personnel knowledgeable of batteries and their precautions.

CAUTION! Use only the specified type of battery. See your dealer for replacement batteries.

CAUTION! The battery may present risk of electrical shock. Do not dispose of batteries in a fire as it may explode. Follow all local ordinances regarding proper disposal of batteries.

CAUTION! Do not open or mutilate the batteries. Released electrolyte is harmful to skin and eyes and may be toxic.

CAUTION! Although the battery system voltage is only 12VDC and 24VDC, the battery can present a high risk of short circuit current and electrical shock. The short circuit current capability of the battery is sufficient to burn wire or tools very rapidly, producing molten metal. Observe these precautions when replacing the battery:

1. Remove all watches, rings or other metal objects.
2. Only use tools with insulated handles.
3. Do not lay tools or metal parts on top of battery or any terminals.
4. Wear protective eye wear (goggles), rubber gloves, and boots.
5. Disconnect the charging source before connecting or disconnecting the battery terminals.
6. Determine if the battery is inadvertently grounded. If inadvertently grounded, remove the source of the ground. Contact with a grounded battery can result in electrical shock! The likelihood of such shock will be reduced if such grounds are removed during installation and maintenance (applicable to a UPS and a remote battery supply not having a grounded circuit).

Specifications

MODEL NUMBER		NXRi-6KL	NXRi-10KL
INPUT	Capacity	6000VA (4800W)	10000VA (8000W)
	Voltage	230VAC	
	Frequency	50/60Hz ± 3%	
	Power factor	≥ 0.99	
	Harmonic distortion	≤ 6% THD non-linear load	
OUTPUT	Voltage	230VAC (default) configurable to 208/220/240VAC single-phase ± 1%	
	Frequency	50/60Hz ± 0.1	
	Power factor	0.8	
	Overload protection	98% ECO mode, > 90% online mode	
	Efficiency	110% for 10 min; 130% for 1 min; > 130% for 1 sec	
BATTERY	Battery type (EBP20)	(20) 12V 9AH	
	Charge current	2A	
PHYSICAL	UPS dimensions (W x D x H)	438 x 580 x 133 mm (17.2 x 22.8 x 5.2 in)	438 x 668 x 133 mm (17.2 x 26.3 x 5.2 in)
	UPS weight	17 kg (37.5 lbs)	20 kg (44.0 lbs)
	EBP dimensions (W x D x H)	438 x 580 x 133 mm (17.2 x 22.8 x 5.2 in)	
	EBP weight	63 kg (138.9 lbs)	
	Input/output	Hardwired terminal	
ENVIRONMENT	Temperature	0–40°C (32–104°F)	
	Humidity	0–95% non-condensing	
	Audible noise	< 50dBA	
	Altitude	3500 m (11,500 ft) above sea level	
APPROVALS	CE, EN/IEC 62040-2, EN/IEC 62040-1, RoHS compliant		
WARRANTY	2 years electronics, 2 years battery		
COMMUNICATIONS INTERFACE	USB/RS232, EPO, SNMP (optional), and Modbus cards		
INCLUDED IN BOX	User manual, monitoring software, CD, USB cable		
AVAILABLE OPTIONS	SNMP card, AS400 card, EBP20, rail kit		

Battery Runtimes

Model	Battery Configuration	Load Level			
		25%	50%	75%	100%
NXRi-6KL	WITH (1) NXRi-EBP20	56	23	14	10
	WITH (2) NXRi-EBP20	137	56	34	23
	WITH (3) NXRi-EBP20	230	95	56	39
	WITH (4) NXRi-EBP20	332	137	81	56
NXRi-10KL	WITH (1) NXRi-EBP20	29	12	7	5
	WITH (2) NXRi-EBP20	71	29	17	12
	WITH (3) NXRi-EBP20	120	49	29	20
	WITH (4) NXRi-EBP20	173	71	42	29

Shipping List (UPS)

1. (1) UPS
2. (1) User and Installation Manual
3. (1) USB cable
4. (1) ViewPower CD (monitoring software)
5. (1) Parallel Cable kit (NXRi-10KL only)

Shipping List (EBP20)

1. (1) EBP
2. (1) DC-DC cable to connect from UPS to EBP

Obtaining Service

If the UPS requires Service:

1. Use the TROUBLESHOOTING section in this manual to eliminate obvious causes.
2. Verify there are no circuit breakers tripped.
3. Call your dealer for assistance. If you cannot reach your dealer, or if they cannot resolve the problem, call Xtreme Power Conversion Corp Technical Support at 800.582.4524. Technical support inquiries can also be made at support@xpcc.com. Please have the following information available BEFORE calling the Technical Support Department:
 - Your name and address.
 - The serial number of the unit.
 - Where and when the unit was purchased.
 - All of the model information about your UPS.
 - Any information on the failure, including LED's that may or may not be illuminated.
 - A description of the protected equipment, including model numbers if possible.
 - A technician will ask you for the above information and, if possible, help solve your problem over the phone. In the event that the unit requires factory service, the technician will issue you a Return Material Authorization number (RMA).

If you are returning the UPS to Xtreme Power for service, please follow these procedures:

1. Pack the UPS in its original packaging. If the original packaging is no longer available, ask the Technical Support Technician about obtaining a replacement set of packaging material. It is important to pack the UPS properly in order to avoid damage in transit. Never use Styrofoam beads for a packing material.
2. Include a letter with your name, address, daytime phone number, RMA number, a copy of your original sales receipt, and a brief description of the problem.
3. Mark the RMA number on the outside of all packages. Xtreme Power cannot accept any package without the RMA number marked on the outside of the boxes.
4. Return the UPS by insured, prepaid carrier to the address provided by the Technician.
5. Refer to the Warranty statements in this manual for additional details on what is covered.