



NP10-6 NP10-6FR

Sealed Rechargeable
Lead-Acid Battery

6V, 10Ah

Specifications

- **NOMINAL VOLTAGE:** 6V
- **NOMINAL CAPACITY:**
 - 20 hr. rate of 0.50A to 5.25V 10.0Ah
 - 10 hr. rate of 0.93A to 5.25V 9.3Ah
 - 5 hr. rate of 1.70A to 5.10V 8.5Ah
 - 1 hr. rate of 6.00A to 4.80V 6.0Ah
- **WEIGHT (approx.):** 4.41 pounds (2.0 kgs.)
- **ENERGY DENSITY (20 hr. rate):** 1.40 WH/cubic inch (85 WH/liter)
- **SPECIFIC ENERGY (20 hr. rate):** 13.6 WH/pound (30.0 WH/kg)
- **INTERNAL RESISTANCE OF CHARGED BATTERY:** 10 milliohms (approx.)
- **MAXIMUM DISCHARGE CURRENT WITH STANDARD TERMINALS:** 40 amperes
- **MAXIMUM SHORT-DURATION DISCHARGE CURRENT:** 300 amperes
- **OPERATING TEMPERATURE RANGE:**
 - CHARGE 5°F to 122°F (-15°C to 50°C)
 - DISCHARGE -4°F to 140°F (-20°C to 60°C)
- **CHARGE RETENTION (shelf life) at 68°F (20°C):**
 - 1 month 97%
 - 3 months 91%
 - 6 months 85%
- **LIFE EXPECTANCY:**
 - STANDBY USE** 3 to 5 years
 - CYCLE USE (approx.):**
 - 100% depth of discharge 250 cycles
 - 50% depth of discharge 550 cycles
 - 30% depth of discharge 1200 cycles
- **SEALED CONSTRUCTION:** Can be operated in any position without leakage.
- **STANDARD TERMINAL:** Quick Disconnect .187 or Optional .250
- **HOUSING MATERIAL:** ABS Resin
- **OPTIONAL:** Container and cover made from Flame Retardant ABS (UL94-V0/L.O.I.>28%)

Terminal

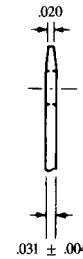
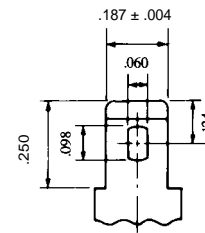

INCH = MM	
.250	6.35
.185	4.70
.124	3.15
.098	2.49
.060	1.52
.031	0.79
.020	0.51
.004	0.10

Dimensions

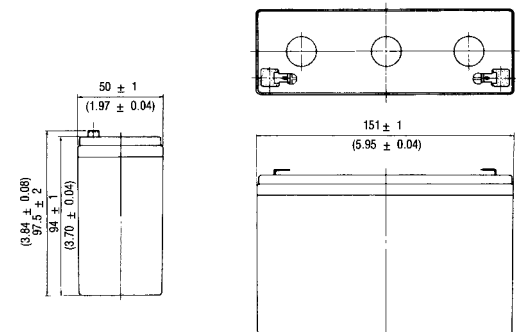

DIMENSIONS: MM (INCHES)



RECOGNIZED BY UL, File No. MH 16464

EnerSys™

Power/Full Solutions™

DISCHARGE CHARACTERISTIC CURVES AT 25°C (77°F)

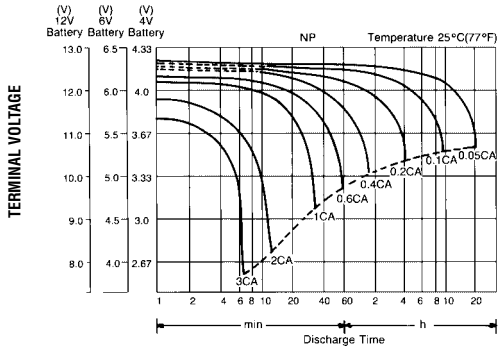

TEMPERATURE EFFECTS IN RELATION TO BATTERY CAPACITY

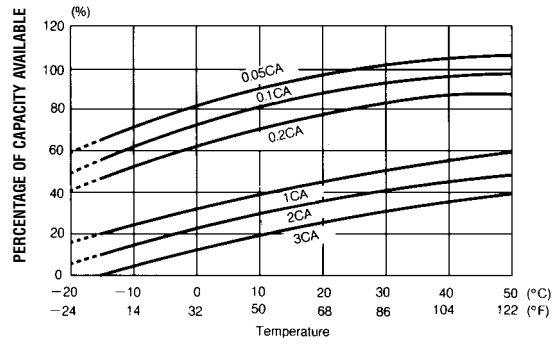

SELF DISCHARGE CHARACTERISTICS

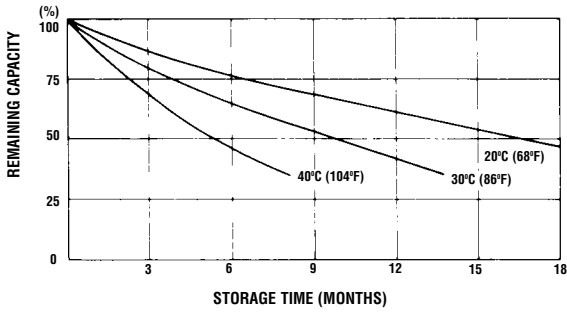

OPEN CIRCUIT VOLTAGE VS REMAINING CAPACITY

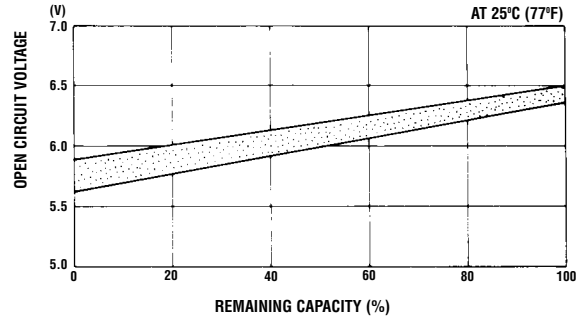

CYCLE SERVICE LIFE IN RELATION TO DEPTH OF DISCHARGE

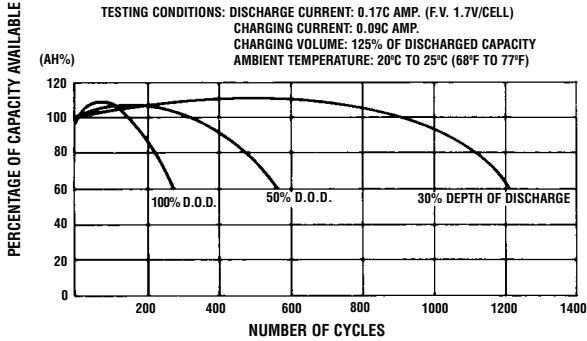

FLOAT SERVICE LIFE

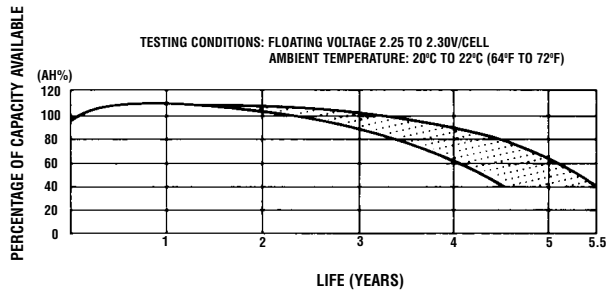

When the battery will be used by current in excess of 30A, consult with EnerSys, Inc. prior to use.

CHARGING METHODS (At 20°C)

Cycle use: Maximum charging current 2.5A
Charging voltage 7.2 to 7.5V

Standby use: Float charging voltage 6.75 to 6.90V

CAUTION

- Avoid short circuit
- Do not charge in a sealed container.



EnerSys Inc.
P.O. Box 14145
Reading, PA 19612-4145
USA
Tel: +1-610-208-1991
+1-800-538-3627

EnerSys EMEA
Brussels, Belgium
Tel: +32 (0)2 247 94 47
EnerSys Asia
Guandong, China
Tel: +86 755 2689 3639

Represented by: